

# APstorage Sea Family ELS Series PCS Installation & User Manual

(For EMEA)



# Table of Contents

<b>1. Important Safety Instructions</b> .....	<b>2</b>
1.1 Safety Instructions .....	2
1.2 Radio Interference Statement .....	2
1.3 Communication Disclaimer .....	3
1.4 Symbols replace words on the equipment, on a display, or in manuals .....	3
<b>2. APstorage PCS Introduction</b> .....	<b>4</b>
2.1 Dimensions .....	4
2.2 Basic System Architecture .....	5
2.3 LED .....	6
2.4 PCS Connection Port .....	7
<b>3. Installation</b> .....	<b>8</b>
3.1 Packing List .....	8
3.2 Select Mounting Location .....	9
3.3 PCS Installation Steps .....	10
3.4 PCS Wiring .....	11
3.4.1 DC Wiring .....	12
3.4.2 AC Wiring .....	12
3.4.3 Communication Wiring .....	13
3.4.4 CT Wiring .....	14
3.5 Install the Lower Cover .....	15
3.6 PV System to APstorage Pairing .....	16
3.7 Wiring Diagram .....	17
3.8 Parallel Wiring Diagram .....	18
3.9 PCS Parallel Wiring Steps .....	19
3.10 Start-up sequence .....	20
3.10.1 Power ON .....	20
3.10.2 Check the system .....	20
3.10.3 Power Off .....	20
<b>4. APstorage User Interface</b> .....	<b>21</b>
4.1 Configure APstorage with EMA Manager .....	21
4.2 Home Page .....	23
4.3 Module .....	25
4.4 Data .....	26
4.5 Workbench .....	29
4.6 Settings .....	46
<b>5. Technical Data</b> .....	<b>47</b>
<b>6. Contact Information</b> .....	<b>48</b>

# 1. Important Safety Instructions

This manual contains important instructions to be followed during installation and maintenance of the APstorage PCS. To reduce the risk of electrical shock and ensure the safe installation and operation of the APstorage PCS, the following symbols appear throughout this document to indicate dangerous conditions and important safety instructions.



**DANGER:** This indicates a hazardous situation, which if not avoided, will result in death or serious injury.



**WARNING:** This indicates a situation where failure to follow instructions may be a safety hazard or cause equipment malfunction. Use extreme caution and follow instructions carefully.



**NOTE:** This indicates information that is very important for optimal system operation. Follow instructions closely.

---

## 1.1 Safety Instructions

**IMPORTANT SAFETY INSTRUCTIONS. SAVE THESE INSTRUCTIONS.** This guide contains important instructions that you must follow during installation and maintenance of the PCS. Failing to follow any of these instructions may void the warranty. Follow all of the instructions in this manual. These instructions are key to the installation and maintenance of the APstorage PCS. These instructions are not meant to be a complete explanation of how to design and install APstorage PCSs. All installations must comply with national and local electrical codes and standards.



**DANGER:**

- Only qualified professionals should install and/or replace the APstorage PCS.
- Perform all electrical installations in accordance with local codes.
- To reduce risk of burns, do not touch the body of the PCS.



**WARNING:**

- Do NOT attempt to repair the APstorage PCS. If it shows abnormal performance, Contact APsystems Customer Support to obtain adequate support. Damaging or opening the APstorage PCS will void the warranty.



**NOTE:**

- Before installing or using the APstorage PCS, please read all instructions and Cautionary markings in the technical documents and on the APstorage PCS.

---

## 1.2 Radio Interference Statement

This equipment could radiate radio frequency energy which might cause interference to radio communications if you do not follow the instructions when installing and using the equipment. But there is no guarantee that interference will not occur in a particular installation. If this equipment causes interference to radio or television reception, the following measures might resolve the issues:

- Relocate the receiving antenna and keep it well away from the equipment.
- Consult the dealer or an experienced radio / TV technician for help.

Changes or modifications not expressly approved by the party responsible for compliance may void the user's authority to operate the equipment.

# 1. Important Safety Instructions

## 1.3 Communication Disclaimer

The EMA system provides a friendly interface to monitor the working status of the whole energy storage system. At the same time, it can also help to locate problems during system maintenance. If communication has been lost for more than 24 hours, please contact the technical support of APsystems.

## 1.4 Symbols replace words on the equipment, on a display, or in manuals

---

 **APstorage** Trademark.

---



Caution, risk of electric shock.

---



Caution, hot surface.

---



NOTICE, danger! This device directly connected with electricity generators and public grid.

---

### **Qualified personnel**

Person adequately advised or supervised by an electrically skilled person to enable him or her to perceive risks and to avoid hazards which electricity can create. For the purpose of the safety information of this manual, a "qualified person" is someone who is familiar with requirements for safety, electrical system and EMC and is authorized to energize, ground, and tag equipment, systems, and circuits in accordance with established safety procedures. The inverter and storage system may only be commissioned and operated by qualified personnel.

---

## 2. APstorage PCS Introduction

**ELS series PCS is APstorage's Sea family product and the PCS is a battery Power Conversion System.**

APsystems PCS, together with a compatible battery ( not offered by APsystems), becomes a complete and independent AC coupling storage solution for residential PV installations. It can be used with any new or already installed PV systems without changing equipment in place.

### Power Conversion System (PCS)



One PCS can be connected up to 20kWh compatible battery (see battery compatibility list). When multiple battery packs are connected, they need to be connected in parallel .(see connection diagram in the Battery User Manual)

APstorage will help home-owners to optimize their utility bill, offering full flexibility to manage their Electrical consumption. Several modes are available. (Backup power supply mode, Self-consumption mode and Advanced mode)

### 2.1 Dimensions

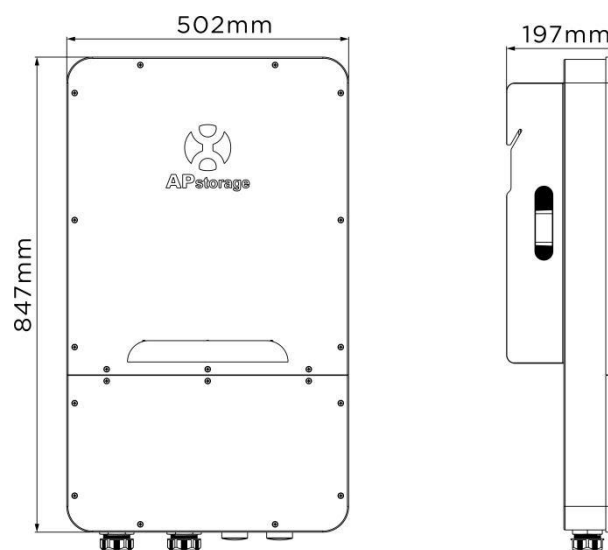

## 2. APstorage PCS Introduction

### 2.2 Basic System Architecture

A typical APstorage system includes two main elements:

- **APstorage PCS, which is a smart battery Power Conversion System.**

The PCS includes an integrated ECU (Energy Communication Unit) to ensure monitoring of the overall system once up and running.

- **a compatible Battery pack (see battery compatibility list).**

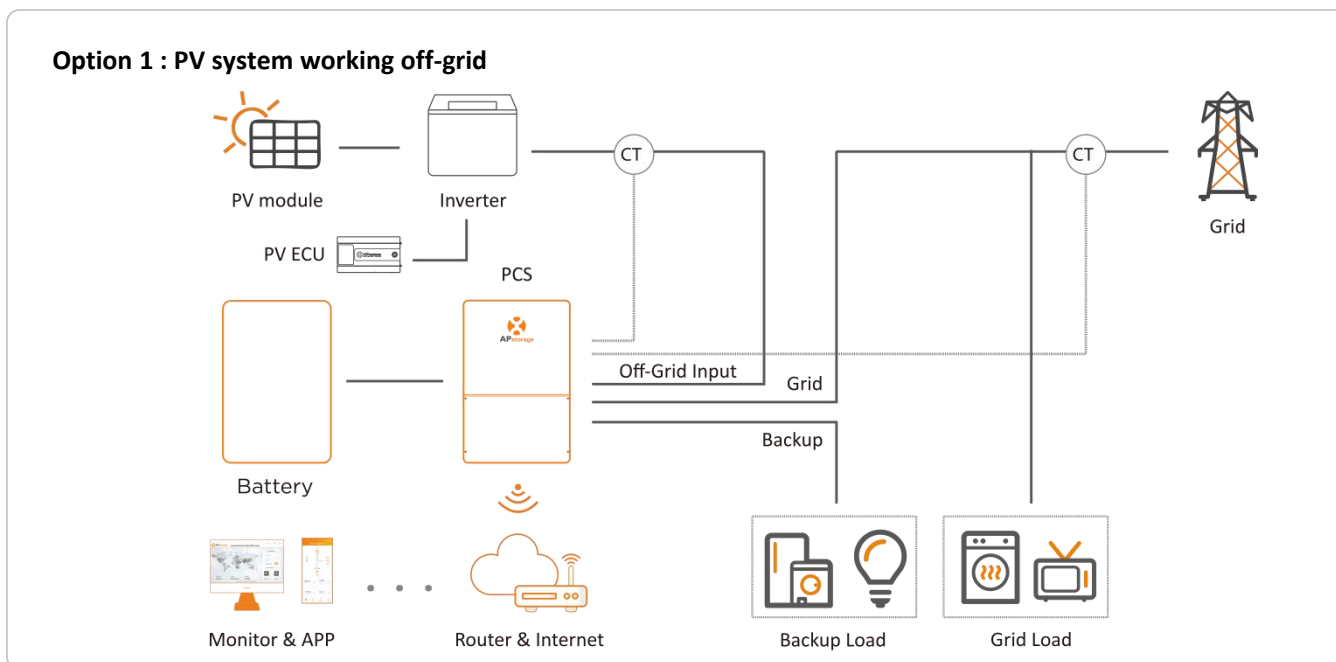

In Option 1, Off grid function only compatible with APsystems DS3&DS3D microinverters (fully compatible).

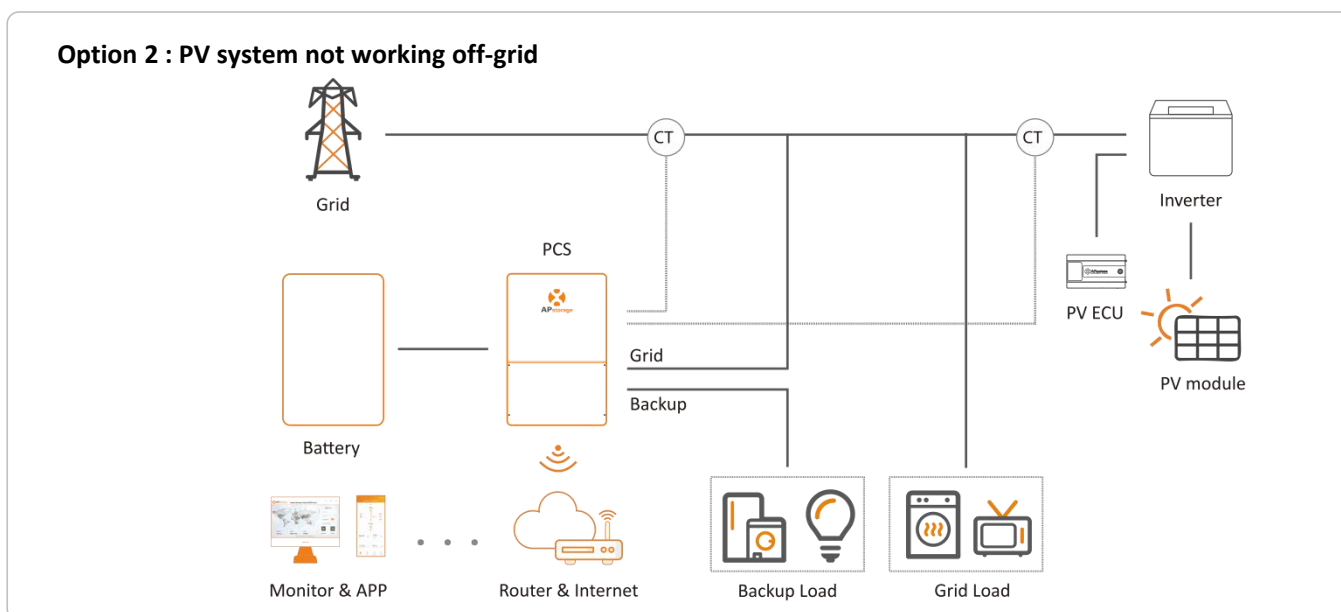

**Option 3 : mix of option 1 and 2 following the conditions above**

**NOTE:** In a Storage System with APstorage PCS, the battery is one of the key components. Therefore, it is necessary to keep the installation environment well ventilated, please refer to Battery user manual.

## 2. APstorage PCS Introduction

### 2.3 LED

There are eight LED indicators on the PCS unit, indicating the working state of the PCS.



LED	Condition	Description
SYSTEM	Light on constantly	The system is operating
	Light flashing	The system is starting up
	Light off	The system shutdown
GRID	Light on constantly	The grid exists and is connected
	Light flashing	The grid exists but is not connected
	Light off	The grid does not exist
BACK UP	Light on constantly	The backup system is operating
	Light off	The backup is off
ENERGY	Light on constantly	Buy energy from grid
	Light flashing 1	Zero output
	Light flashing 2	Supplying energy to grid
	Light off	The grid is not connected or system is not operating
BATTERY	Light on constantly	The battery is charging
	Light flashing 1	The battery is discharging
	Light flashing 2	The battery SOC is low
	Light off	The battery is disconnected
WI-FI	Light on constantly	The WiFi is connected to the router
	Light flashing 1	The WiFi is not connected to the router
	Light off	The WiFi function is closed
COM	Light on constantly	The battery and the internet communication are normal
	Light flashing 1	The battery communication is normal, but the internet communication is abnormal
	Light flashing 2	The battery communication is abnormal, but the internet communication is normal
	Light off	The battery and the internet communication are abnormal
FAULT	Light on constantly	Fault has occurred
	Light flashing	Back up output overload
	Light off	No fault



**NOTE:** Light flashing 1: Every 5 seconds light on for 1 second.  
Light flashing 2: Every 2 seconds light on for 1 second.

## 2. APstorage PCS Introduction

### 2.4 PCS Connection Port

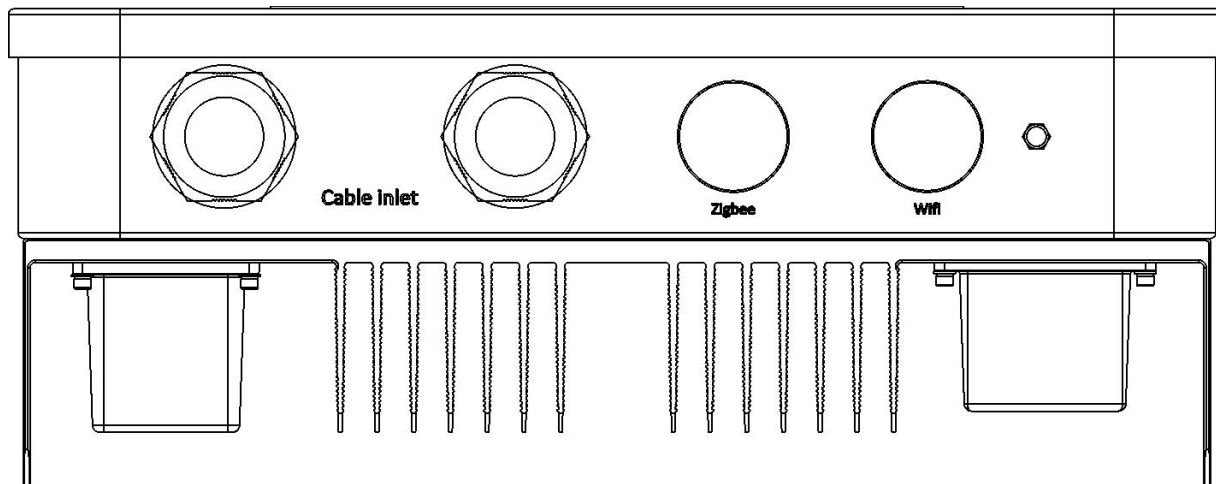

(Bottom view of PCS)

#### **Cable Inlet:**

- ① DC cable: Connect the positive and negative terminals of the battery.
- ② AC cable: AC grid port is connected to power grid and AC backup port is off grid output.
- ③ Internet cable: Connect the Internet port into the router.
- ④ CT cable: Connect the PV CT or Grid CT cable to the PCS.

(Both cable ports are available)

#### **Zigbee:**

Use for Zigbee communication.



#### **Wifi:**

Use for Wifi communication.

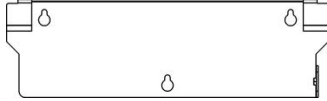
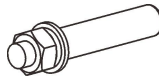
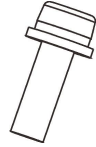
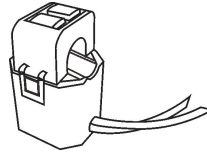

# 3. Installation

## 3.1 Packing List

KITS	PICTURES
PCS	 <p>×1</p>
Wall-mounted Bracket	 <p>×1</p>
Expansion screw (M8*70)	 <p>×3</p>
Fixing screw (M6×22)	 <p>×1</p>
CT (Current transformer)	 <p>×2 (grid CT and PV CT)</p>
Installation / User Manual	 <p>×1</p>



**NOTE:** The expansion screws are applicable only to cement concrete walls. For other types of walls, install expansion screws based on the wall type.



**NOTE:** The customer will need to purchase a combiner box for parallel connection of the batteries. Combiner box requirements: rated current of each connector  $\geq 100A$ .

# 3. Installation

## 3.2 Select Mounting Location

1. PCS should be installed on a solid surface, where is suitable for PCS's dimensions and weight.
2. Do not install PCS in a confined space with no ventilation.
3. If the PCS is installed outside, it should be protected under shelter from direct sunlight or bad weather conditions (like snow, rain, lightning, etc). Fully shielded installation locations are preferred.

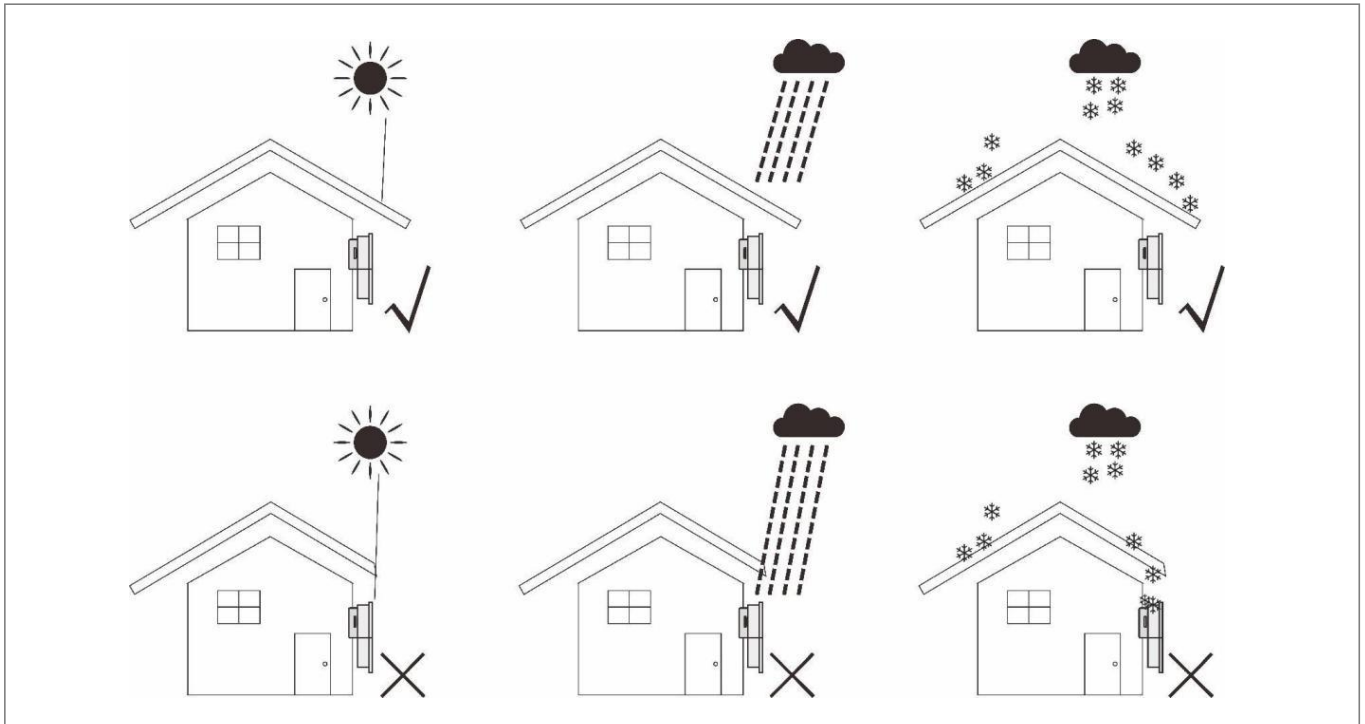

4. Install the APstorage vertically on the wall.
5. Make sure that the PCS is mounted "face-up": Product logo is visible after installation.
6. Leave enough space around APstorage. The specific requirements are as follows:

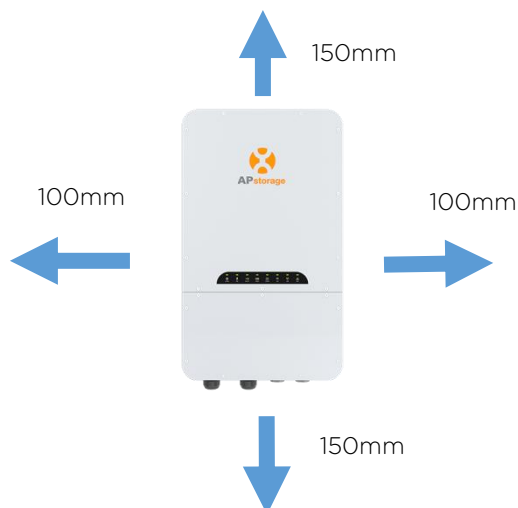

**WARNING:** APstorage PCS cannot be installed near flammable, explosive or strong electro-magnetic equipment.

# 3. Installation

## 3.3 PCS Installation Steps

- ① Mark the holes position on the wall and drill holes according to wall type and expansion screws type. The configured expansion screw is drilled with a diameter of 12mm(0.5") and a depth of 50-55mm(1.9-2.2").
- ② Put the expansion screws into the holes on the wall. Use a wrench to tighten the hex nuts, so that the expansion screws sleeve are fully expanded. Then remove the hex nuts. Hang the wall mounting bracket into the expansion screws, and use the hex nuts to fix it firmly. Make sure that the wall mounting bracket is horizontal after installation.

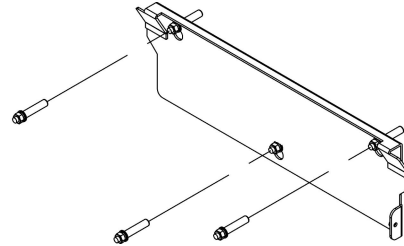
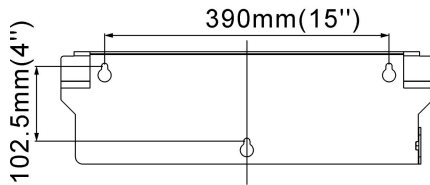

- ③ Lift the PCS to hang it into the wall mounting bracket, and fix the PCS on wall mounting bracket with the M6×22mm screw.

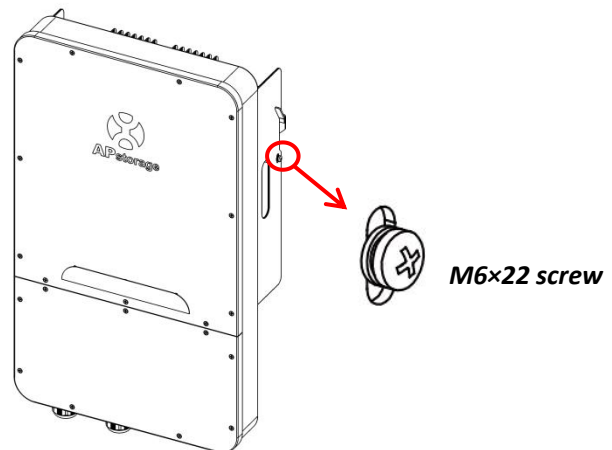
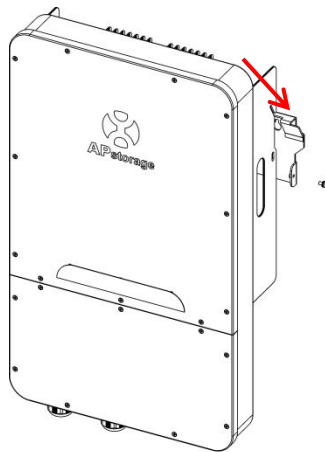

# 3. Installation

## 3.4 PCS Wiring

When wiring, you need to remove the lower cover first, just unscrew the 9 locking screws.

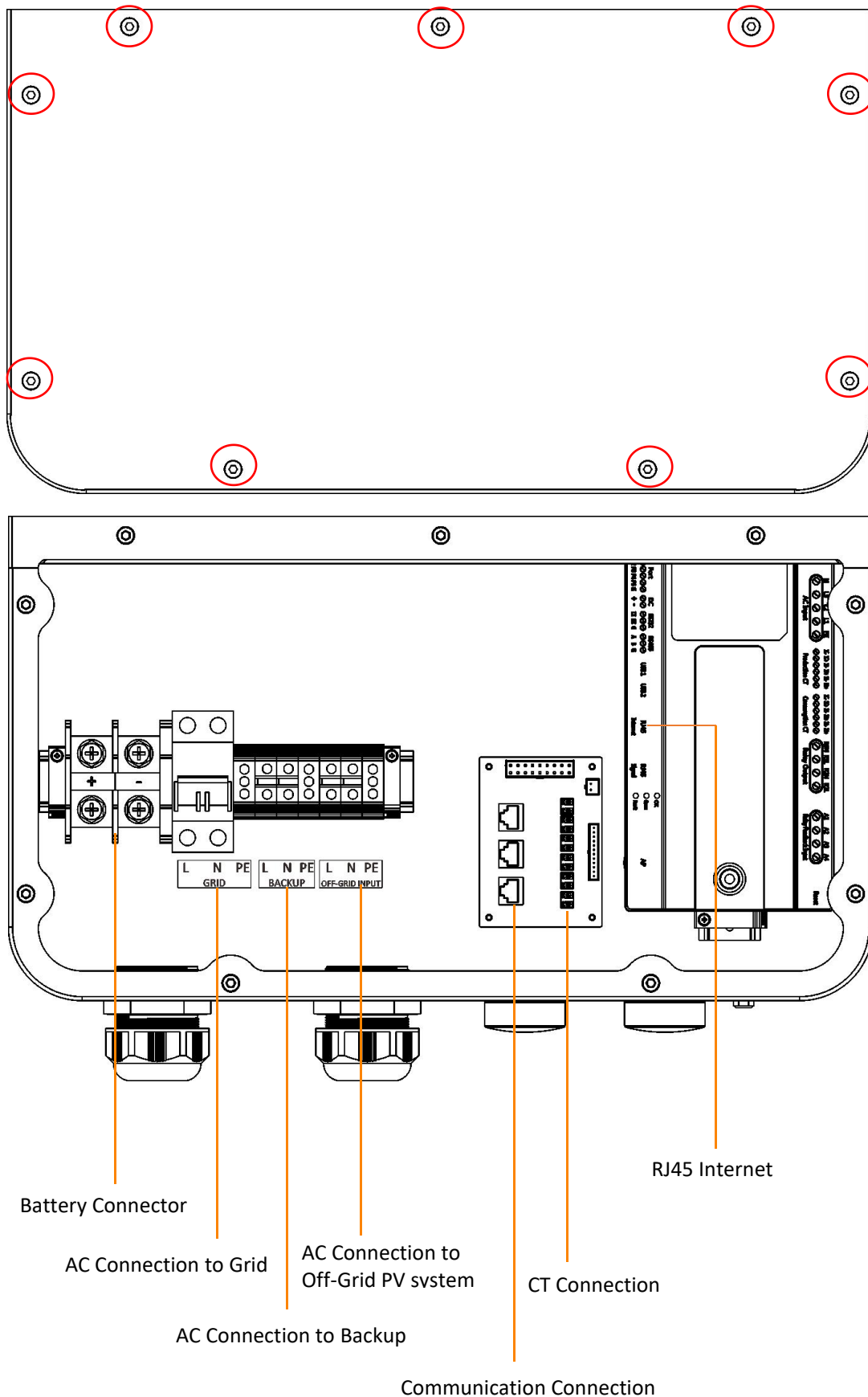

# 3. Installation

When wiring, you need to crimp appropriate terminals on the cable (as shown for dimensions). The cables and terminals need to be prepared by yourself or purchased from APsystems.

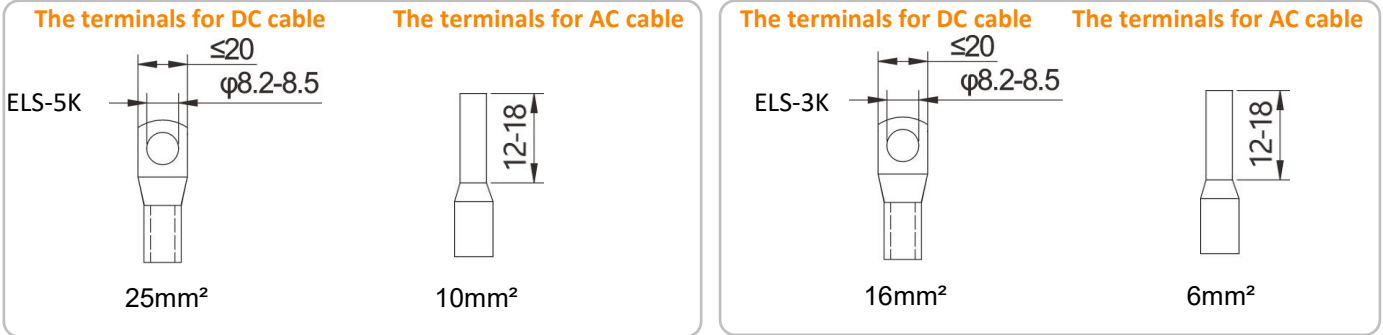

**ELS-5K recommend minimum cable:** DC cable 25mm<sup>2</sup> / AC cable option 1 or 3 : 10 mm<sup>2</sup>, option 2 : 4mm<sup>2</sup> (see chap 2.2)

**ELS-3K recommend minimum cable:** DC cable 16mm<sup>2</sup> / AC cable option 1 or 3 : 6 mm<sup>2</sup>, option 2 : 4mm<sup>2</sup> (see chap 2.2)

PCS has been installed with cable glands before delivery. If connection is required through pipe (**prepare pipe yourself**), remove cable glands on the BOX first.

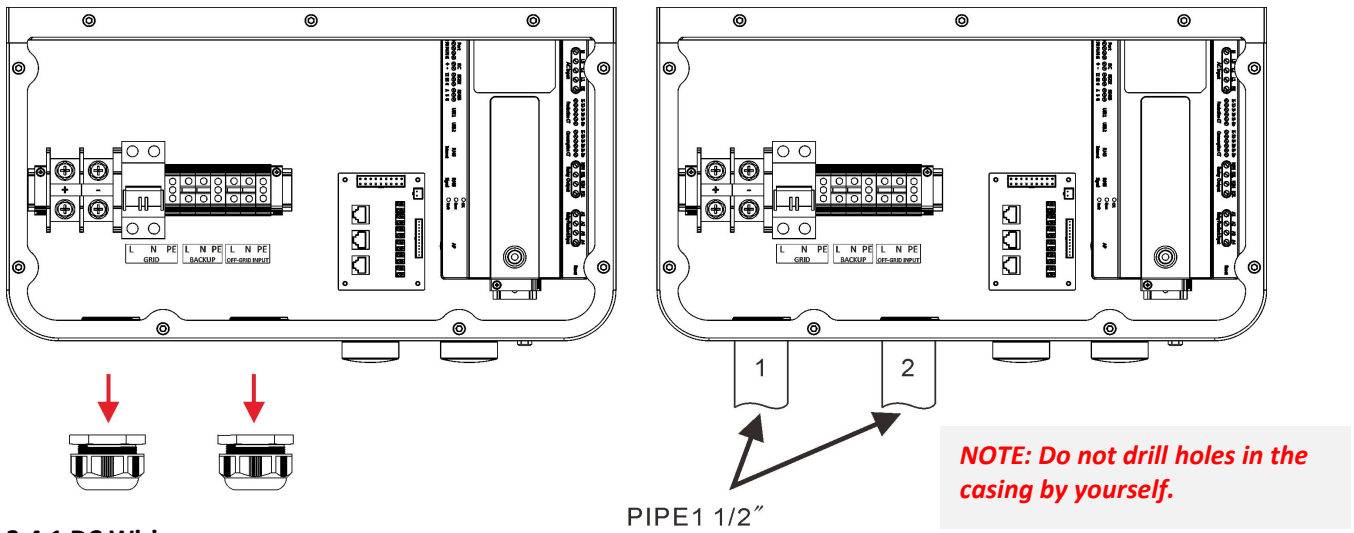

### 3.4.1 DC Wiring

Connect the DC cable to the PCS through the cable gland. As shown, connect wire + & - to Battery connector.

Torque value: 40lb.in

### 3.4.2 AC Wiring

3.4.2.1 Connect the grid AC cables to the PCS through the cable gland. As shown, connect wire L and N to grid breaker, connect wire PE to the earth terminal block.

Torque value: 10.53lb.in

**NOTE: Do not loosen the screw to the end when removing wires, otherwise the terminal may be damaged.**

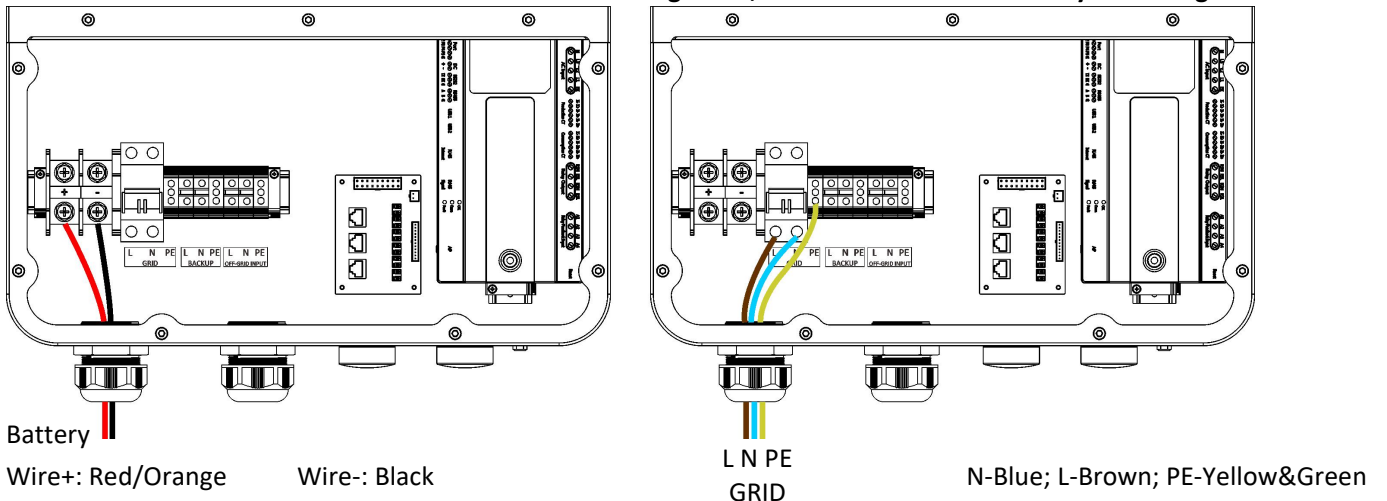

# 3. Installation

3.4.2.2 Connect the backup AC cables to the PCS through the cable gland. As shown, connect wire L and N to the terminal block, and connect wire PE to the earth terminal Block.

*Torque value: 10.53lb.in*

**NOTE: Do not loosen the screw to the end when removing wires, otherwise the terminal may be damaged.**

3.4.2.3 Connect the Off-Grid PV AC cables to the PCS through the cable gland. As shown, connect wire L and N to terminal Block, and connect wire PE to the earth terminal Block.

*Torque value: 10.53lb.in*

**NOTE: Do not loosen the screw to the end when removing wires, otherwise the terminal may be damaged.**

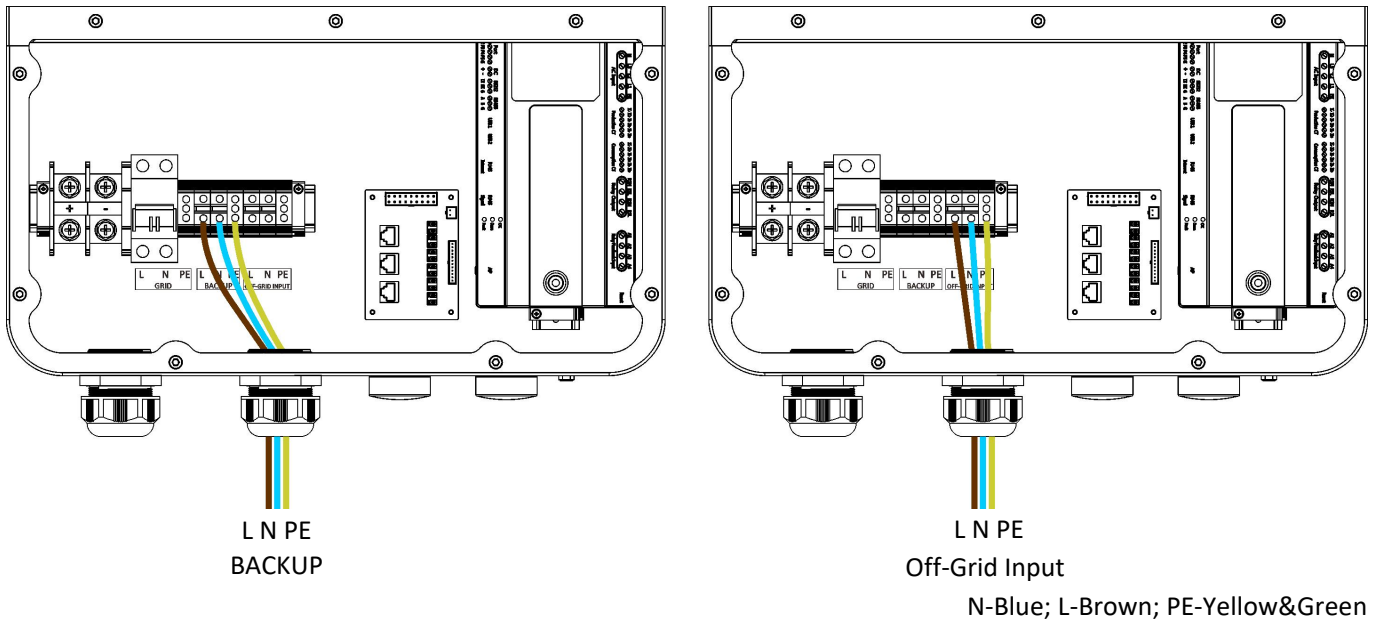

**NOTE:** Make sure to connect the live wire to L, connect the neutral wire to N, otherwise the precision of the CT will be affected.

## 3.4.3 Communication Wiring

### 3.4.3.1 Internet Communication

Using the Internet cable, connect the Internet port into the router. The PCS also can be connected to the router via Wi-Fi, please refer to the chapter 4.5.3.1.

### 3.4.3.2 Battery Communication

Connect the Battery's RJ45 port to PCS's RJ45 port.

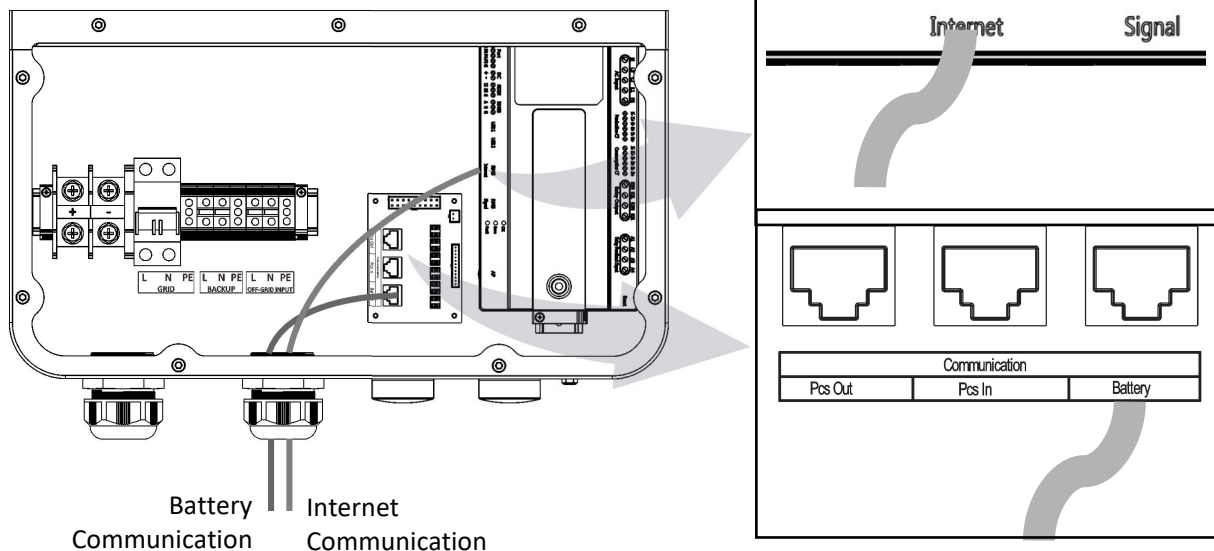

# 3. Installation

## 3.4.4 CT Wiring

Connect the PV CT cable to the PV CT port of the PCS. Connect the GRID CT cable to the GRID CT port of the PCS.

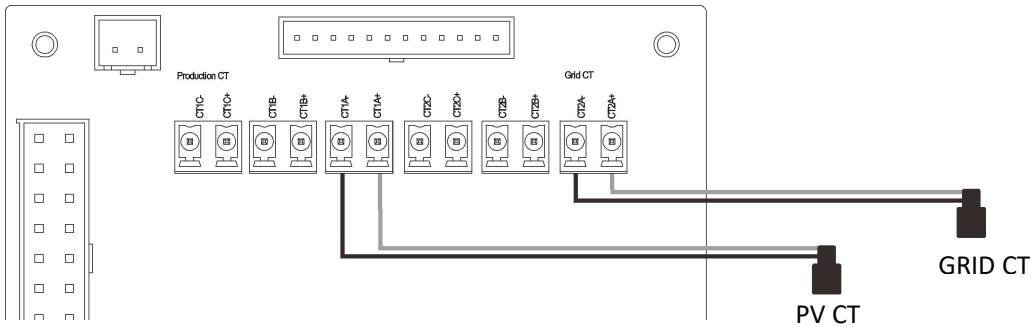

*The direction of CTs: The arrows on the GRID CT should point from grid to distribution box and the arrows on the PV CT from distribution box to PV.*

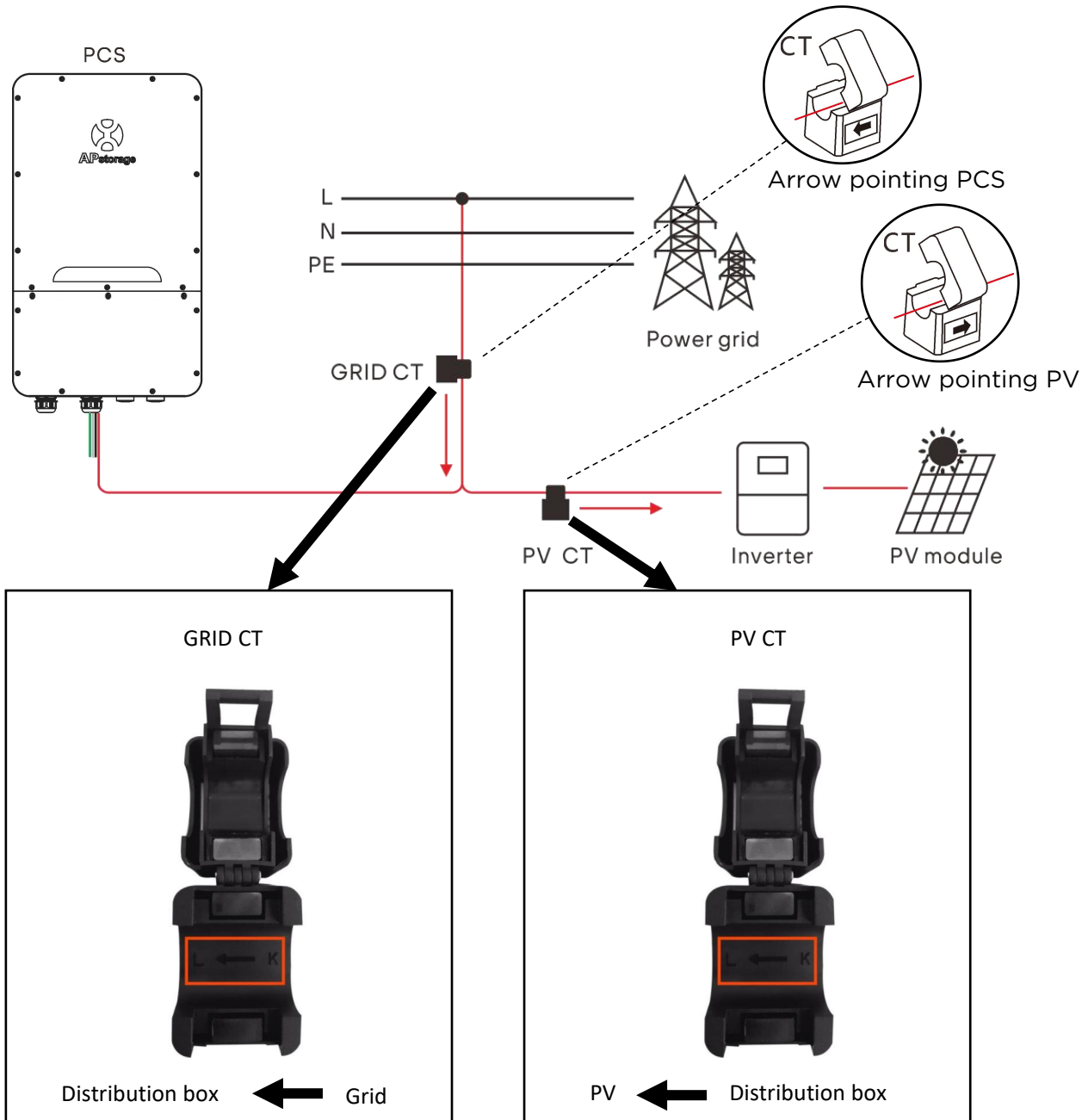

## 3. Installation

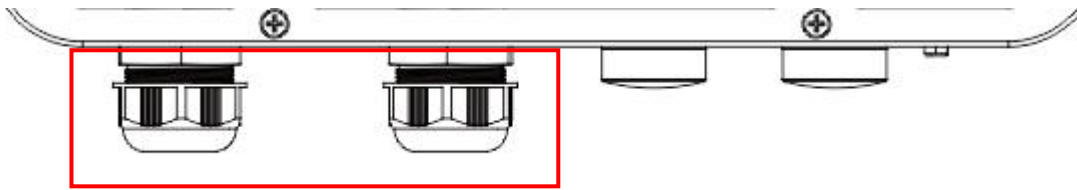

**i**

**NOTE:** After having completed the wiring, the nuts of the cable gland must be tightened.

### 3.5 Install the Lower Cover

As shown, screw the 9 screws back.

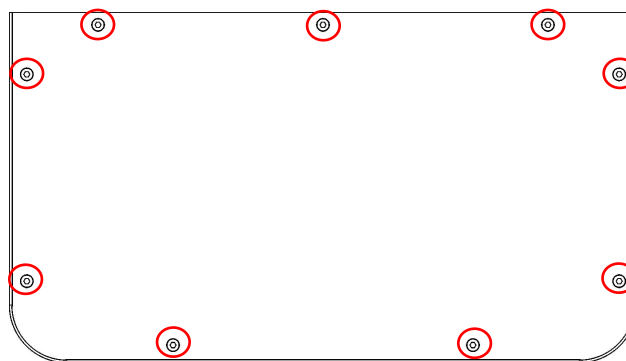



## 3. Installation

### 3.6 PV System to APstorage Pairing

1. Identify the largest maximum single load power rating (kW) that you want to backup, and select the absolute minimum number of PCS units required to meet the 2017 NEC 690.10->710.15(A) requirements. A maximum of 2 ELS 5K units can be connected in parallel.
2. Based on the estimated backup loads for the user defined time period, calculate the required energy storage (kWh) capacity and the minimum number of battery required.
3. Refer the Table 1 to calculate the maximum PV system power (PV system 1) to connect to the backup side, if the total PV system power is larger than Max PV system power, connect the excess power (PV system 2) to the grid side.

**Table 1: Maximum PV system power for storage system for backup operation**

ELS-5K units	Battery units	Max PV system power (kWac)
1	1	3.12
1	>=2	6.25
2	2	6.25
2	3	9.37
2	>=4	12.5

ELS-3K units	Battery units	Max PV system power (kWac)
1	1	3.12
1	>=2	4.6
2	2	6.25
2	3	9.2

# 3. Installation

## 3.7 Wiring Diagram

█ DC+   
 █ DC-   
 █ L wire   
 █ N wire   
 █ PE wire

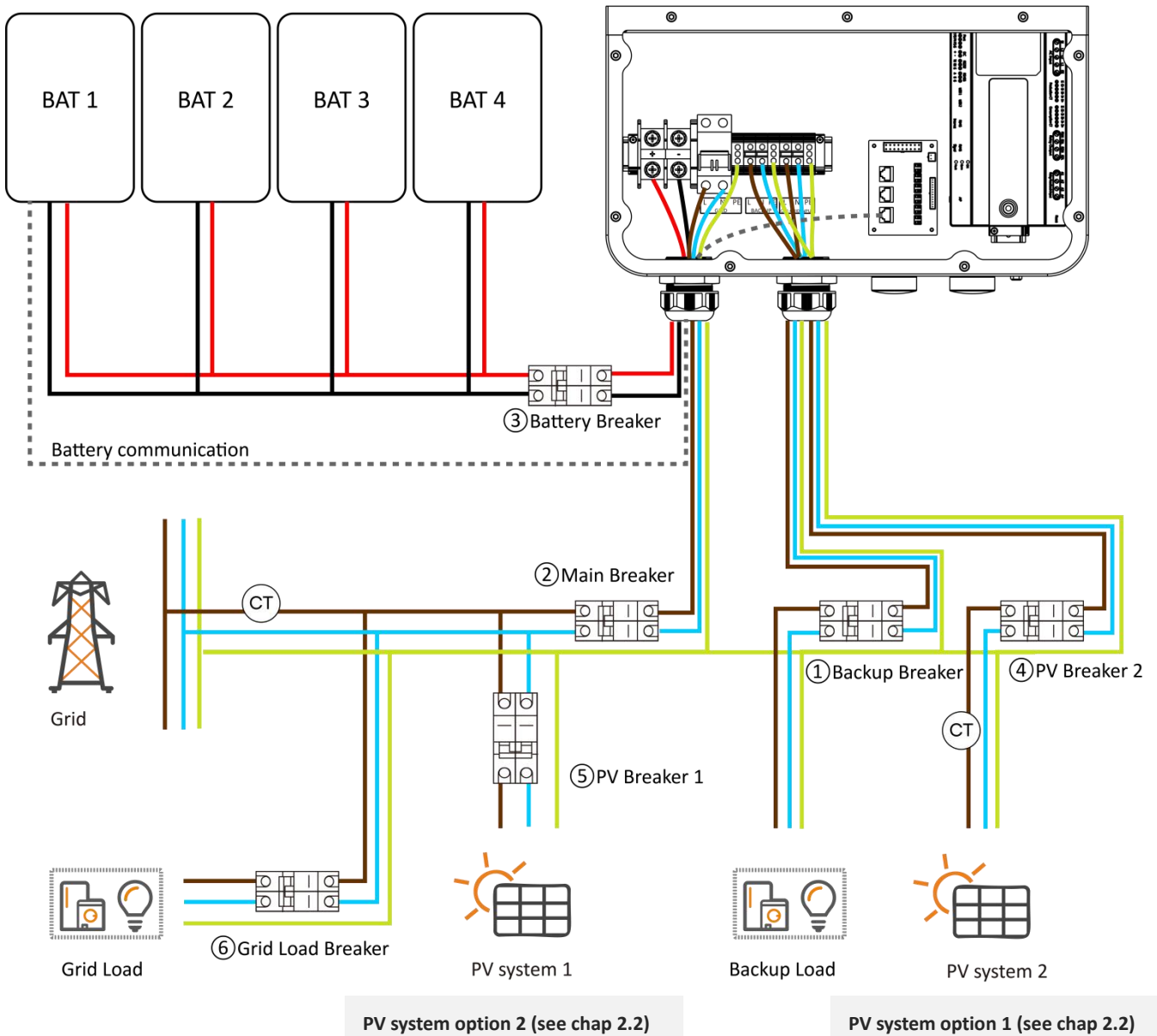

### ELS-5K:

- ① Backup Breaker: 32A AC Breaker
- ② Main Breaker : 63A AC Breaker
- ③ Battery Breaker: 125A DC Breaker
- ④ PV Breaker 2: 32A AC Breaker

### ELS-3K:

- ① Backup Breaker: 25A AC Breaker
- ② Main Breaker : 50A AC Breaker
- ③ Battery Breaker: 100A DC Breaker
- ④ PV Breaker 2: 25A AC Breaker

- ⑤ PV Breaker 1: Depends on PV system 1
- ⑥ Grid Load Breaker: Depends on Grid Load

# 3. Installation

## 3.8 Parallel Wiring Diagram

Please refer to chapter 4.5.6 to set the PCS to work in parallel.

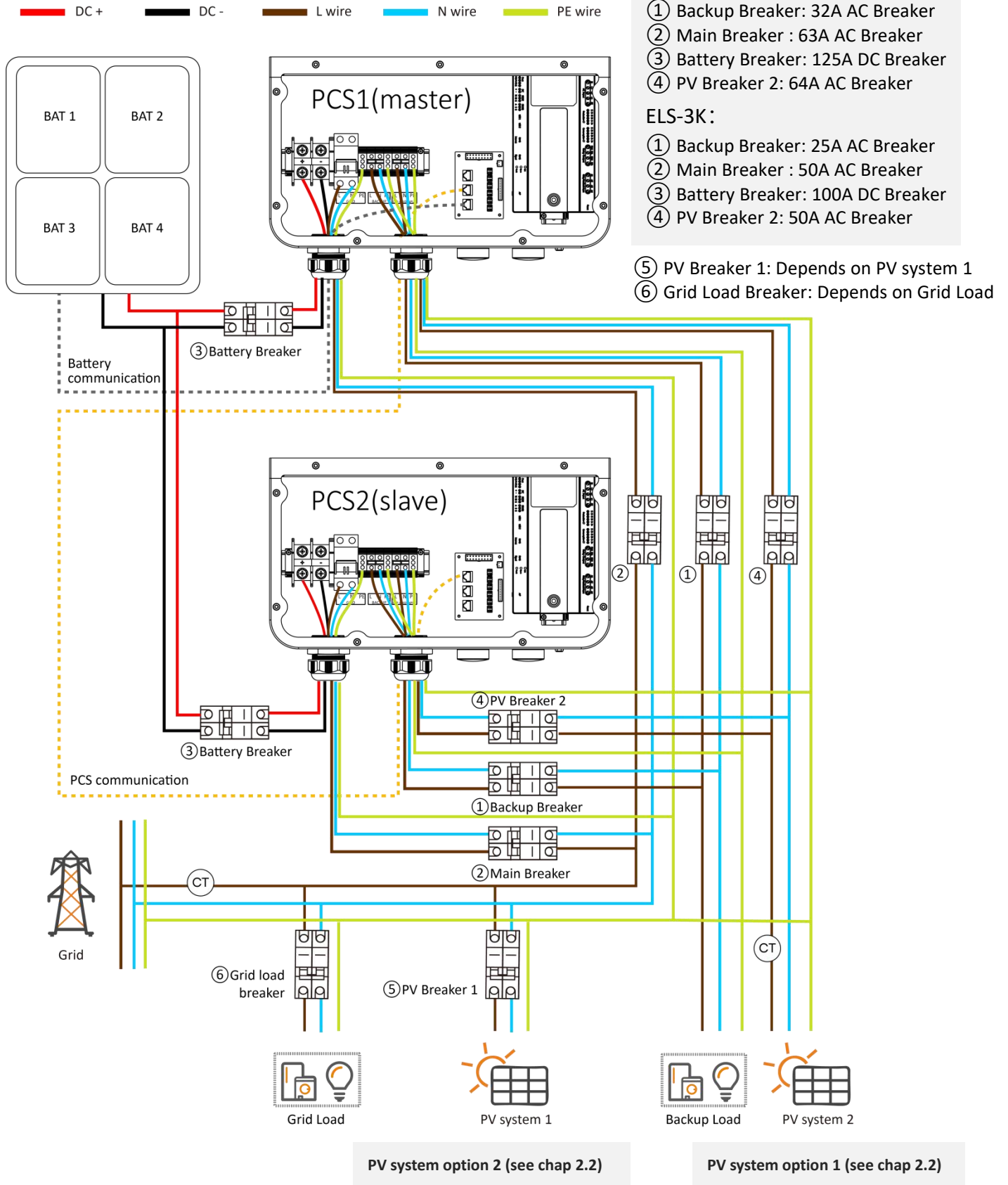

# 3. Installation

## 3.9 PCS Parallel Wiring Steps

**Step 1.** Connect the battery DC cable and the battery communication cable (do not connect the communication cable between PCS and PCS).

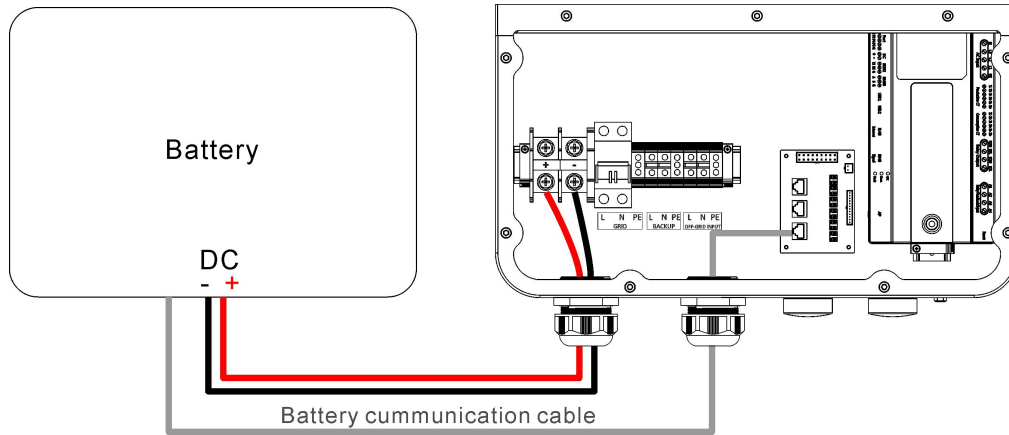

**Step 2.** Use the APP to set one as the master and one as the slave. (Please refer to chapter 4.5.6 to set the PCS to work in parallel)

**Step 3.** Reconnect the communication cable between PCS and PCS.

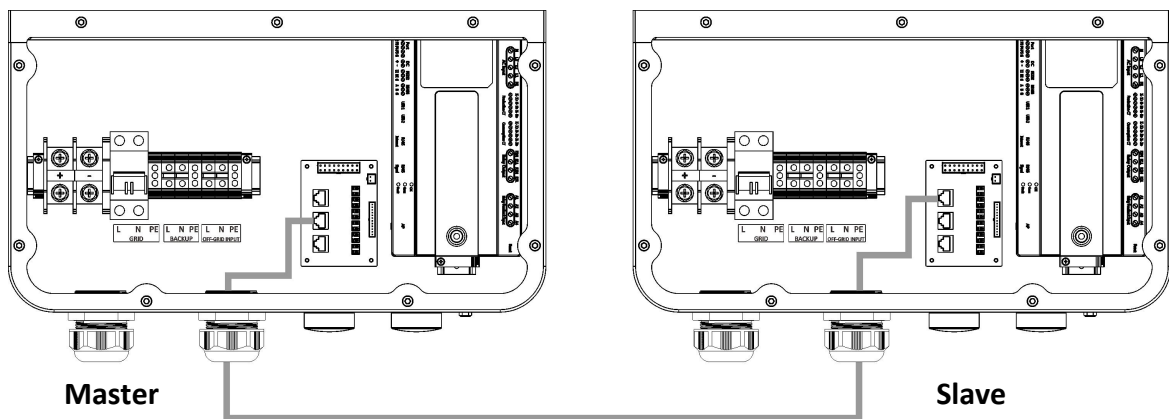

**Step 4.** Use the APP to connect to the host, enter the PCS management interface, and automatically search for 2 PCS IDs, which are the master and the slave.

**Step 5.** Connect all the wires according to the above parallel diagram and use them.



**NOTE:** Please refer the manual of battery to set the batteries work in parallel.

## 3. Installation

### 3.10 Start-up sequence

#### 3.10.1 Power ON

Once the unit has been properly installed and the batteries are connected well, turn on the batteries, then turn on the Battery Breaker, Grid Breaker, Backup Breaker and Main breaker to power the system.

#### 3.10.2 Check the system

Please refer to chapter 4.5.1 to check the system.

#### 3.10.3 Power Off

Turn off the Battery Breaker, Grid Breaker, Backup Breaker and Main breaker to power the system, then turn off the batteries.



**WARNING:** Installation must be performed with care.

Before making the final DC connection or closing DC breaker/disconnect, be sure positive(+) must be connect to positive(+) and negative(-) must be connected to negative(-). Reverse polarity connection on battery will damage the inverter.

---

## 4. APstorage User Interface

Professional and certified Installer can commission, monitor and maintain the APstorage solution and performance via the EMA Manager APP. Please search for the APP in APP Store or Google Play, or use mobile browser to scan the QR codes to download the APP. (EMA App is for end-users, EMA Manager is for installers). You can also click on the link below to download the APP: <http://q-r.to/1OrC>

### 4.1 Configure APstorage with EMA Manager

The APstorage PCS has been designed with local connection and management functionality. You can access this local functionality through EMA Manager.

Click **“Local access”** to enter this function.

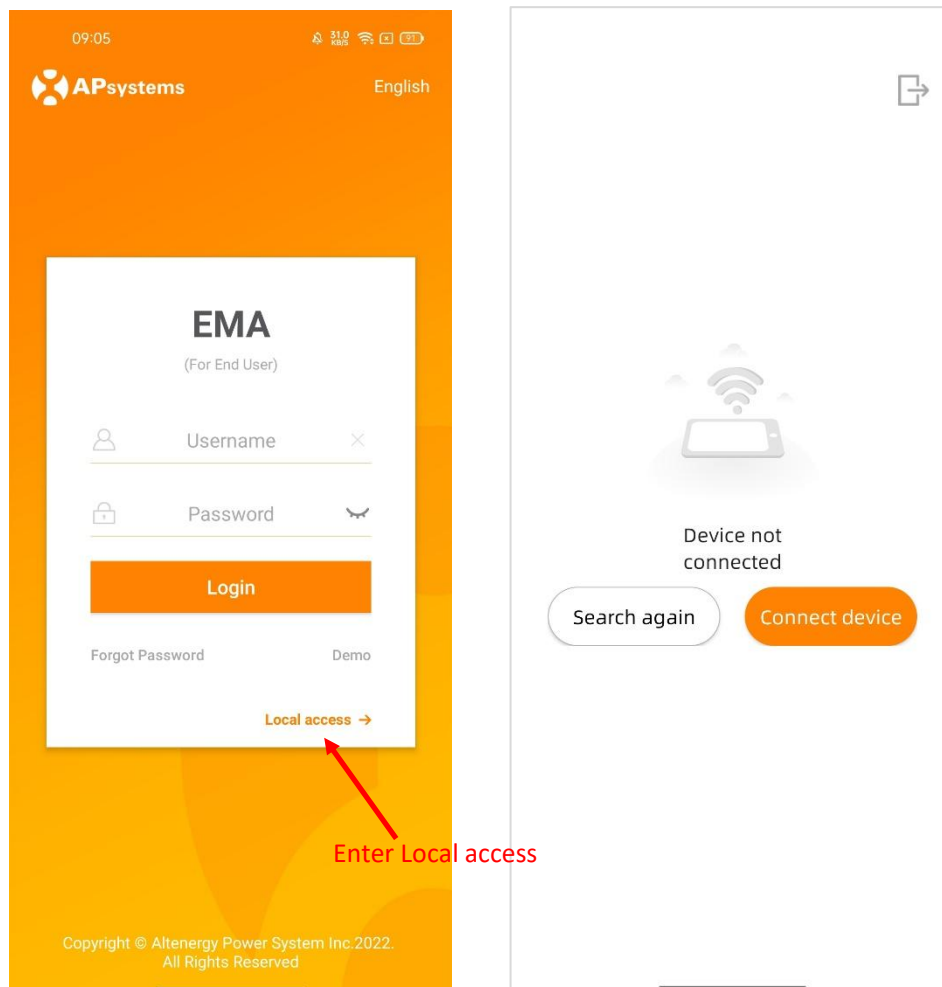

You will be noticed if your smartphone or tablet is not initially connected to the hotspot of the APstorage PCS or the router to which the APstorage PCS is connected.

- Step1: Open Wi-Fi setting in your smartphone, connect to the hotspot of the APstorage PCS, the format of the hotspot is ECU-WIFI\_XXXX, XXXX being the last four digits of the built-in ECU. Also you can connect to the router which the APstorage PCS is connected to.

## 4. APStorage User Interface

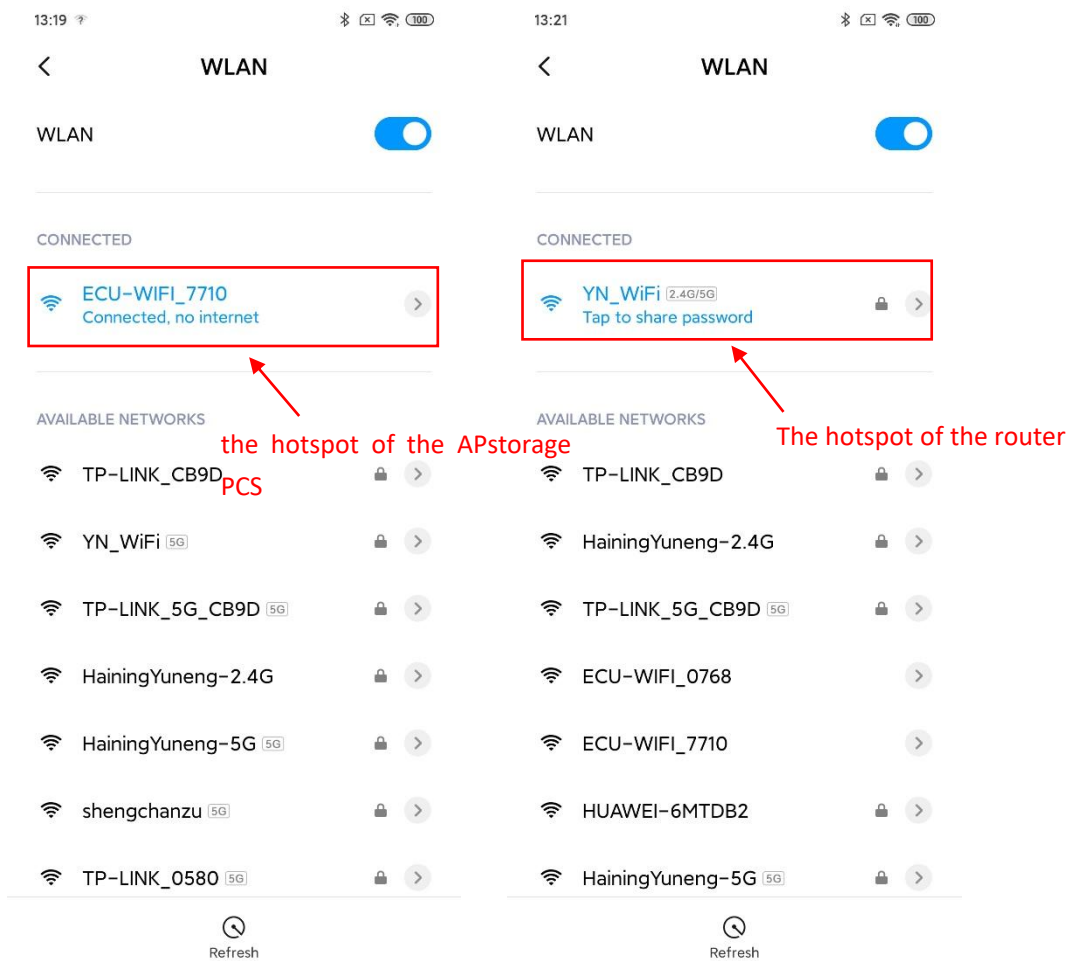

- Step 2: Open EMA Manager.
- Step 3: Click "**Local access**"

You can use this APP to connect the APStorage PCS to the router via Lan or Wlan. (Please refer to chapter 4.5.3)

# 4. APstorage User Interface

## 4.2 Home Page

4.2.1 Once connected to the integrated ECU hot-spot, you can enter the homepage. If there is also an APsystems PV system with an ECU (ECU-R or ECU-C) you can switch ECUs in the LAN by clicking the drop-down box. It can be switched only when the mobile phone and ECU are connected to the same router.

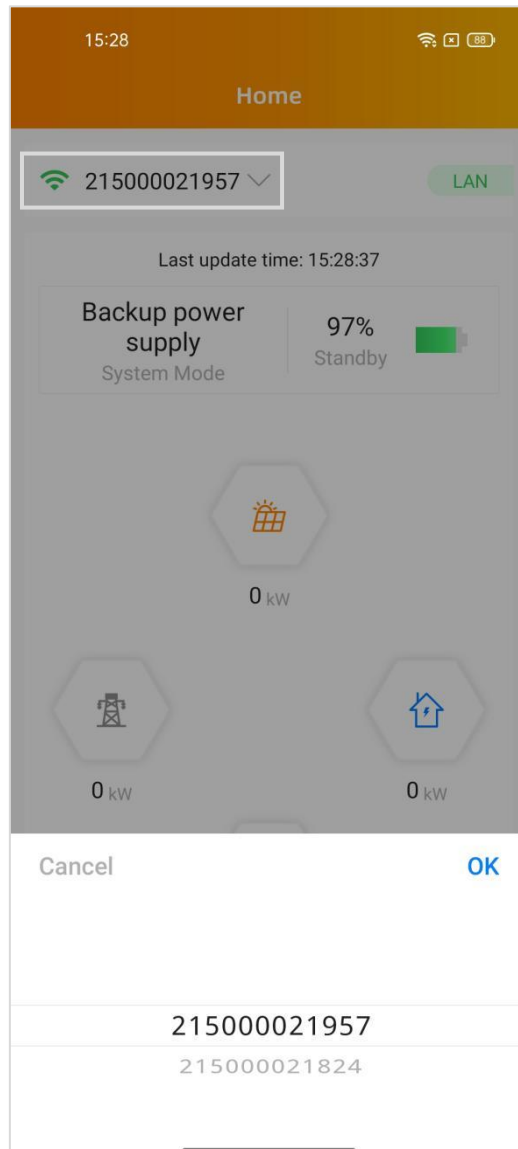



# 4. APstorage User Interface

4.2.2 You can view the system ID, charge and discharge status, real-time power, SOC, today's charged energy, total charged energy since installed, and CO<sub>2</sub> reduction.

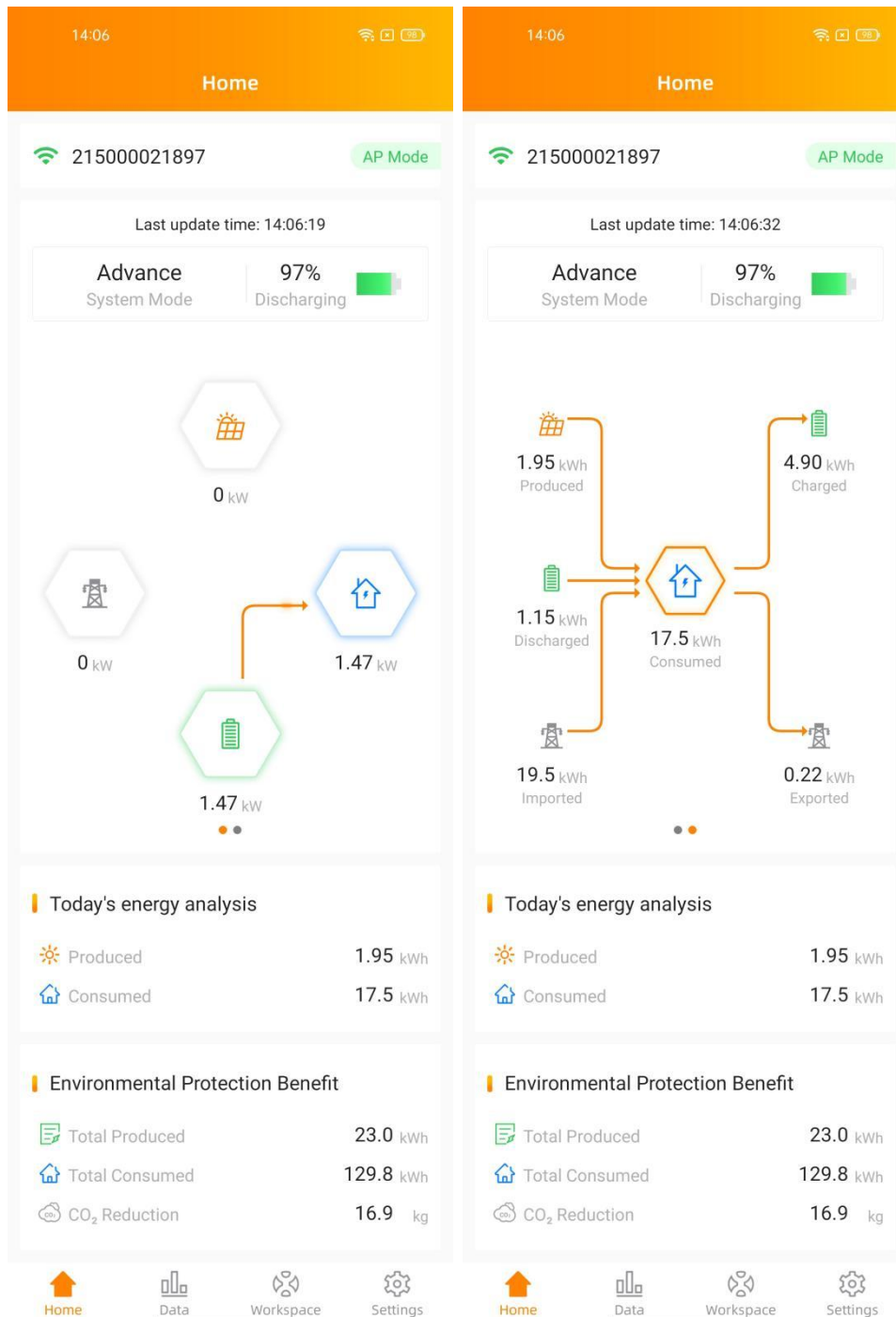

## 4. APstorage User Interface

### 4.3 Module

This page displays the real-time power of the photovoltaic inverter.

Click on the Module, the detailed information of the microinverter will be displayed, including the microinverter ID, PV module power, grid voltage, frequency and temperature.

You need to install APsystems microinverters with the PV modules to view these data.

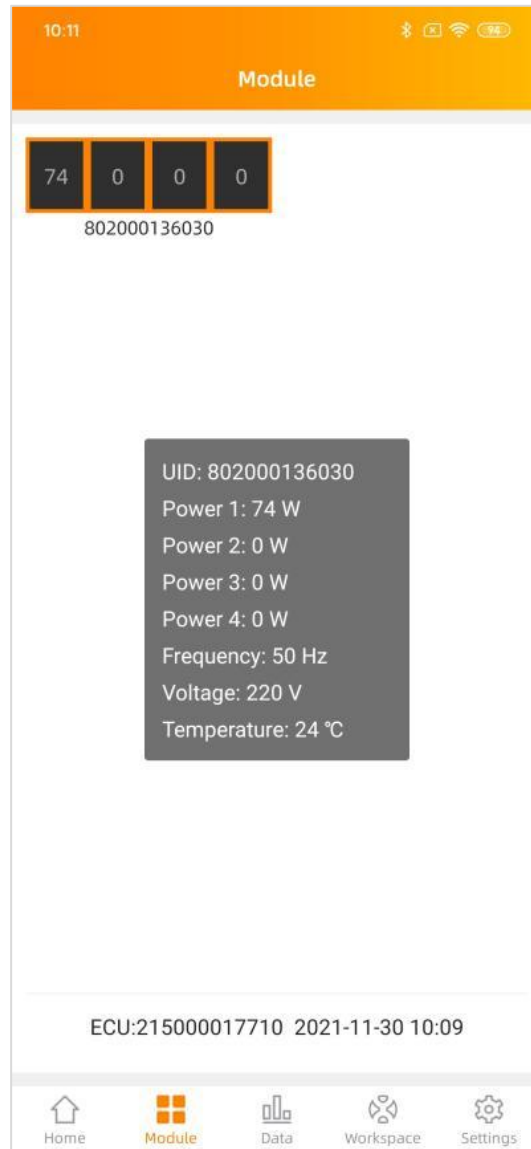

# 4. APStorage User Interface

## 4.4 Data

### 4.4.1 Data overview

This page is used to display the system overview. Select a date to view the system's power summary information and power distribution information and its graph.

Click on the "Energy" or "Power" buttons to view the energy and power chart of the system for the day.

Select Daily, Monthly or Yearly to display the current month, current year, and historical data.

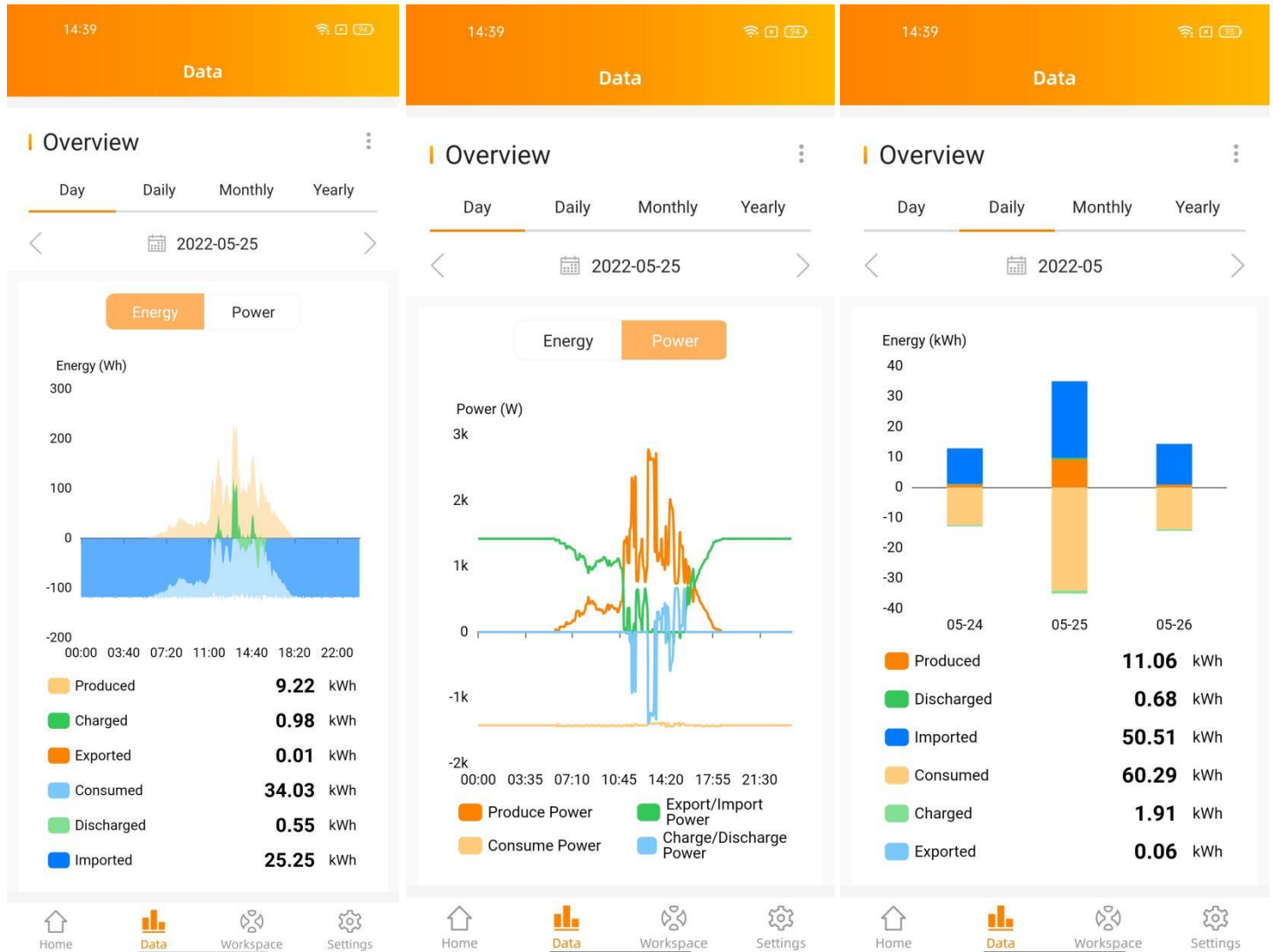

# 4. APStorage User Interface

## 4.4.2 Storage data

The daily energy storage power curve is displayed on this page. Select a date to view the historical power and electricity curve of energy storage.

Select Daily, Monthly or Yearly to display the current month, current year, and historical data curve.

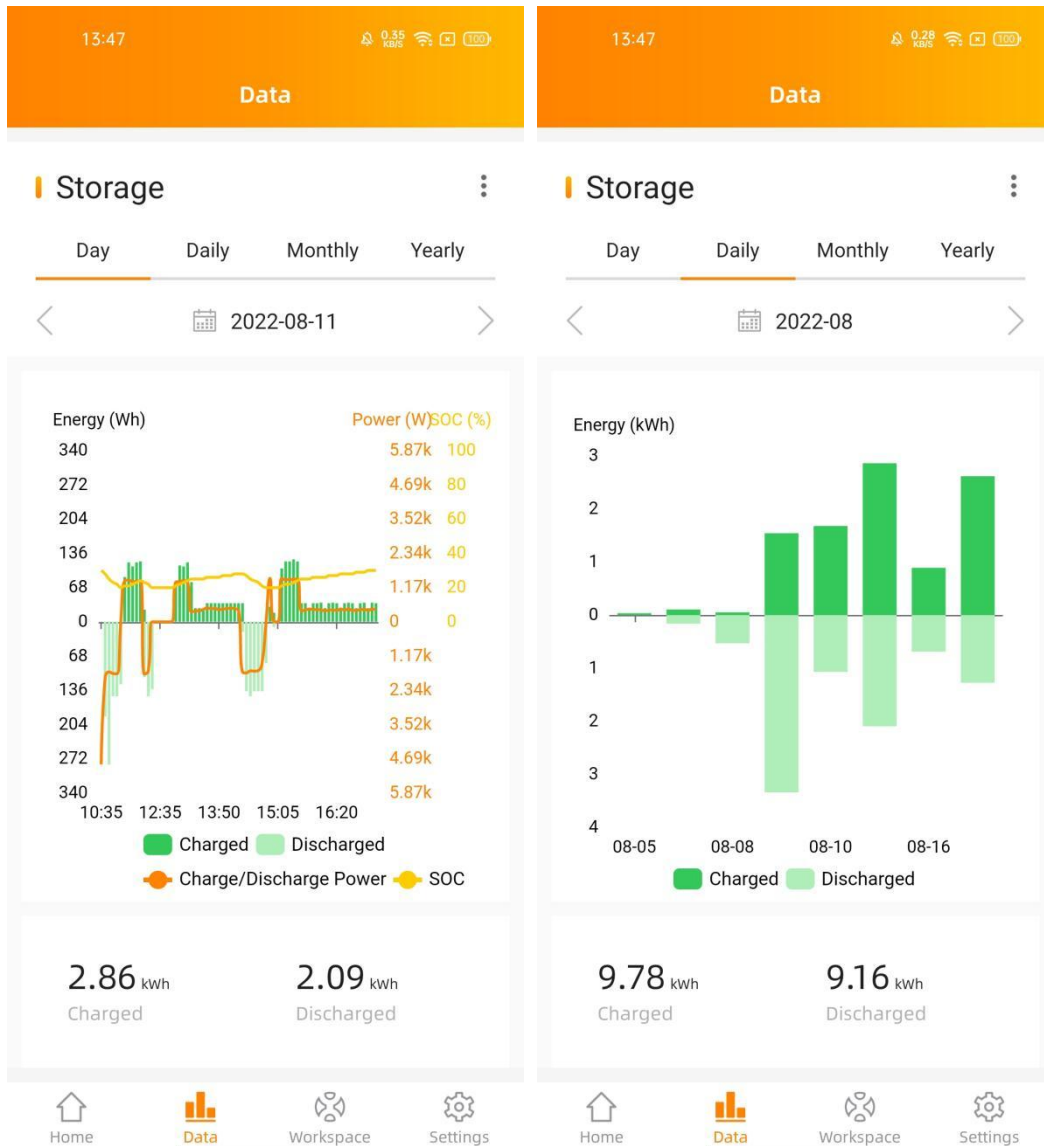

# 4. APstorage User Interface

## 4.4.3 ECU data

The daily photovoltaic power curve is displayed on this page. Select the date to view the PV system data. Select Daily, Monthly or Yearly to display the current month, current year, and historical power curve. You need to install PV system with APsystems microinverters to view these data.

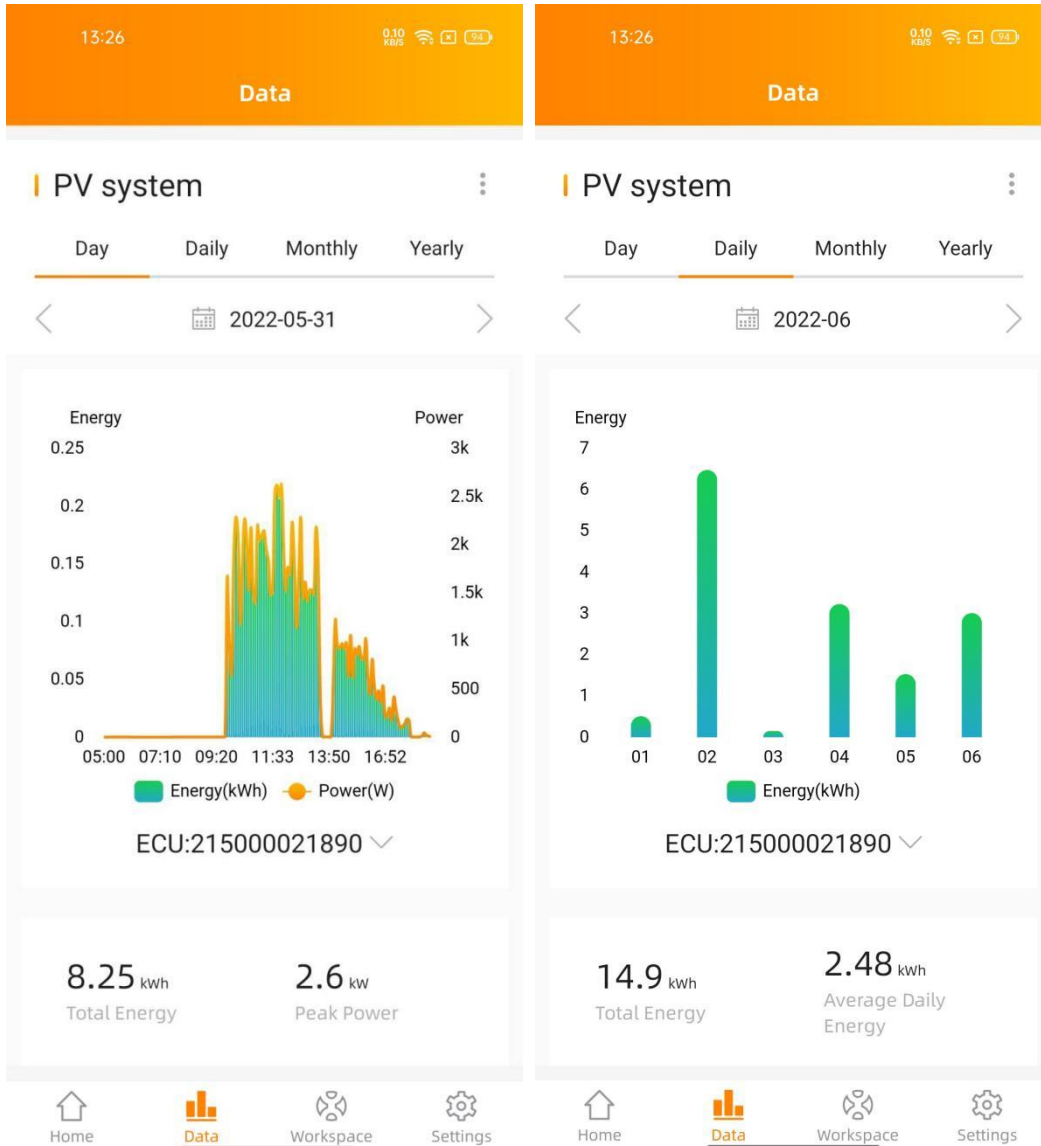

# 4. APstorage User Interface

## 4.5 Workbench

The workbench displays the latest communication time, and currently supported function catalog. Click the corresponding button to enter the function page.

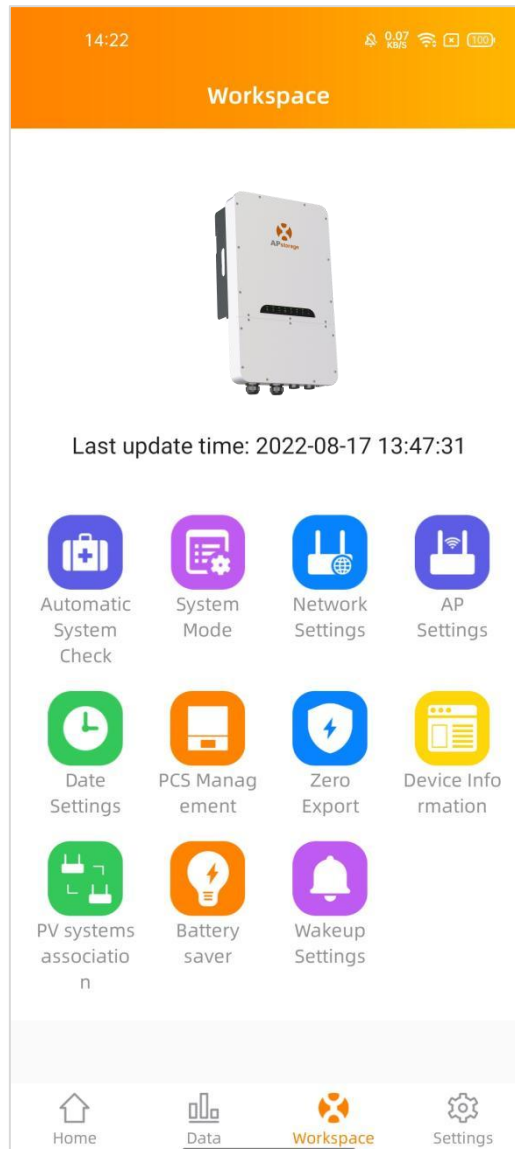

## 4. APstorage User Interface

### 4.5.1 Automatic System Check

Enter the Automatic System Check interface, you can check the APstorage information. If there is an alarm, you can click to view the detailed information.

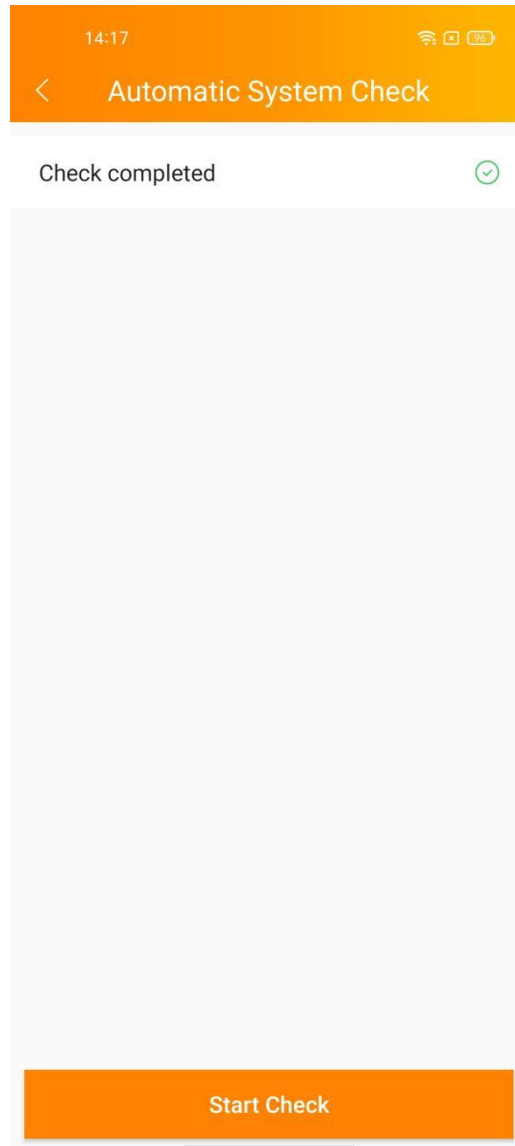

## 4. APstorage User Interface

### 4.5.2 System Mode

The system mode of the APstorage PCS includes Backup power supply mode, residual power Self-Consumption mode and advanced mode. If you need to set the system working mode, please select the corresponding working mode and set the parameters, and then click "OK".

#### Backup power supply mode:

Emergency power supply (EPS) mode, the system charge when grid connected and discharge when off grid.

#### Self-Consumption mode:

APstorage charges when solar power is produced more than home requires, and the power is used for household appliances when your home requires more power than your solar system can provide.

#### Advanced mode:

Discharge during peak time, charge during off-peak time.

#### Peak-Shaving mode:

Input peak-shaving power, when the power of load exceeds the set value of peak-shaving power, the excess power is provided by PCS.

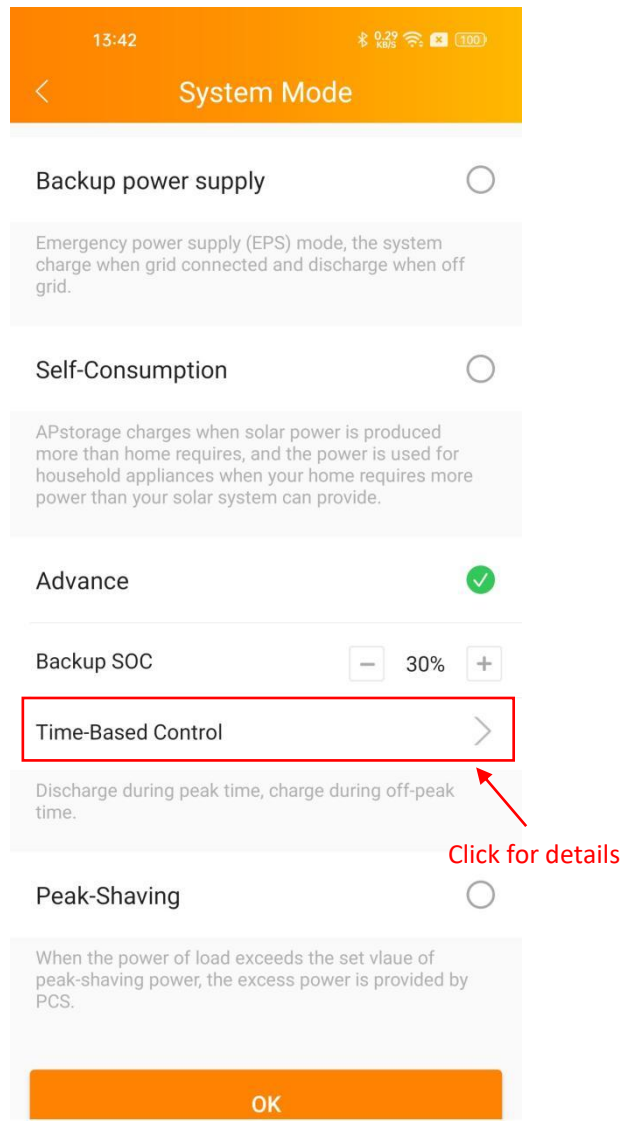



## 4. APstorage User Interface

### 4.5.2.1 Time-Based Control

Click "Time-Based Control", you can view the list of peak times and off-peak times currently set. You can edit the time ranges by clicking on it. Click on the "Add" button to select the peak time or off-peak time to be added.

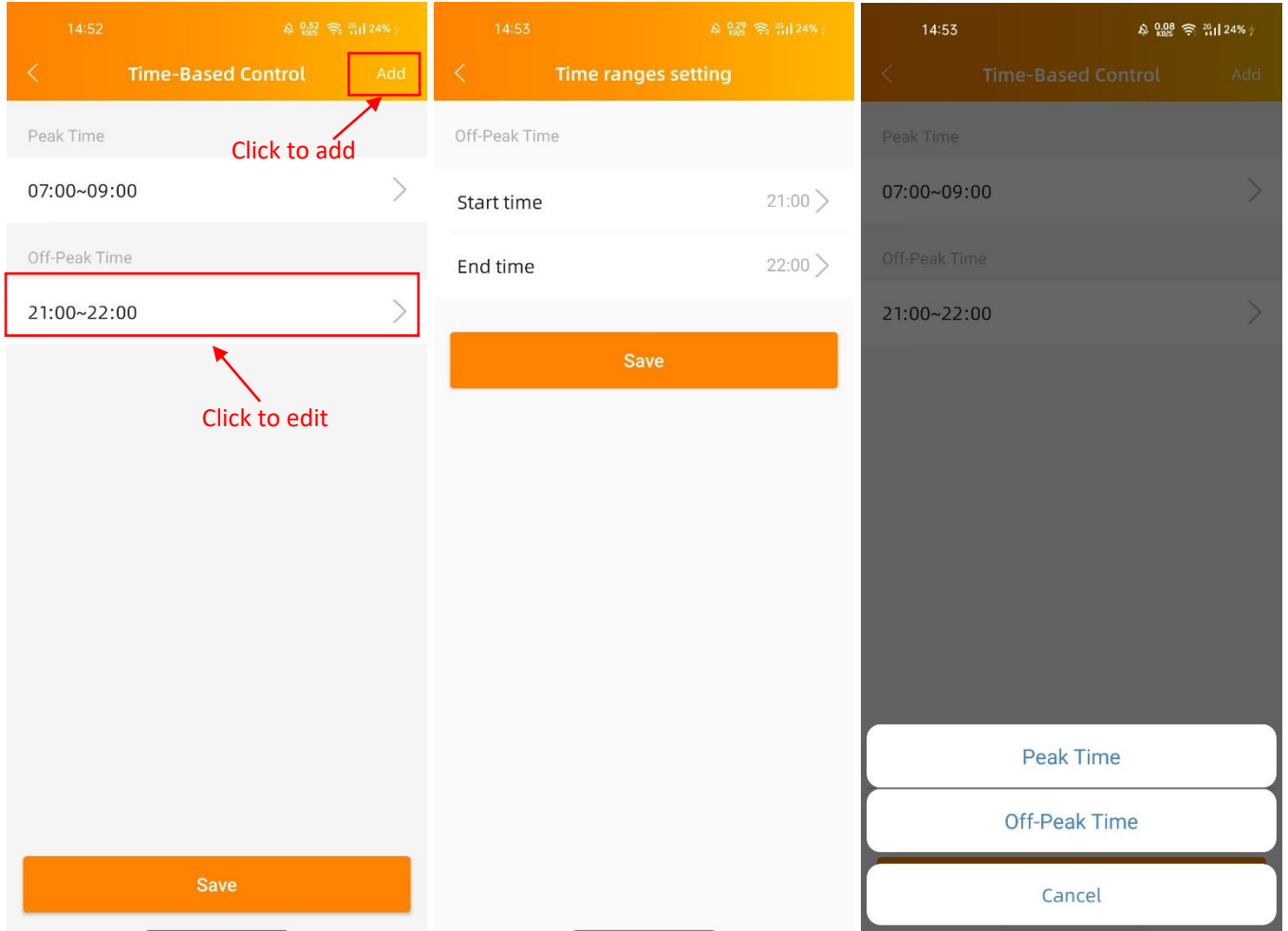

## 4. APstorage User Interface

### 4.5.3 Network Setting

Click the button to enter the WLAN Settings or LAN Settings page.

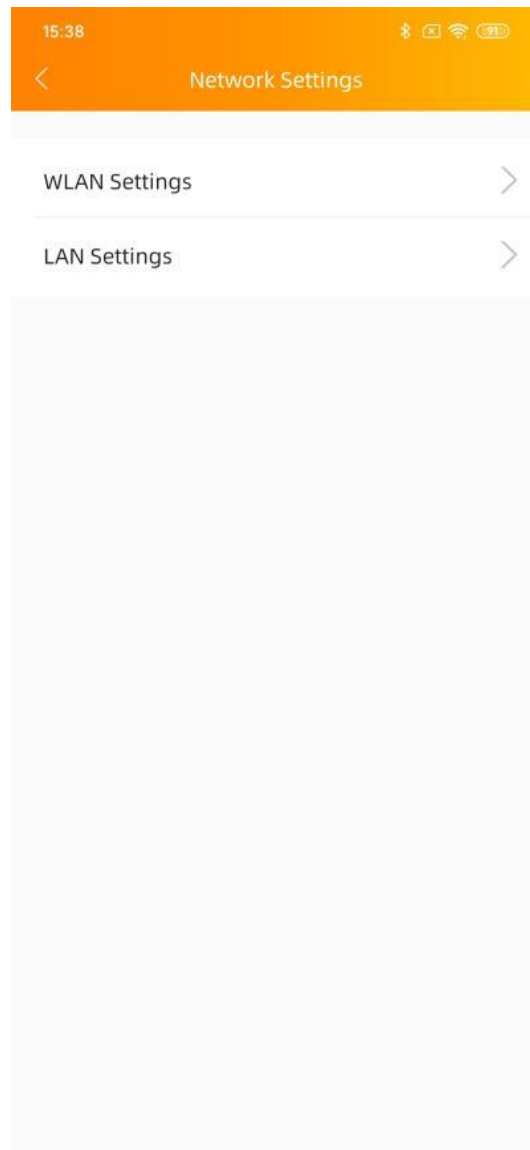

## 4. APstorage User Interface

### 4.5.3.1 WLAN Settings

This interface will display the WLAN connection status of the ECU. Scroll down the screen and the available SSID will be displayed. Click SSID, and enter the password.

After entering the password, the ECU will restart. Please reconnect the ECU.

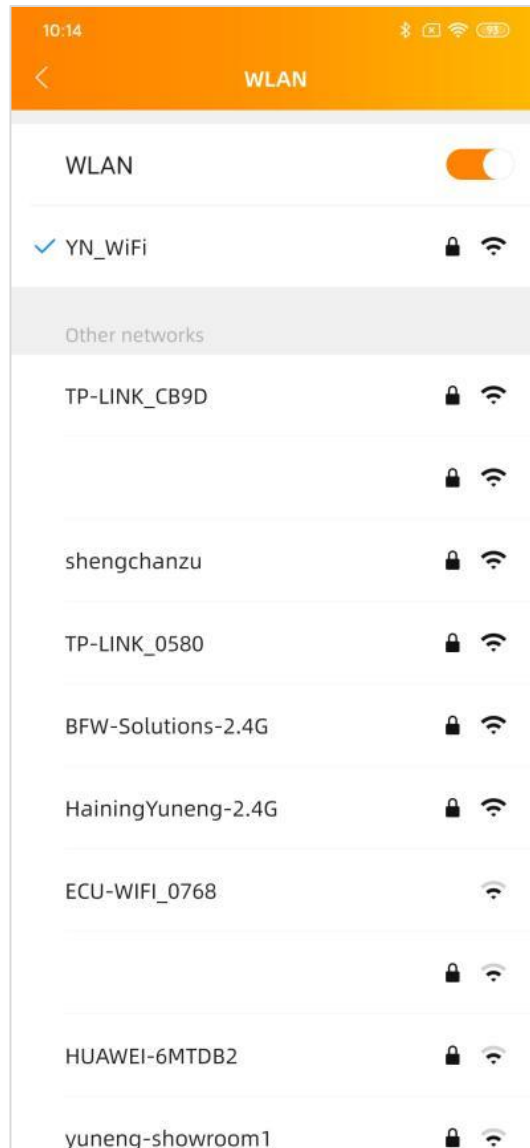

## 4. APstorage User Interface

### 4.5.3.2 LAN Settings

The LAN setting of ECU is divided into automatically obtaining IP address and using fixed IP address.

Obtaining an IP address automatically (recommended) means that the router will automatically assign the IP to the ECU.

When using a fixed IP, please enter the IP address, subnet mask, default gateway, preferred DNS server and alternate DNS server.

The image displays two side-by-side screenshots of the APstorage LAN settings interface. Both screenshots show the time 10:14 and various status icons at the top. The left screenshot shows the 'Obtain an IP address automatically' toggle switch turned on (orange). Below this, the MAC address is listed as 80:97:1B:02:E4:B4 and the IP address is 192.168.131.228. The right screenshot shows the 'Obtain an IP address automatically' toggle switch turned off (grey). Below this, the MAC address is 80:97:1B:02:E4:B4. The IP address field contains 192.168.131.228, the Subnet mask field contains 255.255.255.0, the Default gateway field contains 0, the Preferred DNS server field contains 119.29.29.29, and the Alternate DNS server field contains 182.254.116.116. At the bottom of the right screenshot, there is an orange 'Update' button.

## 4. APstorage User Interface

### 4.5.4 Hotspot Settings

Enter the hotspot setting interface, you can change the hotspot password of the ECU. After setting the password, please reconnect to the hotspot of the ECU.

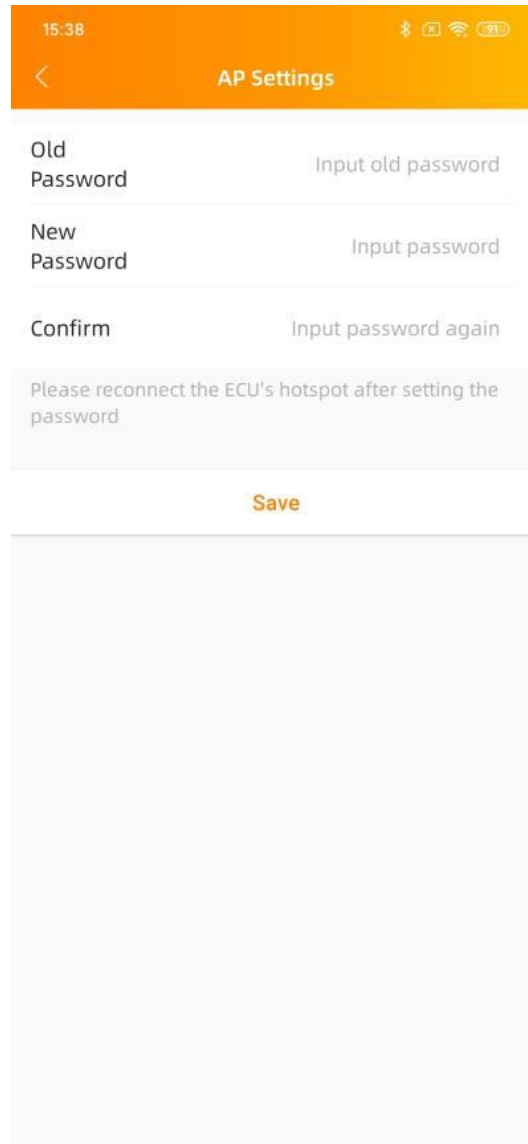

The screenshot shows a mobile application interface titled "AP Settings". At the top, the status bar displays the time "15:38" and icons for Bluetooth, Wi-Fi, and battery. Below the title bar, there are three input fields for password changes:

- Old Password:** Input old password
- New Password:** Input password
- Confirm:** Input password again

Below these fields is a light gray box containing the instruction: "Please reconnect the ECU's hotspot after setting the password". At the bottom of the form is a prominent orange "Save" button.

## 4. APstorage User Interface

### 4.5.5 Data Settings

After entering this page, the time will be displayed on the right. Click on the date, time, and time zone to modify.

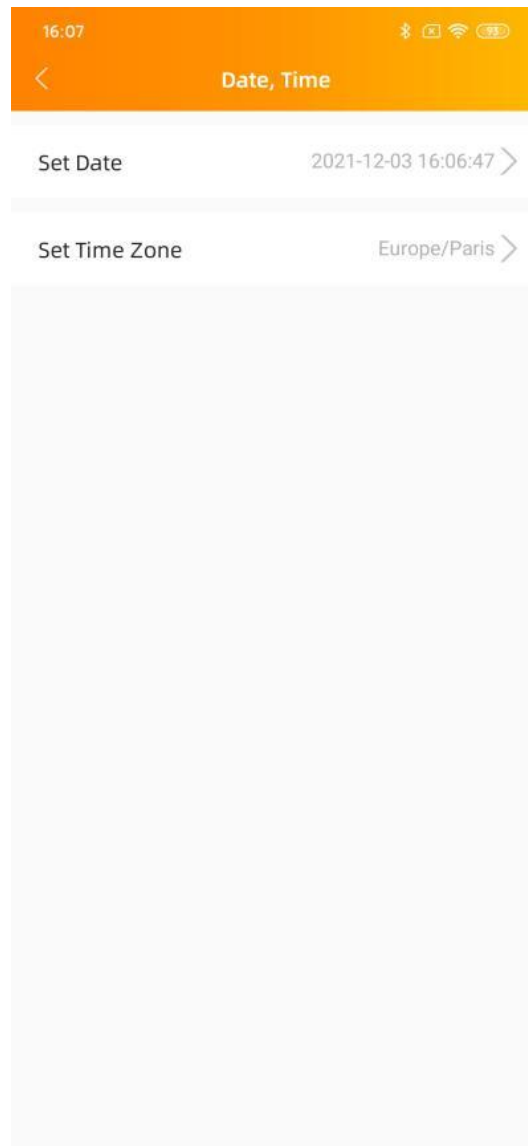

## 4. APstorage User Interface

### 4.5.6 PCS

This page displays a list of PCSs in the system. If the PCS supports the master-slave setting, you can click on “Parallel” to enter the Parallel page.



**NOTE:** Unconfigured PCS, must be set as "Master" or "Slave" to use parallel function.

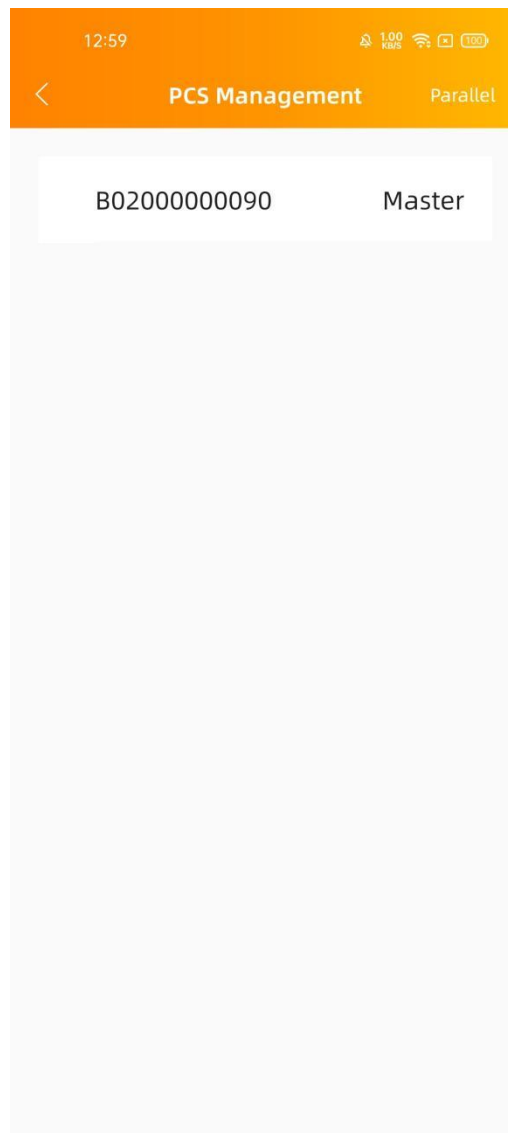

## 4. APstorage User Interface

### 4.5.6.1 PCS Parallel

Select "master" or "slave" and click "save" to complete the setting. After setting, you can see whether PCS is master or slave.



**NOTE:** After the setting is completed, the system will restart, please reconnect the system.

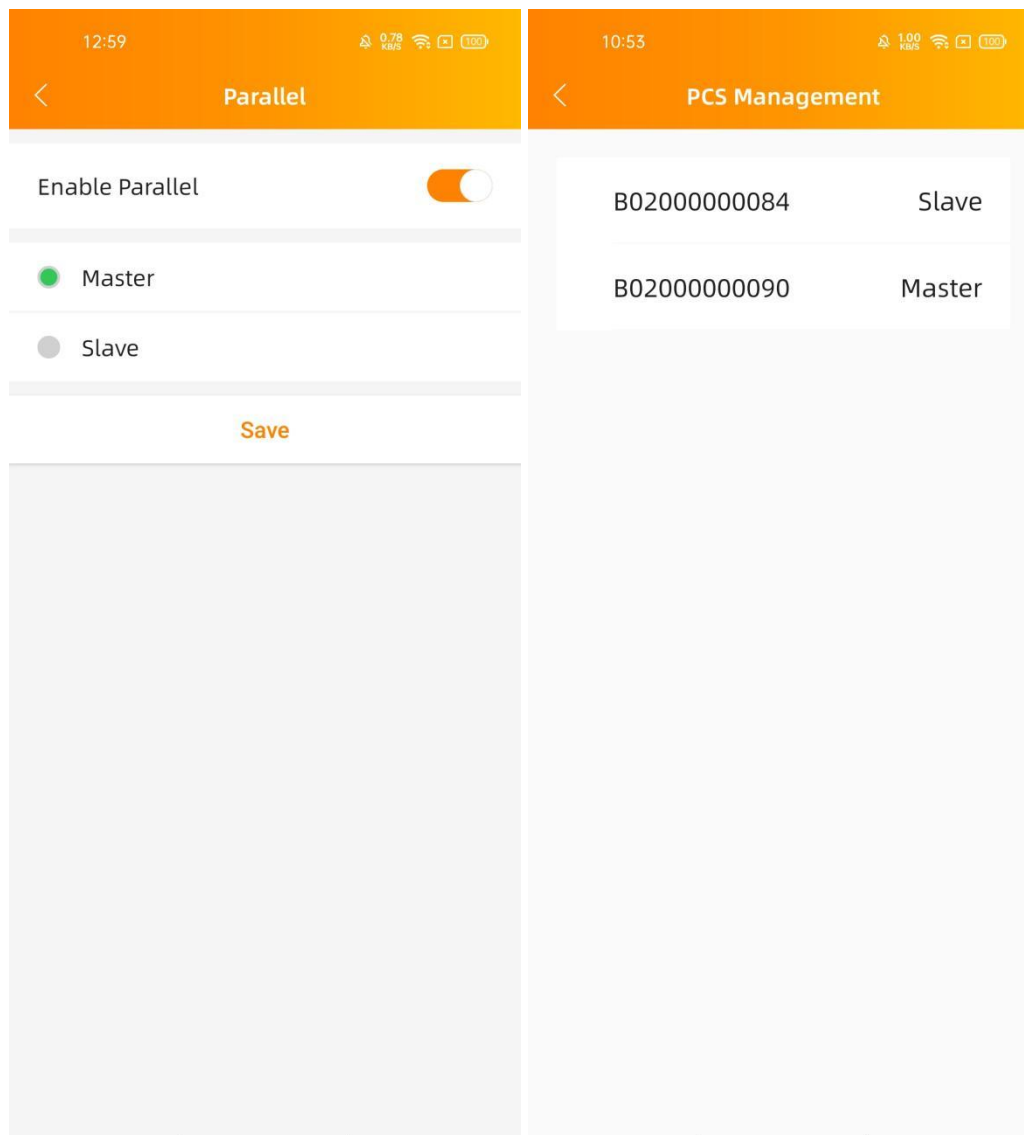



## 4. APstorage User Interface

### 4.5.7 Zero Export

When the APstorage PCS is associated to an APsystems PV system, if needed, the Zero Export function can limit the PV output power to the grid, and the user can set the maximum allowable reverse current power when the Zero Export function is turned on.



**NOTE:** The minimum reverse current power power is set to 0.1KW.

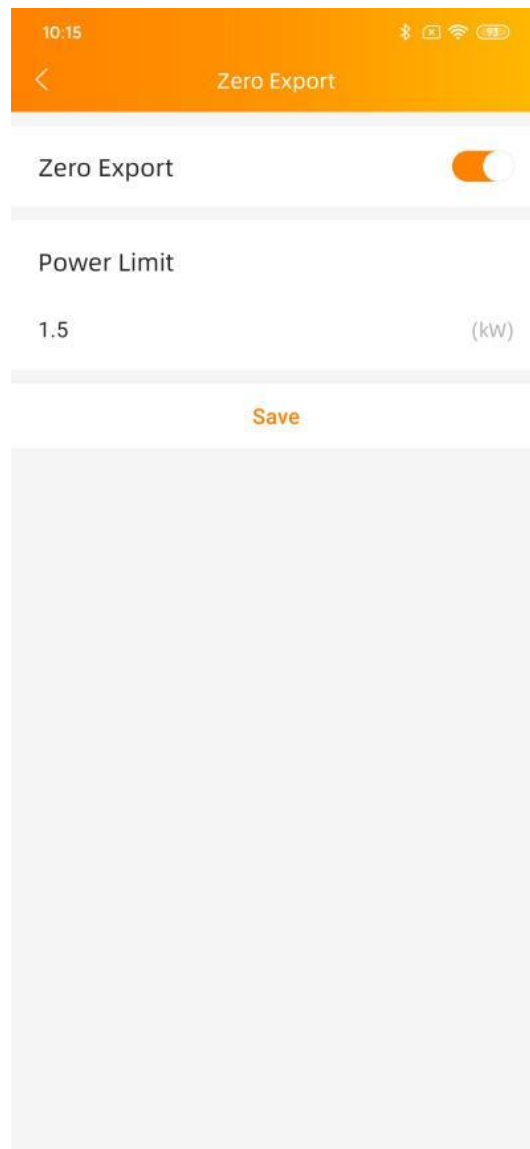

## 4. APstorage User Interface

### 4.5.8 Device Information

The device information page displays the device ID, device type, PCS number, battery capacity, device version number, wired and wireless network MAC, currently connected router SSID, IP address.

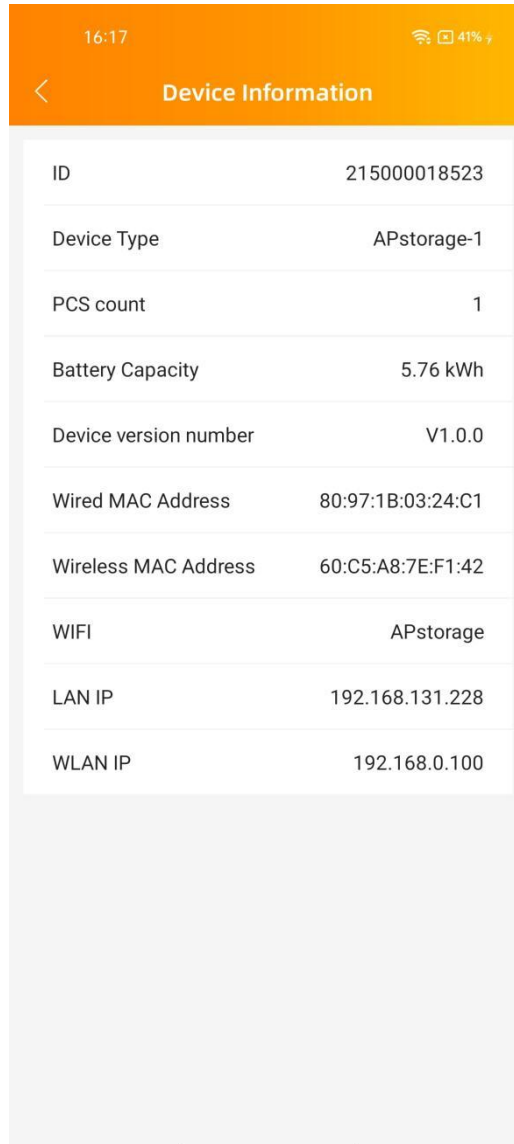

Device Information	
ID	215000018523
Device Type	APstorage-1
PCS count	1
Battery Capacity	5.76 kWh
Device version number	V1.0.0
Wired MAC Address	80:97:1B:03:24:C1
Wireless MAC Address	60:C5:A8:7E:F1:42
WIFI	APstorage
LAN IP	192.168.131.228
WLAN IP	192.168.0.100

## 4. APstorage User Interface

### 4.5.9 Pair APstorage with the PV system

Enter this page, you can view the current association status.

If you have installed APsystems microinverters with an ECU, you can pair the APstorage with the PV system. Enter the PV ECU's ID, then click Save, the APstorage will associate with PV system automatically. It is necessary if you want to turn on zero export function.

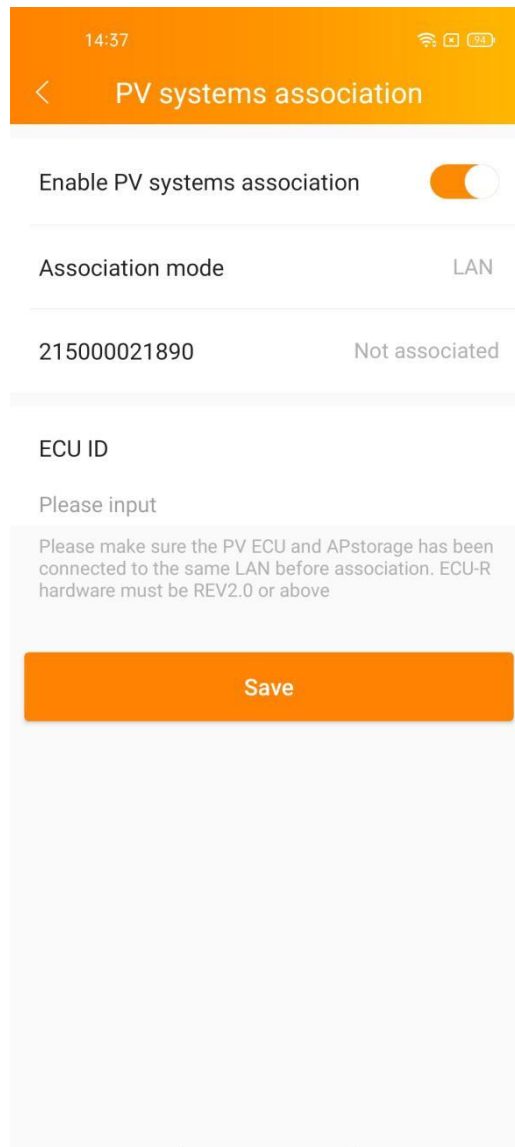

The screenshot shows the 'PV systems association' screen in a mobile application. At the top, the status bar displays the time 14:37 and icons for Wi-Fi, signal strength, and battery. The title bar is orange with a back arrow and the text 'PV systems association'. Below the title bar, there are three rows of settings:

- 'Enable PV systems association' with a toggle switch that is currently turned on (orange).
- 'Association mode' set to 'LAN'.
- A row showing the ECU ID '215000021890' and the status 'Not associated'.

Below these settings is a section for 'ECU ID' with the text 'Please input'. A light gray box contains a warning: 'Please make sure the PV ECU and APstorage has been connected to the same LAN before association. ECU-R hardware must be REV2.0 or above'. At the bottom of this section is a large orange button labeled 'Save'.

## 4. APstorage User Interface

### 4.5.10 Battery saver

Enter this page, you can enable the "battery saver" function. After enabling the "battery saver" function, if APstorage doesn't charge or discharge for an hour, it will go to sleep.

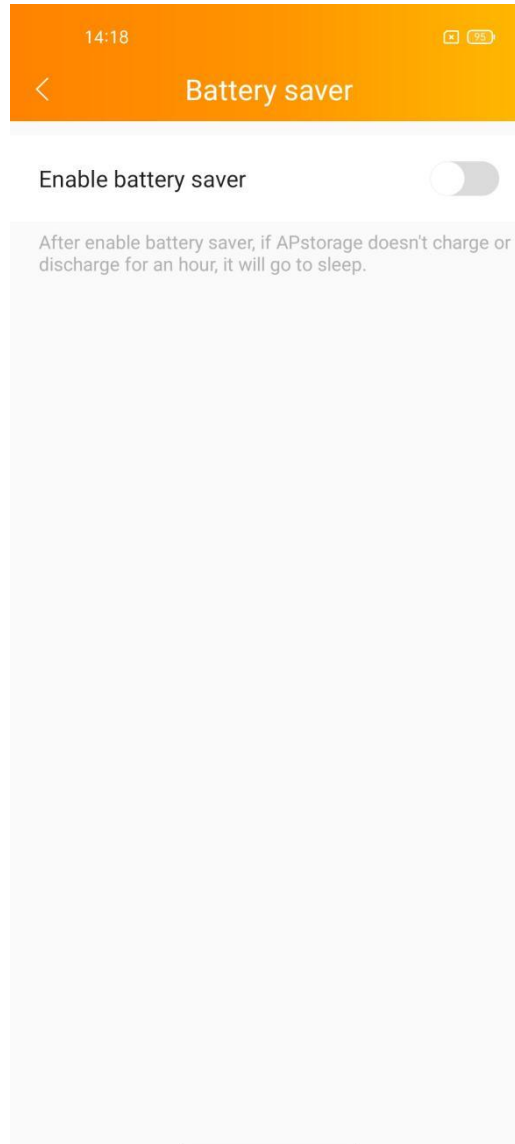

## 4. APstorage User Interface

### 4.5.11 Wakeup Settings

When system enters into sleeping mode, you can wake it up by clicking on "Wake Up Immediately".

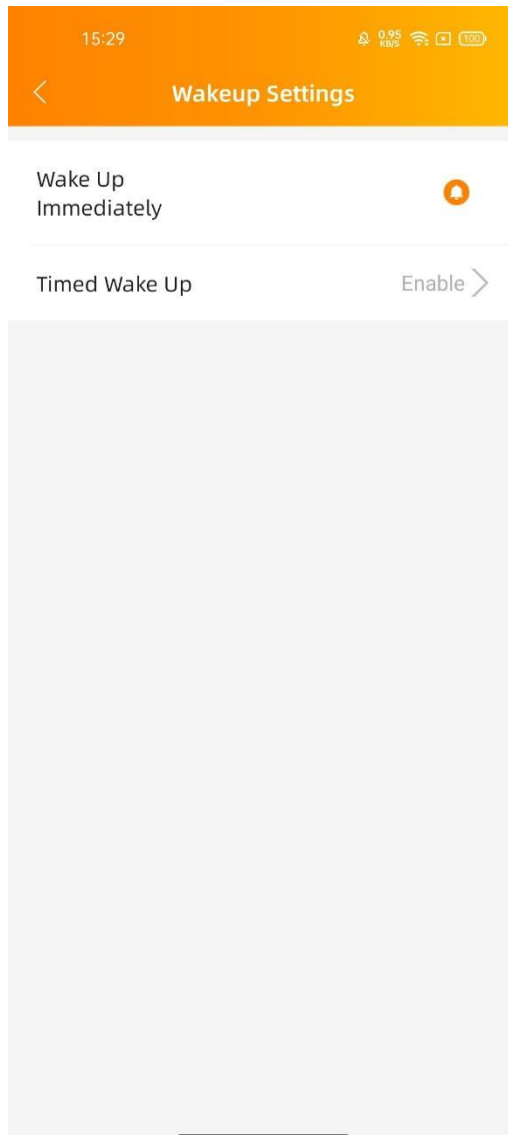

## 4. APStorage User Interface

### 4.5.11.1 Timed Wake Up

On this page, you can set the wake-up time period and interval.

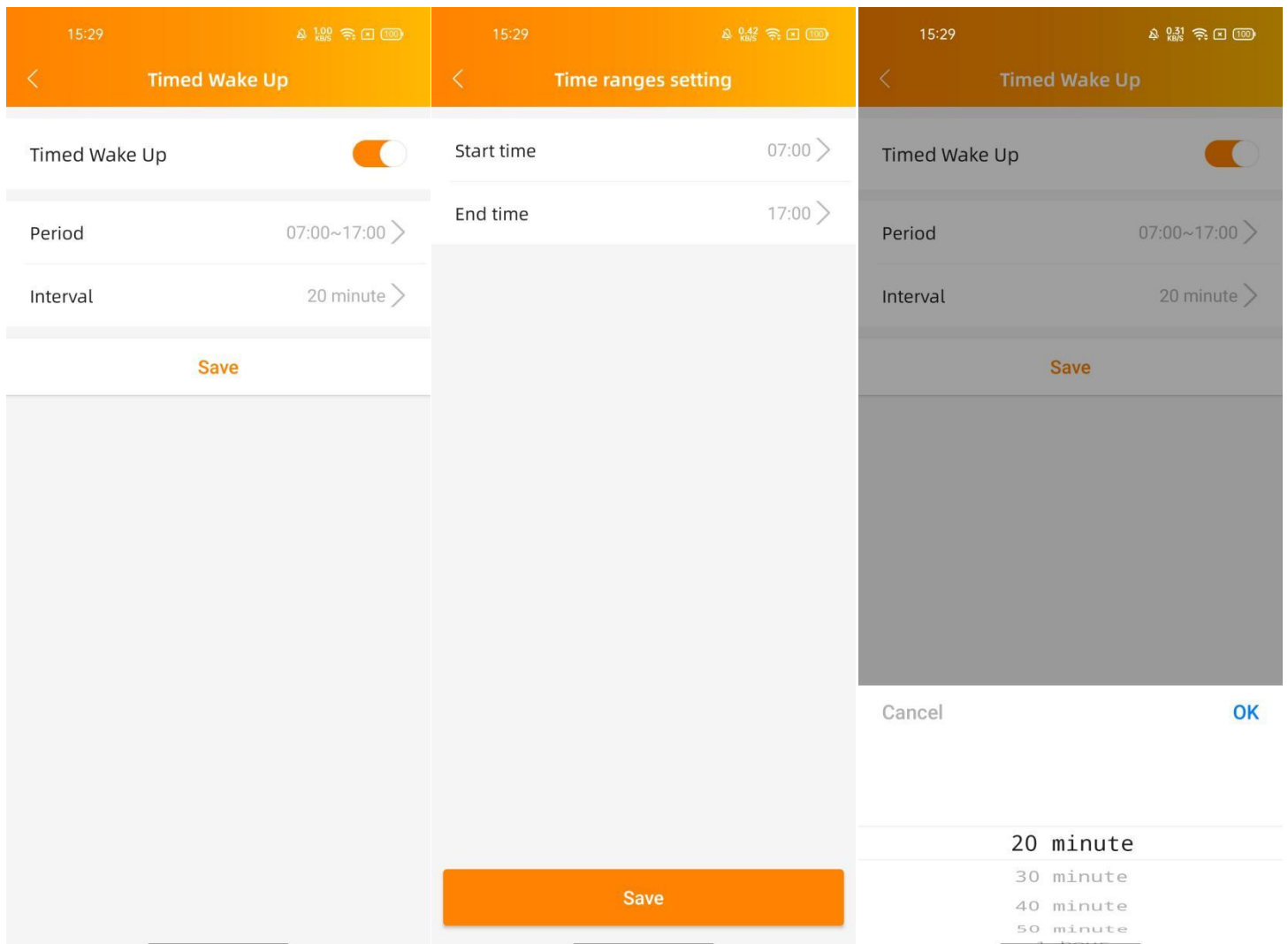

# 4. APstorage User Interface

## 4.6 Settings

Select "Language" to set the APP language, and "About" to view the APP introduction.

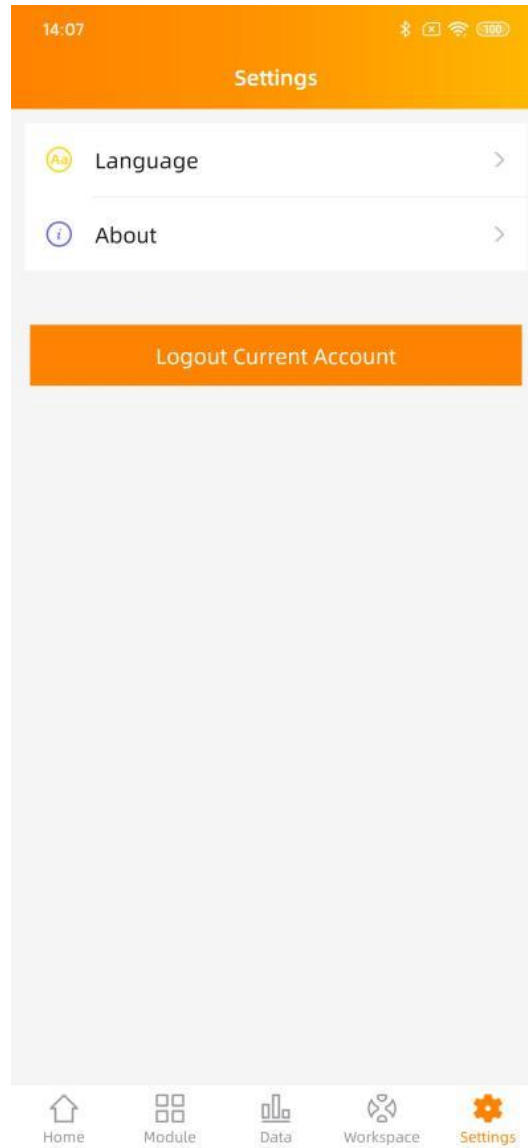

# 5. Technical Data

Model	ELS-5K	EMEAS	ELS-3K
Region		EMEAS	
<b>General Specifications</b>			
Dimensions W/H/D	847×502×197mm		
Weight	29kg		28.7kg
Maximum Efficiency	96.5%		
Temperature Range	-25°C-65°C (-13°F-149°F)		
Ingress Protection	IP65		
Relative Humidity	10%-90%		
Ventilation	Natural convection		
Communication Ports	Ethernet/ Wireless/RS485/CAN		
Zigbee Frequency Range	2405MHz - 2480MHz		
Zigbee Maximum Power	8.94 dBm		
Wi-Fi Frequency Range	2412MHz - 2472MHz		
Wi-Fi Maximum Power	16.97 dBm		
Parallel Function	Yes		
Grid Regulation	VDE-AR-N 4105; TOR Erzeuger; OVE_Richtlinie_R_25; XP C15-712-3; VFR; Din VDE 0126-1-1; Pending: CEI 0-21		
Safety	IEC/EN 62477-1		
EMC	EN 61000-6-1, EN 61000-6-2, EN 61000-6-3, EN 61000-6-4		
<b>Battery Input /Output Data</b>			
DC Battery Input Voltage	40-60VDC		
Battery Capacity	50~800Ah		
Charging Strategy for Li-Ion Battery	Self-adaption to BMS		
Max Continuous Charge Current	100A/96A(DE) <sup>(1)</sup>		77A
Max Continuous Discharge Current	100A/96A(DE) <sup>(1)</sup>		77A
<b>AC Output Data (On-grid)</b>			
Max. Continuous Output Power	5000VA/4600VA(DE) <sup>(1)</sup>		3680VA
Max. Continuous Output Current	21.7A/20A(DE) <sup>(1)</sup>		16A
Max. AC Current From Utility Grid	43.4A/40A(DE) <sup>(1)</sup>		32A
Nominal Output Voltage	230V		
Adjustable Output Voltage Range	184-253V <sup>(2)</sup>		
Nominal Output Frequency/Range	50Hz/47.5-51.5Hz <sup>(2)</sup>		
Output Power Factor	>0.99(Adjustable from 0.8 leading to 0.8 lagging)		
THD	< 3%		
Grid Connection	Single-phase		
<b>AC Output Data (Backup)</b>			
Max. Output Apparent Power	5000VA/4600VA(DE) <sup>(1)</sup>		3680VA
Peak Output Apparent Power	7500VA/6900VA(DE) <sup>(1)</sup> (10s)		5520VA(10s)
Max. Output Current	21.7A/20A(DE) <sup>(1)</sup>		16A
Nominal Output Voltage	230V		
Nominal Output Frequency	50Hz		

(1) The value is for VDE-AR-N 4105

(2) Voltage/frequency range can be adjusted if required by local utility

© All Rights Reserved

Specifications subject to change without notice please ensure you are using the most recent update found at web : [emea.APsystems.com](http://emea.APsystems.com)



## 6. Contact Information

### European offices

#### APsystems

Karspeldreef 8, 1101 CJ, Amsterdam, The Netherlands

Email: [info.emea@APsystems.com](mailto:info.emea@APsystems.com)

Web: [emea.APsystems.com](http://emea.APsystems.com)

#### APsystems

22 Avenue Lionel Terray 69330 Jonage, France

Mail: [info.emea@APsystems.com](mailto:info.emea@APsystems.com)

Web: [emea.APsystems.com](http://emea.APsystems.com)