

1. Packing List

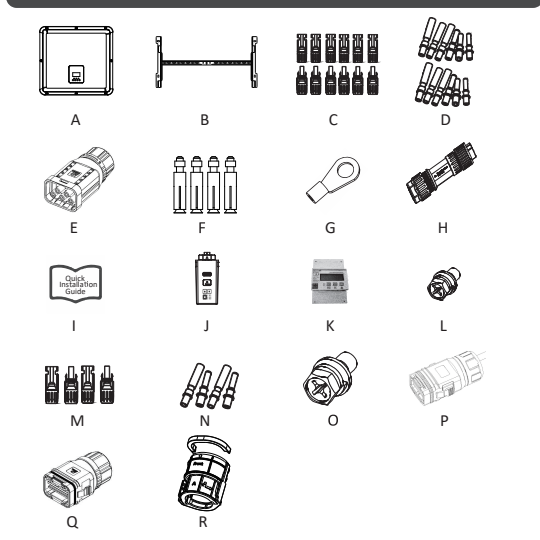

Table with 2 columns: Object, Quantity, Description. Lists items A through R and their specifications.

2. Installation Steps

Please make sure the inverter will be installed with a proper distance as shown below.

Step1: Choose the right location

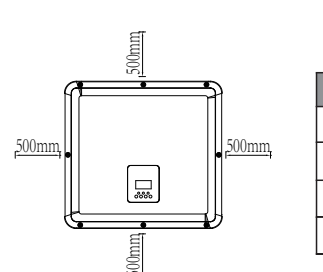
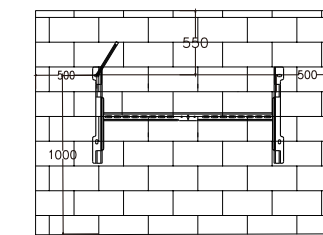

Table with 2 columns: Position, Min Distance. Lists requirements for Left, Right, Top, and Bottom clearance (500mm).

Step2: Mark the position

Installation position recommendation. Use a spirit level to adjust the installation position.



Arrow pointing up.

Step3: Drill the 6 holes with a phi8 drill bit.

Depth: at least 50mm Hammer the expansion tubes

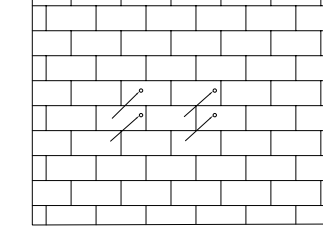

Installing the Bracket Screw the expansion bolts

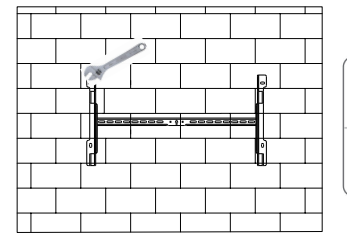
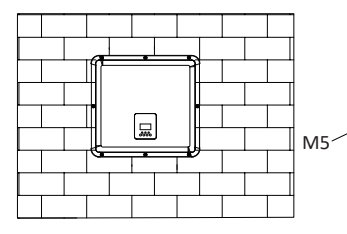

Table with 2 columns: Position, Min Distance. Lists requirements for Left, Right, Top, and Bottom clearance (500mm).

Step4: Match the inverter with bracket

Lock the screws on the side Make sure the inverter is firmly attached.



3. DC Connection

PV Connection

Choose 4mm² wire to connect the PV Prepare AC wire as shown

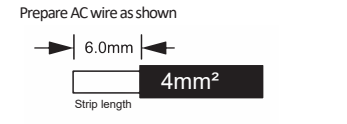

PV-uses such terminals

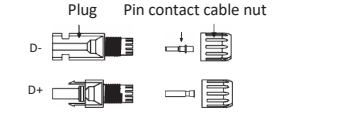

BAT Connection

Press the wire and terminal tightly with a wire clamp

Insert pin into the male or female plug.

Until hear a "click"

Tighten the nut on the terminal

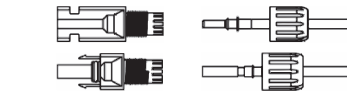

BAT Connection

BAT cable is in the BMS package and is recommended.

Connect the BAT of the inverter and the battery port of the BMS with a power cable.

Communication with BMS, BMS communication line needs to be shorter than 10m Assemble the gland and screw the nut.

Min. operating voltage of the BAT is 120V.

Unlock the DC connector:

- Use the specified wrench tool.

- When separating the DC+ connector, push the tool down from the top.

- When separating the DC- connector, push the tool down from the bottom.

- Separate the connectors by hand.

Battery Wiring

Turn off the DC switch.

Choose 10mm² wire to connect the battery.

Trim 6mm of insulation from the wire end.

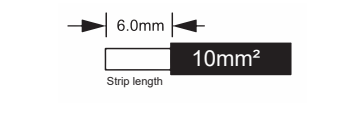

Separate the DC connector (battery) as below.

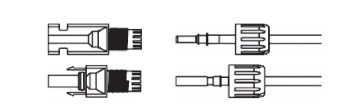
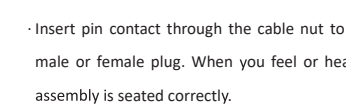
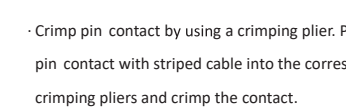
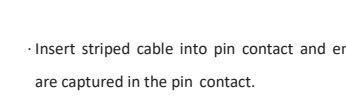
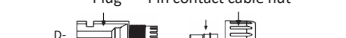

Note:

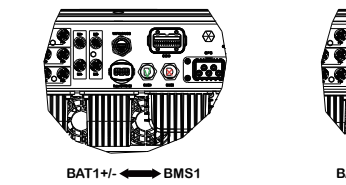

Unlock the DC connector:

- Use the specified wrench tool.

- When separating the DC+ connector, push the tool down from the top.

- When separating the DC- connector, push the tool down from the bottom.

- Separate the connectors by hand.

AC Connection

Step1: Cable dimensions

Table with 2 columns: Modelli (kW), Cable (ON-GRID), Micro-Breaker. Lists specifications for various power models.

Step2: Prepare AC wire as shown in the picture

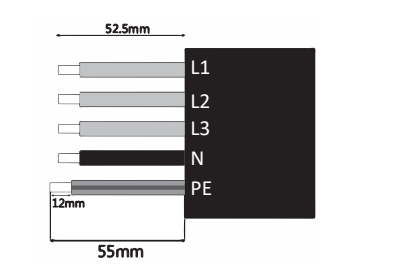

L1/L2/L3: Brown/Red/Green or Yellow Wire

N: Blue/Black Wire

PE: Yellow & Green Wire

Note: Please refer to local cable type and color for actual installation.

A. EPS Connection

- Disassemble the connector

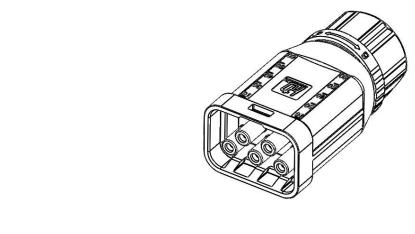

- Tighten the wire with a screwdriver, The torque of the crimp screw is 2.0±0.1N.m. Be sure to disconnect all power supplies before removing the protective end caps and wait 10 minutes before performing maintenance work.

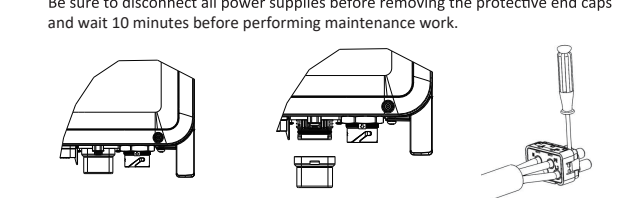

- Put the sealing body and yarn trapper into the main body, screw the lock nut into the main body, and the torque is (2.5 +/- 0.5N.m).

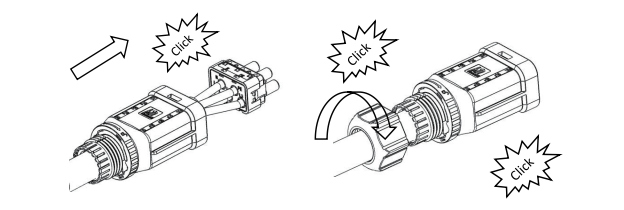

- The female end of the wire is inserted into the male end of the line and accompanied by a click sound, and the installation is complete.

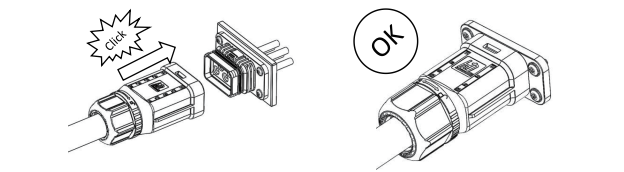

- Use a screwdriver to align the unlock position and press and Hold the thread and pull it back to complete the separation of the male and female.

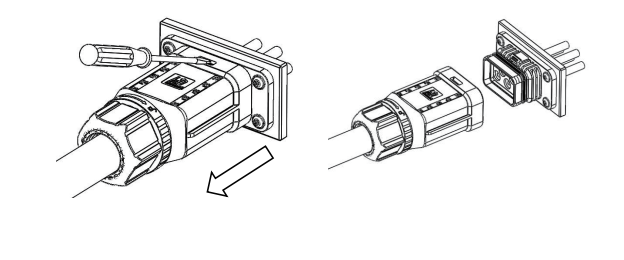

H3 PRO QUICK INSTALLATION GUIDE

B. GRID Wiring

- Separate the ON-GRID plug into three parts as below.

1. Hold the middle part of the female insert, rotate the back shell to loosen it, and detach it from female inset.

2. Remove the cable nut (with rubber insert) from the back shell.

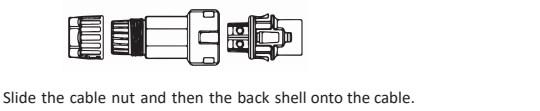

Slide the cable nut and then the back shell onto the cable.



Push the threaded sleeve into the socket, tighten up the cap on the terminal and the torque is (4-5N.m).



Push the threaded sleeve to connection terminal until both are locked tightly on the inverter.

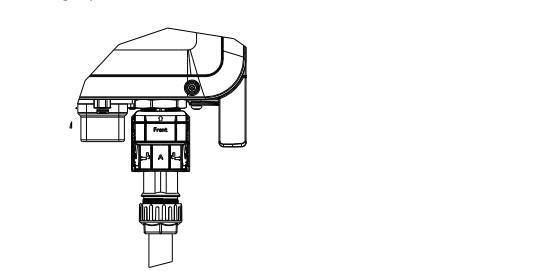

- Remove the GRID connector:Using the matching U-shaped unlocking tool, remove the external mechanical latch, swirl the swirl, and then pull it out.

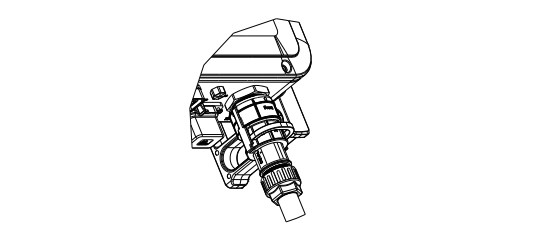

Grounding Wiring

Trim 6mm of insulation from the wire end.



Insert striped cable into earth terminal and ensure all conductor strands are captured in the earth terminal.

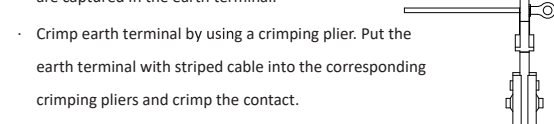

Crimp earth terminal by using a crimping plier. Put the earth terminal with striped cable into the corresponding crimping pliers and crimp the contact.

Use the crimping pliers to press the ground cable into the ground terminal, screw the ground screw with screwdriver as shown below.

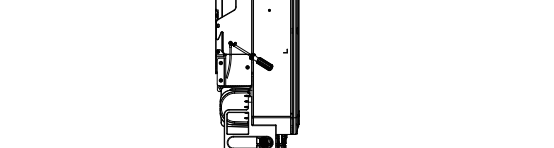

4. Serial Port Connections

Meter and RS485 should be connected to inverter by the connector illustrated in the figure below. All ports in connector should connect to the corresponding ports on inverter.

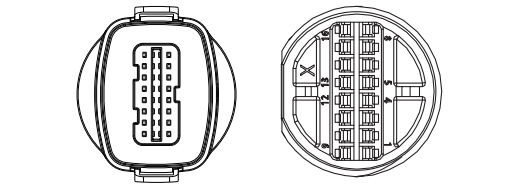

METER/CT/RS485 interface (20pin terminals)

Table with 2 columns: METER/CT/RS485 interface (20pin terminals). Lists pin numbers 1-20 and their corresponding terminal labels.

Note: GND TVS, RY Ctrl, these wiring terminals are tested in the factory, please do not connect them.

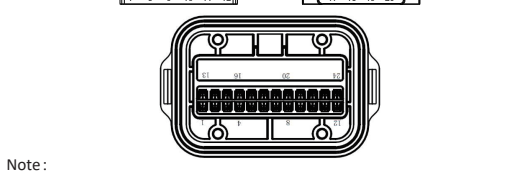
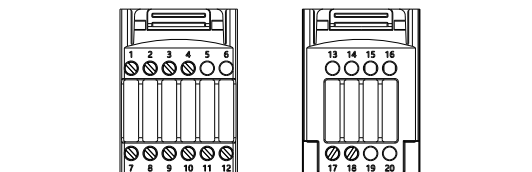

- Pin11 is the power supply+12V, and Pin10 is the corresponding GND used. The maximum load of the 12V power supply port cannot exceed 10W (instantaneous current cannot exceed 1A); Otherwise, it will damage the inverter.

COM interface (24pin terminals)

Table with 2 columns: COM interface (24pin terminals). Lists pin numbers 1-24 and their corresponding terminal labels.

Note: ARM 485A, ARM 485B , GND COM, VCC these wiring terminals are tested in the factory, please do not connect them.

Parallel1 (24pin terminals)

Table with 2 columns: Parallel1 (24pin terminals). Lists pin numbers 1-24 and their corresponding terminal labels.

Parallel2 (24pin terminals)

Table with 2 columns: Parallel2 (24pin terminals). Lists pin numbers 1-24 and their corresponding terminal labels.

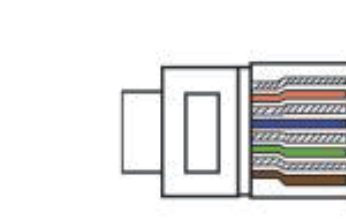
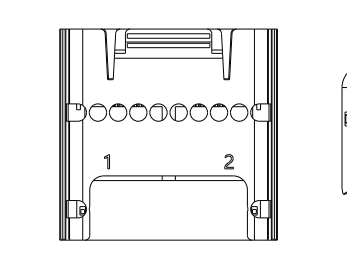
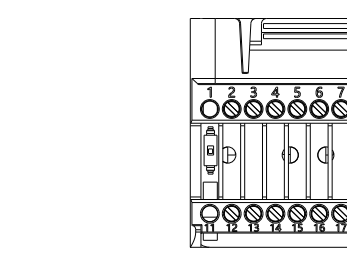

Note:

- Compatible Meter type: DTSU666 (CHINT). For other pin definitions, please refer to the user manual. Communication A and B are marked on the side of the meter;

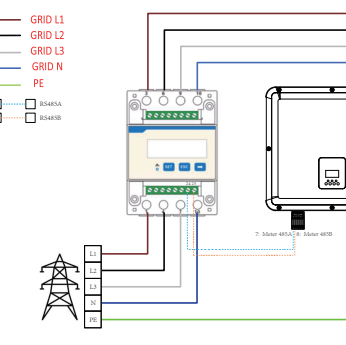

Note: Local wiring colors are based on local codes, the quick release diagrams are for reference only.

5. Inverter Start-Up

Please refer to the following steps to start up the inverter.

- 1. Ensure the inverter fixed well. 2. Make sure all wirings are completed. 3. Make sure the meter is connected well. 4. Make sure the battery is connected well. 5. Make sure the AC-EP5 contactor is connected well (if needed). 6. Make sure the BMS buttons and battery switch are off. 7. Turn on the PV/DC switch (for Hybrid version only), AC-GRID breaker, EPS breaker and battery breaker. 8. If the main page shows "switch off", please long press "v" bottom to quickly go to the START/STOP page and set it to start. (Enter the settings page, default password is '0000').

Note: - Add boot-up guide interface, the first boot-up need to select the safety regulations and set the time. - Set the time on the inverter using the button or by using the APP.

6. Inverter Switch Off

Please refer to the following steps to switch off the inverter.

- 1. Enter the settings page, select START / STOP and set it to stop. 2. Turn off the PV/DC switch (for Hybrid version only), AC breaker, EPS breaker and battery breaker. 3. Wait 5 min before you open the upper lid (if in need of repair).

Note: 1. The inverter installation in complete. For battery installation, please refer to battery quick installation guide.

Please scan the QR Code and follow the steps below to download our latest multi-language User Manual/Quick Installation Guide: Scan the QR Code -> Select your Language -> Choose to download User Manual or Quick Installation Guide -> Download

