

SmartGuard-63A-(S0, AUS0)

User Manual

Issue 02
Date 2023-11-06



Copyright © Huawei Digital Power Technologies Co., Ltd. 2023. All rights reserved.

No part of this document may be reproduced or transmitted in any form or by any means without prior written consent of Huawei Digital Power Technologies Co., Ltd.

Trademarks and Permissions



HUAWEI and other Huawei trademarks are the property of Huawei Technologies Co., Ltd.

All other trademarks and trade names mentioned in this document are the property of their respective holders.

Notice

The purchased products, services and features are stipulated by the contract made between Huawei Digital Power Technologies Co., Ltd. and the customer. All or part of the products, services and features described in this document may not be within the purchase scope or the usage scope. Unless otherwise specified in the contract, all statements, information, and recommendations in this document are provided "AS IS" without warranties, guarantees or representations of any kind, either express or implied. The information in this document is subject to change without notice. Every effort has been made in the preparation of this document to ensure accuracy of the contents, but all statements, information, and recommendations in this document do not constitute a warranty of any kind, express or implied.

Huawei Digital Power Technologies Co., Ltd.

Address: Huawei Digital Power Antuoshan Headquarters
Futian, Shenzhen 518043
People's Republic of China

Website: <https://digitalpower.huawei.com>

About This Document

Purpose

This document describes the SmartGuard-63A-S0 and SmartGuard-63A-AUS0 in terms of safety precautions, product introduction, installation, electrical connections, power-on and commissioning, maintenance, and technical specifications. Read this document carefully before installing and using the SmartGuard.





Intended Audience

The document is intended for:

- Sales engineers
- System engineers
- Technical support engineers

Symbol Conventions

The symbols that may be found in this manual are defined as follows.

Symbol	Description
	Indicates a hazard with a high level of risk which, if not avoided, will result in death or serious injury.
	Indicates a hazard with a medium level of risk which, if not avoided, could result in death or serious injury.
	Indicates a hazard with a low level of risk which, if not avoided, could result in minor or moderate injury.
	Indicates a potentially hazardous situation which, if not avoided, could result in equipment damage, data loss, performance deterioration, or unanticipated results. NOTICE is used to address practices not related to personal injury.

Symbol	Description
 NOTE	Supplements the important information in the main text. NOTE is used to address information not related to personal injury, equipment damage, and environment deterioration.

Change History

Changes between document issues are cumulative. The latest document issue contains all the changes in earlier issues.

Issue 02 (2023-11-06)

- Updated [2.2 Networking](#).
- Updated [6.4.1 Deploying a New Plant](#).

Issue 01 (2023-09-19)

This issue is the first official release.

Contents

About This Document.....	ii
1 Safety Information.....	1
1.1 Personal Safety.....	2
1.2 Electrical Safety.....	4
1.3 Environment Requirements.....	6
1.4 Mechanical Safety.....	8
2 Product Description.....	13
2.1 Model Number Description.....	13
2.2 Networking.....	14
2.3 Appearance.....	19
2.4 Electrical Diagram.....	21
2.5 Working Modes.....	21
2.6 Label Description.....	22
3 Storage Requirements.....	25
4 System Installation.....	26
4.1 Installation Modes.....	26
4.2 Installation Position.....	26
4.2.1 Site Selection Requirements.....	26
4.2.2 Clearance Requirements.....	27
4.2.3 Angle Requirements.....	28
4.3 Preparing Tools.....	28
4.4 Pre-installation Check.....	30
4.5 Moving the SmartGuard.....	30
4.6 Wall Mounting.....	31
4.7 Support Mounting.....	32
5 Electrical Connections.....	35
5.1 Preparing Cables.....	36
5.2 Connecting a PE Cable.....	39
5.3 Opening the Maintenance Compartment.....	40
5.4 Installing the Grid AC Output Power Cable.....	42
5.5 Installing the Inverter AC Input Power Cable.....	43

5.6 Installing the Backup Load Output Power Cable.....	45
5.7 Installing the Non-backup Load Output Power Cable.....	47
5.8 Installing EMMA Signal Cables.....	49
5.9 Installing the SmartGuard Signal Cable.....	52
6 System Commissioning.....	55
6.1 Check Before Power-On.....	55
6.2 Closing the Maintenance Compartment.....	56
6.3 System Power-On.....	57
6.3.1 Powering On the SmartGuard.....	58
6.3.2 Powering On Loads.....	61
6.4 Device Commissioning.....	61
6.4.1 Deploying a New Plant.....	62
6.4.2 Commissioning Functions.....	63
6.4.3 Setting Seamless Handover.....	64
6.4.4 Setting Off-Grid Mode for the Inverter.....	65
6.5 Verifying On/Off-Grid Switchover.....	66
7 System Maintenance.....	68
7.1 System Power-Off.....	68
7.2 Routine Maintenance.....	69
7.3 Troubleshooting.....	70
7.4 Operations on the Bypass Switch of the SmartGuard.....	77
7.5 Replacing the SmartGuard.....	78
8 Technical Specifications.....	80
A Connecting the Inverter on the App.....	82
B Upgrading the Inverter.....	86
C Connecting the EMMA on the App.....	87
D Using Smart Appliances (Owner).....	91
D.1 Commissioning the Charger.....	91
D.2 Smart Switch Commissioning.....	91
E Contact Information.....	94
F Digital Power Customer Service.....	96
G Preconfigured Certificate Disclaimer.....	97
H Acronyms and Abbreviations.....	98

1 Safety Information

Statement

Before transporting, storing, installing, operating, using, and/or maintaining the equipment, read this document, strictly follow the instructions provided herein, and follow all the safety instructions on the equipment and in this document. In this document, "equipment" refers to the products, software, components, spare parts, and/or services related to this document; "the Company" refers to the manufacturer (producer), seller, and/or service provider of the equipment; "you" refers to the entity that transports, stores, installs, operates, uses, and/or maintains the equipment.

The **Danger, Warning, Caution, and Notice** statements described in this document do not cover all the safety precautions. You also need to comply with relevant international, national, or regional standards and industry practices. **The Company shall not be liable for any consequences that may arise due to violations of safety requirements or safety standards concerning the design, production, and usage of the equipment.**

The equipment shall be used in an environment that meets the design specifications. Otherwise, the equipment may be faulty, malfunctioning, or damaged, which is not covered under the warranty. The Company shall not be liable for any property loss, personal injury, or even death caused thereby.

Comply with applicable laws, regulations, standards, and specifications during transportation, storage, installation, operation, use, and maintenance.

Do not perform reverse engineering, decompilation, disassembly, adaptation, implantation, or other derivative operations on the equipment software. Do not study the internal implementation logic of the equipment, obtain the source code of the equipment software, violate intellectual property rights, or disclose any of the performance test results of the equipment software.

The Company shall not be liable for any of the following circumstances or their consequences:

- The equipment is damaged due to force majeure such as earthquakes, floods, volcanic eruptions, debris flows, lightning strikes, fires, wars, armed conflicts, typhoons, hurricanes, tornadoes, and other extreme weather conditions.
- The equipment is operated beyond the conditions specified in this document.

- The equipment is installed or used in environments that do not comply with international, national, or regional standards.
- The equipment is installed or used by unqualified personnel.
- You fail to follow the operation instructions and safety precautions on the product and in the document.
- You remove or modify the product or modify the software code without authorization.
- You or a third party authorized by you cause the equipment damage during transportation.
- The equipment is damaged due to storage conditions that do not meet the requirements specified in the product document.
- You fail to prepare materials and tools that comply with local laws, regulations, and related standards.
- The equipment is damaged due to your or a third party's negligence, intentional breach, gross negligence, or improper operations, or other reasons not related to the Company.

1.1 Personal Safety

 **DANGER**

Ensure that power is off during installation. Do not install or remove a cable with power on. Transient contact between the core of the cable and the conductor will generate electric arcs or sparks, which may cause a fire or personal injury.

 **DANGER**

Non-standard and improper operations on the energized equipment may cause fire, electric shocks, or explosion, resulting in property damage, personal injury, or even death.

 **DANGER**

Before operations, remove conductive objects such as watches, bracelets, bangles, rings, and necklaces to prevent electric shocks.

 **DANGER**

During operations, use dedicated insulated tools to prevent electric shocks or short circuits. The dielectric withstanding voltage level must comply with local laws, regulations, standards, and specifications.

 **WARNING**

During operations, wear personal protective equipment such as protective clothing, insulated shoes, goggles, safety helmets, and insulated gloves.

Figure 1-1 Personal protective equipment

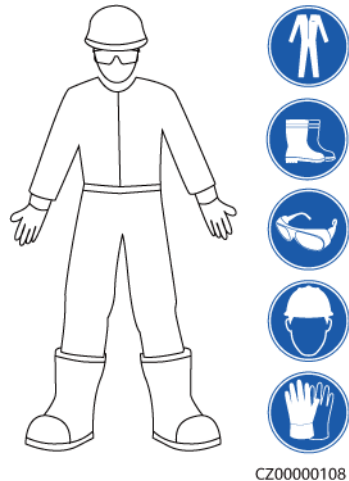

General Requirements

- Do not stop protective devices. Pay attention to the warnings, cautions, and related precautionary measures in this document and on the equipment.
- If there is a likelihood of personal injury or equipment damage during operations, immediately stop, report the case to the supervisor, and take feasible protective measures.
- Do not power on the equipment before it is installed or confirmed by professionals.
- Do not touch the power supply equipment directly or with conductors such as damp objects. Before touching any conductor surface or terminal, measure the voltage at the contact point to ensure that there is no risk of electric shock.
- Do not touch operating equipment because the enclosure is hot.
- Do not touch a running fan with your hands, components, screws, tools, or boards. Otherwise, personal injury or equipment damage may occur.
- In the case of a fire, immediately leave the building or the equipment area and activate the fire alarm or call emergency services. Do not enter the affected building or equipment area under any circumstances.

Personnel Requirements

- Only professionals and trained personnel are allowed to operate the equipment.
 - Professionals: personnel who are familiar with the working principles and structure of the equipment, trained or experienced in equipment operations and are clear of the sources and degree of various potential hazards in equipment installation, operation, maintenance

- Trained personnel: personnel who are trained in technology and safety, have required experience, are aware of possible hazards on themselves in certain operations, and are able to take protective measures to minimize the hazards on themselves and other people
- Personnel who plan to install or maintain the equipment must receive adequate training, be able to correctly perform all operations, and understand all necessary safety precautions and local relevant standards.
- Only qualified professionals or trained personnel are allowed to install, operate, and maintain the equipment.
- Only qualified professionals are allowed to remove safety facilities and inspect the equipment.
- Personnel who will perform special tasks such as electrical operations, working at heights, and operations of special equipment must possess the required local qualifications.
- Only authorized professionals are allowed to replace the equipment or components (including software).
- Only personnel who need to work on the equipment are allowed to access the equipment.

1.2 Electrical Safety

 **DANGER**

Before connecting cables, ensure that the equipment is intact. Otherwise, electric shocks or fire may occur.

 **DANGER**

Non-standard and improper operations may result in fire or electric shocks.

 **DANGER**

Prevent foreign matter from entering the equipment during operations. Otherwise, equipment damage, load power derating, power failure, or personal injury may occur.

 **WARNING**

For the equipment that needs to be grounded, install the ground cable first when installing the equipment and remove the ground cable last when removing the equipment.

 CAUTION

Do not route cables near the air intake or exhaust vents of the equipment.

General Requirements

- Follow the procedures described in the document for installation, operation, and maintenance. Do not reconstruct or alter the equipment, add components, or change the installation sequence without permission.
- Obtain approval from the national or local electric utility company before connecting the equipment to the grid.
- Observe the power plant safety regulations, such as the operation and work ticket mechanisms.
- Install temporary fences or warning ropes and hang "No Entry" signs around the operation area to keep unauthorized personnel away from the area.
- Before installing or removing power cables, turn off the switches of the equipment and its upstream and downstream switches.
- Before performing operations on the equipment, check that all tools meet the requirements and record the tools. After the operations are complete, collect all of the tools to prevent them from being left inside the equipment.
- Before installing power cables, check that cable labels are correct and cable terminals are insulated.
- When installing the equipment, use a torque tool of a proper measurement range to tighten the screws. When using a wrench to tighten the screws, ensure that the wrench does not tilt and the torque error does not exceed 10% of the specified value.
- Ensure that bolts are tightened with a torque tool and marked in red and blue after double-check. Installation personnel mark tightened bolts in blue. Quality inspection personnel confirm that the bolts are tightened and then mark them in red. (The marks must cross the edges of the bolts.)

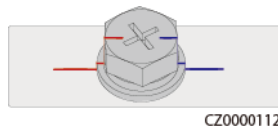

- If the equipment has multiple inputs, disconnect all the inputs before operating the equipment.
- Before maintaining a downstream electrical or power distribution device, turn off the output switch on the power supply equipment.
- During equipment maintenance, attach "Do not switch on" labels near the upstream and downstream switches or circuit breakers as well as warning signs to prevent accidental connection. The equipment can be powered on only after troubleshooting is complete.
- Do not open equipment panels.
- Check equipment connections periodically, ensuring that all screws are securely tightened.
- Only qualified professionals can replace a damaged cable.
- Do not scrawl, damage, or block any labels or nameplates on the equipment. Promptly replace labels that have worn out.

- Do not use solvents such as water, alcohol, or oil to clean electrical components inside or outside of the equipment.

Grounding

- Ensure that the grounding impedance of the equipment complies with local electrical standards.
- Ensure that the equipment is connected permanently to the protective ground. Before operating the equipment, check its electrical connection to ensure that it is reliably grounded.
- Do not work on the equipment in the absence of a properly installed ground conductor.
- Do not damage the ground conductor.

Cabling Requirements

- When selecting, installing, and routing cables, follow local safety regulations and rules.
- When routing power cables, ensure that there is no coiling or twisting. Do not join or weld power cables. If necessary, use a longer cable.
- Ensure that all cables are properly connected and insulated, and meet specifications.
- Ensure that the slots and holes for routing cables are free from sharp edges, and that the positions where cables are routed through pipes or cable holes are equipped with cushion materials to prevent the cables from being damaged by sharp edges or burrs.
- Ensure that cables of the same type are bound together neatly and straight and that the cable sheath is intact. When routing cables of different types, ensure that they are away from each other without entanglement and overlapping.
- Secure buried cables using cable supports and cable clips. Ensure that the cables in the backfill area are in close contact with the ground to prevent cable deformation or damage during backfilling.
- If the external conditions (such as the cable layout or ambient temperature) change, verify the cable usage in accordance with the IEC-60364-5-52 or local laws and regulations. For example, check that the current-carrying capacity meets requirements.
- When routing cables, reserve at least 30 mm clearance between the cables and heat-generating components or areas. This prevents deterioration or damage to the cable insulation layer.

1.3 Environment Requirements

 **DANGER**

Do not expose the equipment to flammable or explosive gas or smoke. Do not perform any operation on the equipment in such environments.

 **DANGER**

Do not store any flammable or explosive materials in the equipment area.

 **DANGER**

Do not place the equipment near heat sources or fire sources, such as smoke, candles, heaters, or other heating devices. Overheat may damage the equipment or cause a fire.

 **WARNING**

Install the equipment in an area far away from liquids. Do not install it under areas prone to condensation, such as under water pipes and air exhaust vents, or areas prone to water leakage, such as air conditioner vents, ventilation vents, or feeder windows of the equipment room. Ensure that no liquid enters the equipment to prevent faults or short circuits.

 **WARNING**

To prevent damage or fire due to high temperature, ensure that the ventilation vents or heat dissipation systems are not obstructed or covered by other objects while the equipment is running.

General Requirements

- Ensure that the equipment is stored in a clean, dry, and well ventilated area with proper temperature and humidity and is protected from dust and condensation.
- Keep the installation and operating environments of the equipment within the allowed ranges. Otherwise, its performance and safety will be compromised.
- Do not install, use, or operate outdoor equipment and cables (including but not limited to moving equipment, operating equipment and cables, inserting connectors to or removing connectors from signal ports connected to outdoor facilities, working at heights, performing outdoor installation, and opening doors) in harsh weather conditions such as lightning, rain, snow, and level 6 or stronger wind.
- Do not install the equipment in an environment with dust, smoke, volatile or corrosive gases, infrared and other radiations, organic solvents, or salty air.
- Do not install the equipment in an environment with conductive metal or magnetic dust.
- Do not install the equipment in an area conducive to the growth of microorganisms such as fungus or mildew.
- Do not install the equipment in an area with strong vibration, noise, or electromagnetic interference.

- Ensure that the site complies with local laws, regulations, and related standards.
- Ensure that the ground in the installation environment is solid, free from spongy or soft soil, and not prone to subsidence. The site must not be located in a low-lying land prone to water or snow accumulation, and the horizontal level of the site must be above the highest water level of that area in history.
- Do not install the equipment in a position that may be submerged in water.
- If the inverter is installed in a place with abundant vegetation, in addition to routine weeding, harden the ground underneath the inverter using cement or gravel (the area shall be greater than or equal to 3 m x 2.5 m).
- Do not install the equipment outdoors in salt-affected areas because it may be corroded. A salt-affected area refers to the region within 500 m of the coast or prone to sea breeze. Regions prone to sea breeze vary with weather conditions (such as typhoons and monsoons) or terrains (such as dams and hills).
- Before installation, operation, and maintenance, clean up any water, ice, snow, or other foreign objects on the top of the equipment.
- When installing the equipment, ensure that the installation surface is solid enough to bear the weight of the equipment.
- After installing the equipment, remove the packing materials such as cartons, foam, plastics, and cable ties from the equipment area.

1.4 Mechanical Safety

 **WARNING**

Ensure that all necessary tools are ready and inspected by a professional organization. Do not use tools that have signs of scratches or fail to pass the inspection or whose inspection validity period has expired. Ensure that the tools are secure and not overloaded.

 **WARNING**

Do not drill holes into the equipment. Doing so may affect the sealing performance and electromagnetic containment of the equipment and damage components or cables inside. Metal shavings from drilling may short-circuit boards inside the equipment.

General Requirements

- Repaint any paint scratches caused during equipment transportation or installation in a timely manner. Equipment with scratches must not be exposed for an extended period of time.
- Do not perform operations such as arc welding and cutting on the equipment without evaluation by the Company.

- Do not install other devices on the top of the equipment without evaluation by the Company.
- When performing operations over the top of the equipment, take measures to protect the equipment against damage.
- Use correct tools and operate them in the correct way.

Moving Heavy Objects

- Be cautious to prevent injury when moving heavy objects.

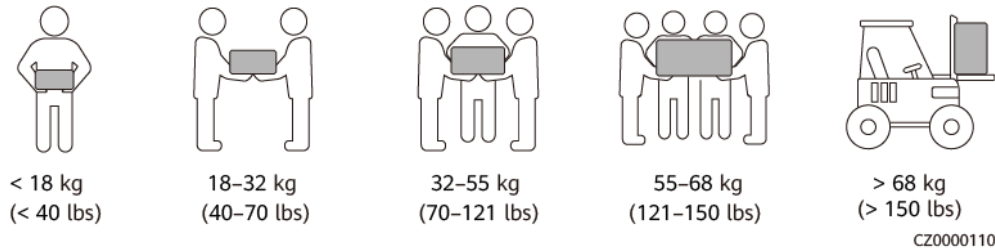

- If multiple persons need to move a heavy object together, determine the manpower and work division with consideration of height and other conditions to ensure that the weight is equally distributed.
- If two persons or more move a heavy object together, ensure that the object is lifted and landed simultaneously and moved at a uniform pace under the supervision of one person.
- Wear personal protective gears such as protective gloves and shoes when manually moving the equipment.
- To move an object by hand, approach to the object, squat down, and then lift the object gently and stably by the force of the legs instead of your back. Do not lift it suddenly or turn your body around.
- Do not quickly lift a heavy object above your waist. Place the object on a workbench that is half-waist high or any other appropriate place, adjust the positions of your palms, and then lift it.
- Move a heavy object stably with balanced force at an even and low speed. Put down the object stably and slowly to prevent any collision or drop from scratching the surface of the equipment or damaging the components and cables.
- When moving a heavy object, be aware of the workbench, slope, staircase, and slippery places. When moving a heavy object through a door, ensure that the door is wide enough to move the object and avoid bumping or injury.
- When transferring a heavy object, move your feet instead of turning your waist around. When lifting and transferring a heavy object, ensure that your feet point to the target direction of movement.
- When transporting the equipment using a pallet truck or forklift, ensure that the tynes are properly positioned so that the equipment does not topple. Before moving the equipment, secure it to the pallet truck or forklift using ropes. When moving the equipment, assign dedicated personnel to take care of it.
- Choose sea, roads in good conditions, or airplanes for transportation. Do not transport the equipment by railway. Avoid tilt or jolt during transportation.

Using Ladders

- Use wooden or insulated ladders when you need to perform live-line working at heights.
- Platform ladders with protective rails are preferred. Single ladders are not recommended.
- Before using a ladder, check that it is intact and confirm its load bearing capacity. Do not overload it.
- Ensure that the ladder is securely positioned and held firm.



CZ00000107

- When climbing up the ladder, keep your body stable and your center of gravity between the side rails, and do not overreach to the sides.
- When a step ladder is used, ensure that the pull ropes are secured.
- If a single ladder is used, the recommended angle for the ladder against the floor is 75 degrees, as shown in the following figure. A square can be used to measure the angle.

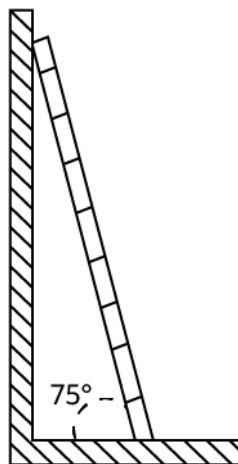

PI025C0008

- If a single ladder is used, ensure that the wider end of the ladder is at the bottom, and take protective measures to prevent the ladder from sliding.
- If a single ladder is used, do not climb higher than the fourth rung of the ladder from the top.
- If you use a single ladder to climb up to a platform, ensure that the ladder is at least 1 m higher than the platform.

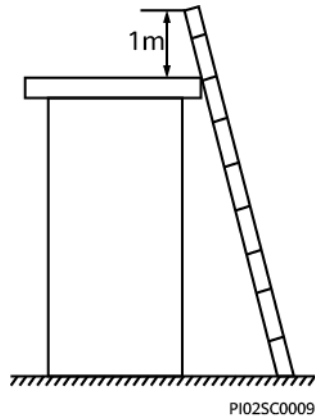

Hoisting

- Only trained and qualified personnel are allowed to perform hoisting operations.
- Install temporary warning signs or fences to isolate the hoisting area.
- Ensure that the foundation where hoisting is performed on meets the load-bearing requirements.
- Before hoisting objects, ensure that hoisting tools are firmly secured onto a fixed object or wall that meets the load-bearing requirements.
- During hoisting, do not stand or walk under the crane or the hoisted objects.
- Do not drag steel ropes and hoisting tools or bump the hoisted objects against hard objects during hoisting.
- Ensure that the angle between two hoisting ropes is no more than 90 degrees, as shown in the following figure.

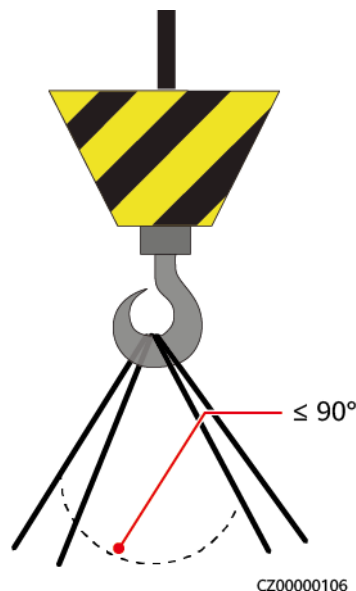

Drilling Holes

- Obtain consent from the customer and contractor before drilling holes.
- Wear protective equipment such as safety goggles and protective gloves when drilling holes.

- To avoid short circuits or other risks, do not drill holes into buried pipes or cables.
- When drilling holes, protect the equipment from shavings. After drilling, clean up any shavings.

2 Product Description

Functions

- The SmartGuard can implement on/off-grid switchover and load management. Its main function is to switch the inverter between on-grid and off-grid modes. When the grid is available, the inverter works in on-grid mode, and the grid and inverter ensure power supply to both backup loads and non-backup loads. When the grid fails, the inverter quickly switches to off-grid mode and supplies power to backup loads only until the grid recovers.
- The SmartGuard contains the EMMA, which can connect to PV, ESSs, smart chargers, and smart loads. In addition to unified scheduling of home energy, the EMMA can connect to smart loads such as chargers, SG Ready heat pumps, and smart switches. Users can set the reservation time to charge vehicles and heat water in advance at the specified time. In addition, users can set PV energy usage priorities for devices as required to make the best use of PV energy.

2.1 Model Number Description

This document involves the following product models:

- SmartGuard-63A-S0
- SmartGuard-63A-AUS0

Figure 2-1 Model number

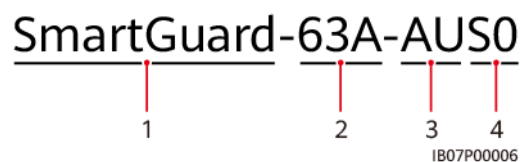

Table 2-1 Model number description

No.	Item	Description
1	Product family name	SmartGuard: Whole Home Backup

No.	Item	Description
2	Maximum current	63A: The total load current is less than or equal to 63 A. The maximum current of the grid port is 63 A.
3	Region	AU: Australia/New Zealand
4	Product code	S0: Single-phase Whole Home Backup system

2.2 Networking

Residential Load Classification

CAUTION

- The SmartGuard applies to the scenario where the main circuit breaker is less than or equal to 63 A. If the current is greater than 63 A, do not install the SmartGuard.
- If the power of backup loads exceeds the maximum off-grid power of the system, the inverter may be shut down due to overload. In this case, you need to shut down some loads or connect unimportant loads to the non-backup power port.

Figure 2-2 Residential load classification (dashed boxes indicate optional components)

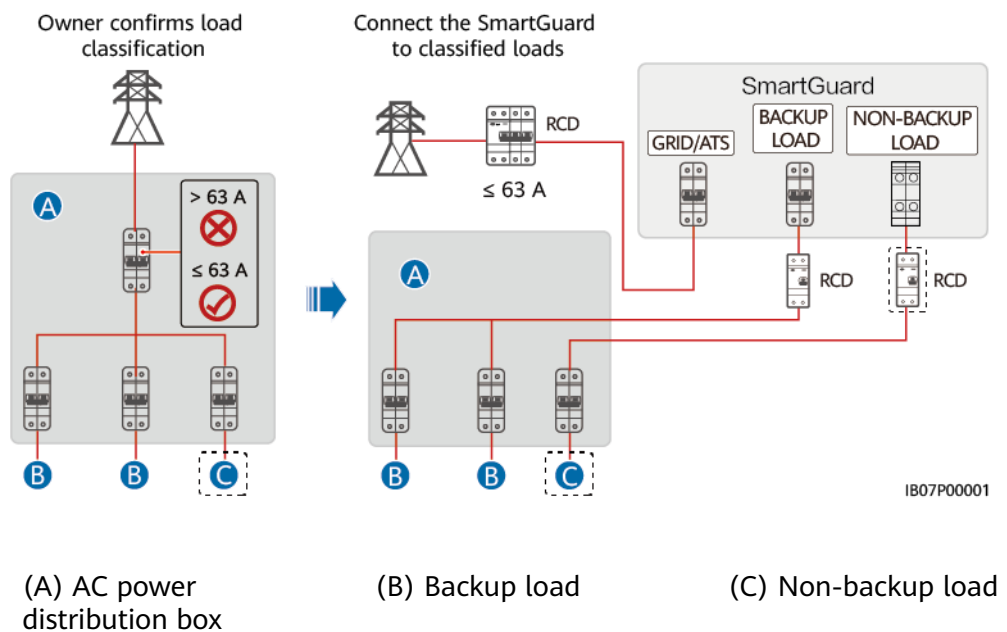

Residential Wiring Diagrams

Figure 2-3 SmartGuard-63A-S0 residential wiring diagram (dashed lines indicate optional cable connections)

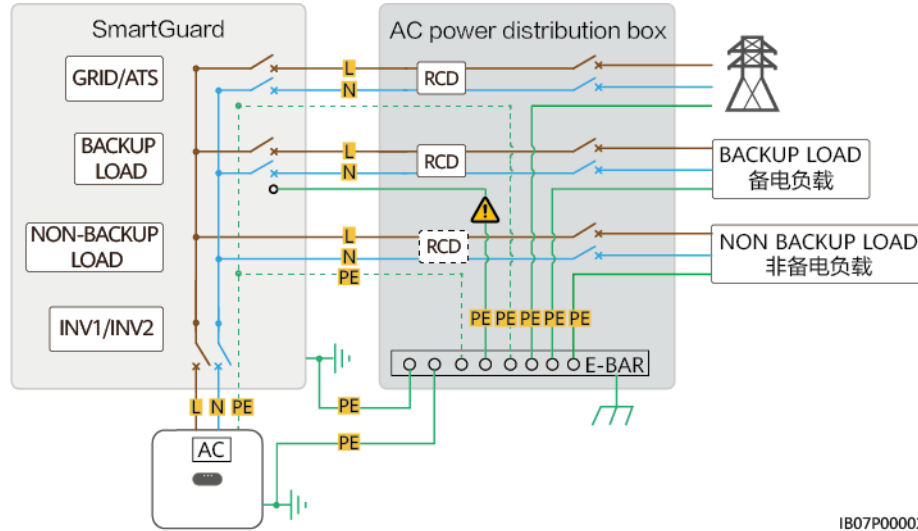

IB07P00002

NOTE

The PE cable with  must be connected to the PE bar of the AC power distribution box.

Figure 2-4 SmartGuard-63A-AUS0 residential wiring diagram (dashed lines indicate optional cable connections)



IB07P00003

Networking

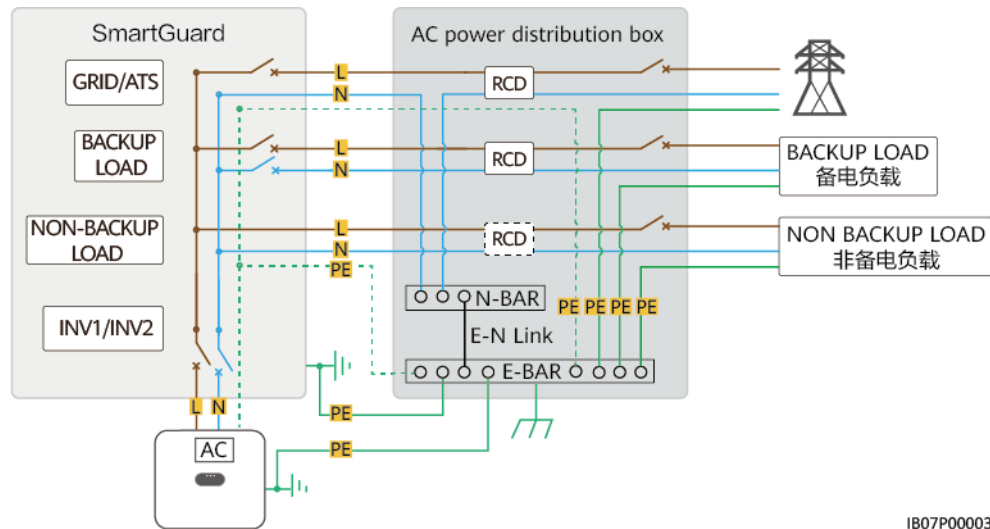
The SmartGuard is used in a residential rooftop on/off-grid system. The system consists of the PV strings, ESS, inverter, SmartGuard, grid, and loads.

Figure 2-5 Networking (dashed boxes indicate optional components)

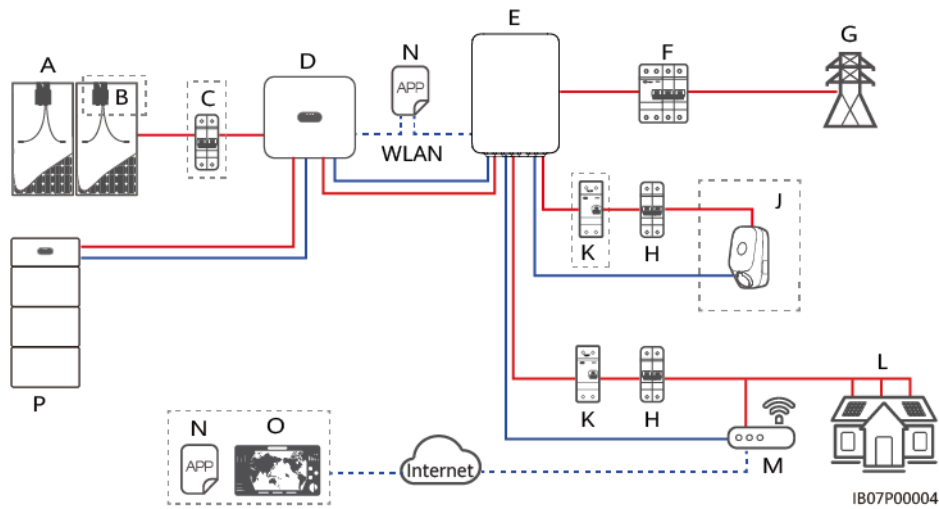



- | | | |
|-------------------------------------|--|--------------------------|
| (A) PV string | (B) Smart PV Optimizer | (C) DC switch |
| (D) SUN2000 | (E) SmartGuard | (F) Main circuit breaker |
| (G) Power grid | (H) AC power distribution units | (J) Non-backup load |
| (K) Residual current devices (RCDs) | (L) Backup load | (M) Router |
| (N) FusionSolar app | (O) FusionSolar Smart PV Management System (SmartPVMS) | (P) LUNA2000 |

⚠ DANGER

- An RCD must be installed before the backup load. During off-grid operation, the main circuit breaker does not provide protection. Electric leakage on the loads may result in electric shocks.
- The main circuit breaker with the leakage protection function must be installed. The rated leakage current must be greater than or equal to the number of inverters multiplied by 100 mA.

 NOTE

-  indicates a power cable,  indicates a signal cable, and  indicates wireless communication.
- If a charger is configured, the charger must be installed on a non-backup power port.
- The SmartGuard contains the EMMA. The EMMA can be connected to the router through the FE or WLAN port. If WLAN is used, the router must be close to the SmartGuard.
- If there is only one charger, it can be directly connected to the EMMA through the FE port or connected to the router through the FE or WLAN port. If there are two chargers, they must be connected to the router only through the FE or WLAN port. Do not connect one charger to the EMMA and the other charger to the router respectively at the same time.
- When the SG Ready heat pump provides 12 V power supply, the EMMA directly controls the heat pump. When the SG Ready heat pump cannot provide 12 V power supply, the EMMA controls the heat pump through an external relay.
- The EMMA allows smart switch devices (including smart sockets, smart circuit breakers, and smart relays) to connect to the router through the FE or WLAN port.

System Power in Off-Grid Mode

 NOTE

The maximum system power in off-grid mode depends on the ESS capacity and inverter power. For details about how to configure the ESS capacity, see [LUNA2000-\(5-30\)-S0 User Manual](#).

Table 2-2 SUN2000-(2KTL-6KTL)-L1

Parameter	SUN2000-2KTL-L1	SUN2000-3KTL-L1	SUN2000-3.68KTL-L1	SUN2000-4KTL-L1	SUN2000-4.6KTL-L1	SUN2000-5KTL-L1	SUN2000-6KTL-L1
Off-grid power	2000 W	3000 W	3680 W	4000 W	4600 W	5000 W	5000 W
Charging power from grid to inverter	2200 W	3000 W	3000 W	3000 W	3000 W	3000 W	3000 W

Table 2-3 SUN2000-(8KTL, 10KTL)-LC0

Parameter	SUN2000-8K-LC0	SUN2000-10K-LC0	SUN2000-8K-LC0-ZH	SUN2000-10K-LC0-ZH
Off-grid power	8000 W	10,000 W	8000 W	10,000 W
Charging power from grid to inverter	5000 W	5000 W	5000 W	5000 W

Residential Load Features

1. When the inverter is off-grid, the peak load current and duration shall not exceed the off-grid running capability of the inverter. The stable running of the system is affected by both the continuous load power and the inrush current during load startup.
2. To ensure that loads can start and run properly, do not start the following typical devices at the same time.

Table 2-4 Residential load features

Load Feature	Load	Cause
High startup current (motor)	Air conditioners, electric saws, and pumps	Load startup requires a high startup current, which may exceed the maximum output current of the inverter. Although the load power is within the off-grid operating power range of the inverter, the loads may fail to start.
Dynamic power	Washing machines, soy milk makers, rice cookers, and electric ovens	When the system is running properly, the power of adjacent running loads is fluctuating.
High harmonic current	Induction cookers and hair dryers	The non-sinusoidal current may cause total harmonic distortion of output voltage (THDv).

Supported Earthing Systems

The SmartGuard supports TN-S, TN-C-S, and TT systems. In the TT power grid, the N-to-PE voltage must be less than 30 V.

Figure 2-6 Earthing systems

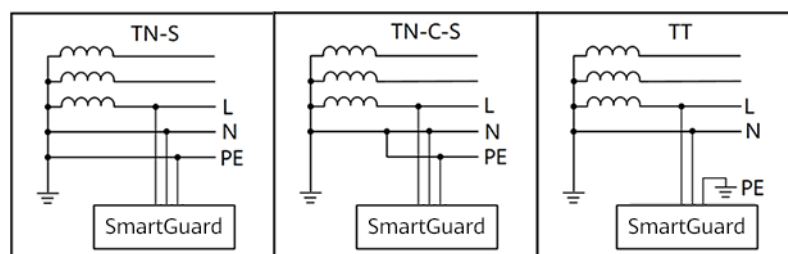

2.3 Appearance

Appearance and Ports

Figure 2-7 Appearance and ports

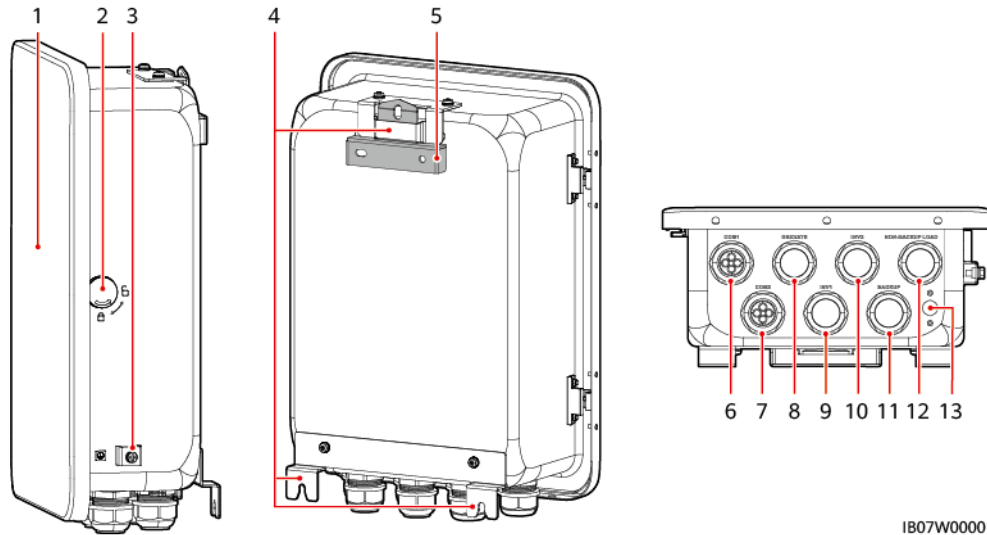

IB07W00001

- | | |
|---|---|
| (1) Maintenance compartment door ^a | (2) Lock |
| (3) Ground screw | (4) Mounting kits |
| (5) Mounting bracket | (6) Communications port (COM1) |
| (7) Communications port (COM2) | (8) Grid AC output port (GRID/ATS) |
| (9) Inverter AC input port (INV1 63A) | (10) Inverter AC input port (INV2 32A) |
| (11) Backup load port (BACKUP LOAD) | (12) Non-backup load port (NON-BACKUP LOAD) |
| (13) Ventilation valve | |

NOTE

Note a: Before opening the maintenance compartment door, turn off the main circuit breaker on the grid side, shut down the inverter, and turn off the DC switches of the inverter and ESS.

Maintenance Compartment and Wiring Terminals

Figure 2-8 Maintenance compartment and wiring terminals

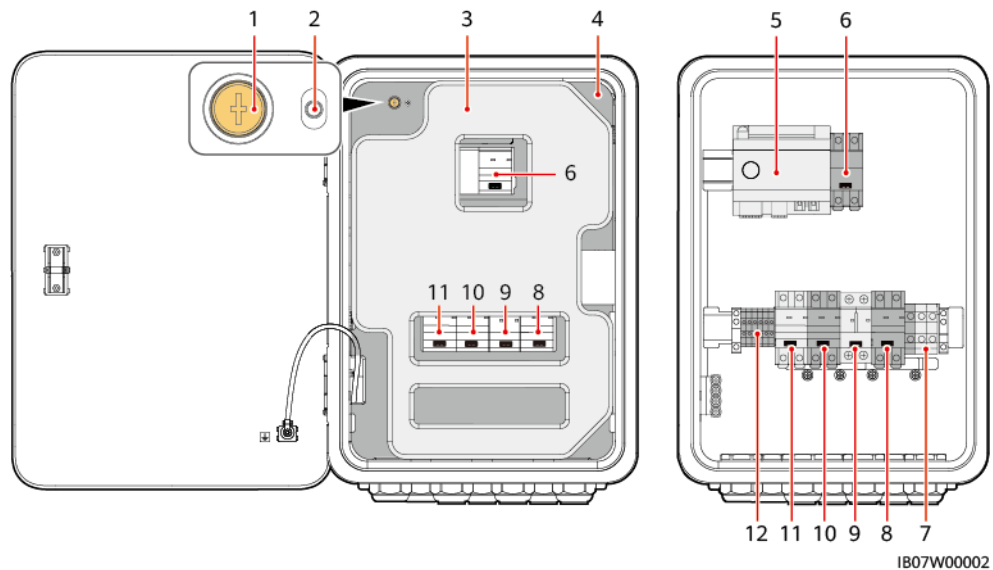

(1) Screw on the maintenance compartment cover

(2) LED indicator

(3) Cushioning material^c

(4) Maintenance compartment cover^a

(5) EMMA

(6) Bypass switch^b

(7) Non-backup load terminal (NON-BACKUP LOAD)

(8) Backup load terminal (BACKUP LOAD)

(9) Inverter AC input terminal 2 (INV2)

(10) Inverter AC input terminal 1 (INV1)

(11) Grid AC output terminal (GRID/ATS)

(12) Signal cable terminal of the SmartGuard

WARNING

Note a: Only authorized personnel can open the maintenance compartment cover to perform electrical connections.

Note b: During deployment and normal use, do not operate the bypass switch. Ensure that the bypass switch is off.

NOTE

Note c: Dispose of the removed cushioning material according to waste sorting regulations.

2.4 Electrical Diagram

Figure 2-9 Electrical diagram of the SmartGuard

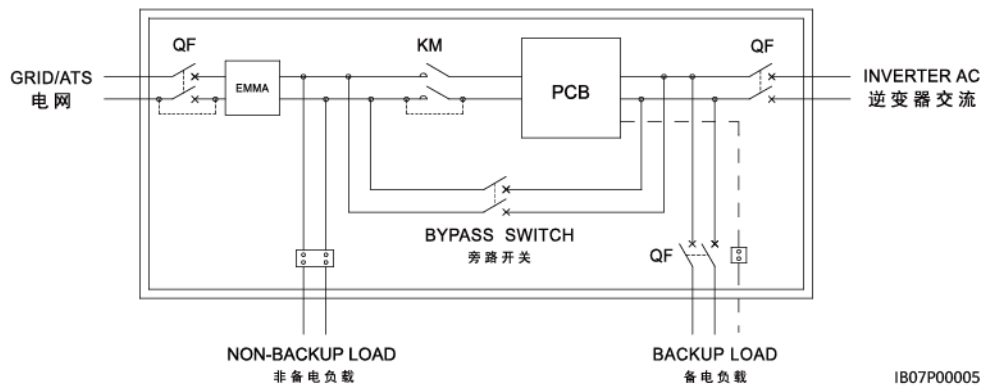

2.5 Working Modes

- The SmartGuard can work in on-grid or off-grid mode.
- Power supply priority: on-grid > off-grid

Figure 2-10 Working modes

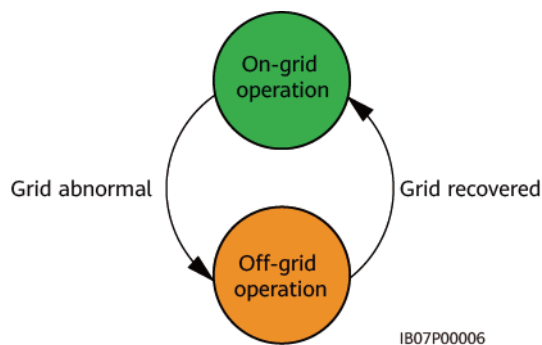







Table 2-5 Working mode switchover





Switchover Mode	Description
Automatic switchover	<ul style="list-style-type: none"> • The SmartGuard automatically switches the working mode based on actual conditions and working conditions. • Seamless switchover from on-grid mode to off-grid mode can be enabled or disabled. For details, see 6.4.3 Setting Seamless Handover.

2.6 Label Description

Enclosure Labels

Table 2-6 Enclosure label description

Label	Name	Description
	Electric shock warning	Only authorized personnel can open the maintenance compartment cover.
	Refer to documentation	Reminds operators to read the user manual of the SmartGuard.
	Operation warning	<ul style="list-style-type: none"> During deployment and normal use, do not operate the bypass switch. Ensure that the bypass switch is off. If the SmartGuard is abnormal and cannot work, consult the customer service personnel and refer to 7.4 Operations on the Bypass Switch of the SmartGuard. Improper operations may cause electric shocks.
	Electric shock warning	Cut off power supply and remove metal objects such as watches and rings before maintenance.
	Delayed discharge	<ul style="list-style-type: none"> High voltage exists after the SmartGuard is powered on. Only qualified and trained electrical technicians are allowed to install and operate the SmartGuard. Residual voltage exists after the SmartGuard is powered off. It takes 5 minutes for the SmartGuard to discharge to the safe voltage.

Label	Name	Description
	Burn warning	Do not touch the SmartGuard, as the enclosure is hot when the SmartGuard is running.
	Grounding warning	Ground the SmartGuard before powering it on.
	ESD label	Do not touch the boards in the SmartGuard.
	QR code for WLAN connection	Scan the QR code to connect to the WLAN of the SmartGuard.
	Grounding	Indicates the position for connecting the PE cable.

Product Nameplate

Figure 2-11 Nameplate (SmartGuard-63A-S0 as an example)

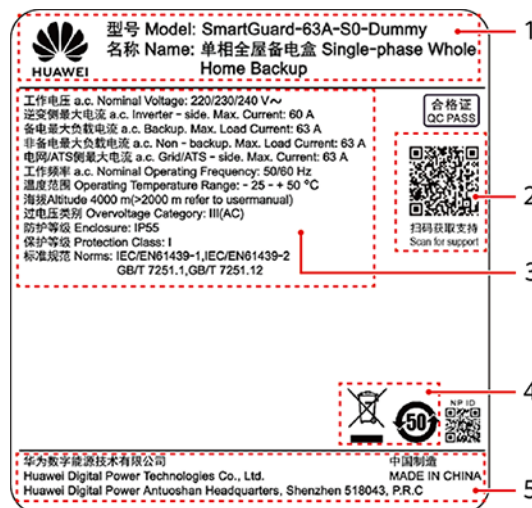

- (1) Trademark and model
- (2) QR code for accessing product documentation
- (3) Key technical specifications
- (4) Compliance symbols
- (5) Company name and country of origin

 **NOTE**

The nameplate figure is for reference only.

3 Storage Requirements

If the SmartGuard is not put into use immediately, the following requirements must be met when the SmartGuard is stored:

- Do not unpack the SmartGuard.
- Keep the storage temperature at -40°C to $+70^{\circ}\text{C}$ and the humidity at 5%–95% RH.
- Store the SmartGuard in a clean and dry place and protect it from dust and moisture.
- The SmartGuard can be stacked in a maximum of six layers. To avoid personal injury or device damage, stack the SmartGuard with caution to prevent them from falling over.
- During the storage period, check the SmartGuard periodically (recommended: once every three months). Replace the packing materials that are damaged by insects or rodents in a timely manner.
- If the SmartGuard has been stored for more than two years, it must be checked and tested by professionals before use.

4 System Installation

4.1 Installation Modes

The SmartGuard can be installed on a wall or a support.

Table 4-1 Installation modes

Installation Mode	Screw Specifications	Description
Wall mounting	M6x60 stainless steel expansion bolt	Delivered with the product
Support mounting	M6 stainless steel bolt assembly	Prepared by the customer

4.2 Installation Position

4.2.1 Site Selection Requirements

Basic Requirements

- The SmartGuard is protected to IP55 and can be installed indoors or outdoors.
- Do not install the SmartGuard in a position where it is easy to touch because the enclosure temperature is high when the SmartGuard is running.
- Do not install the SmartGuard near flammable or explosive materials.
- Keep the SmartGuard out of reach of children.
- The SmartGuard will be corroded in salt-affected areas, and the salt corrosion may cause fire. Do not install the SmartGuard outdoors in salt-affected areas. A salt-affected area refers to the region within 500 m of the coast or prone to sea breeze. Regions prone to sea breeze vary with weather conditions (such as typhoons and monsoons) or terrains (such as dams and hills).

- Install the SmartGuard in a well-ventilated environment to ensure good heat dissipation.
- You are advised to install the SmartGuard in a sheltered area or install an awning over it.
- Do not install the SmartGuard in a place with direct sunlight exposure. Otherwise, the capacity may decrease or overtemperature protection may be triggered.
- It is recommended that the SmartGuard be installed beside the AC power distribution box and be far away from the rest area. When the SmartGuard performs on/off-grid switchover, a click sound is generated.

Mounting Structure Requirements

- Ensure that the structure where the SmartGuard is installed is fireproof.
- Do not install the SmartGuard on flammable building materials.
- Verify that the surface on which the SmartGuard is installed is strong enough to bear the weight of the SmartGuard.
- In residential areas, do not install the SmartGuard on a drywall or wall made of similar materials which have a weak sound insulation performance to avoid disturbing residents.

4.2.2 Clearance Requirements

Installation Clearance Requirements

- Dimensions of mounting holes for the SmartGuard

Figure 4-1 Mounting bracket dimensions

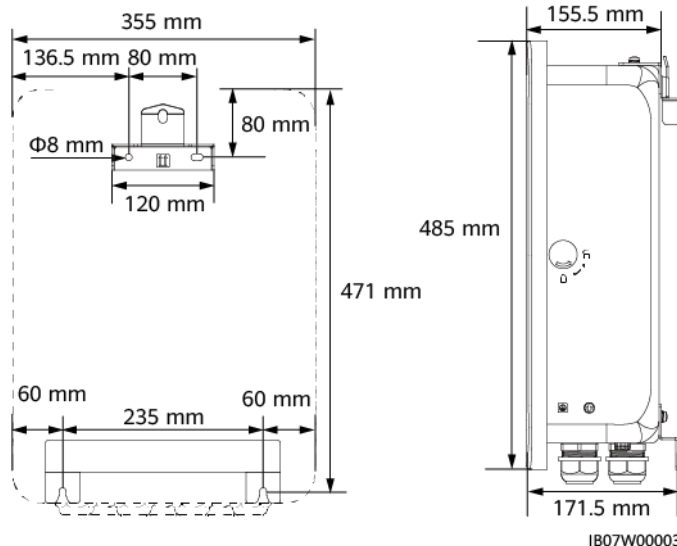

- Reserve sufficient clearances around the device for installation and heat dissipation.

Figure 4-2 Clearances

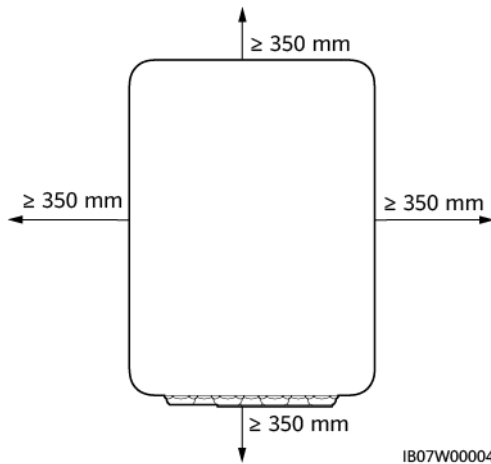

4.2.3 Angle Requirements

The installation angle requirements are as follows:



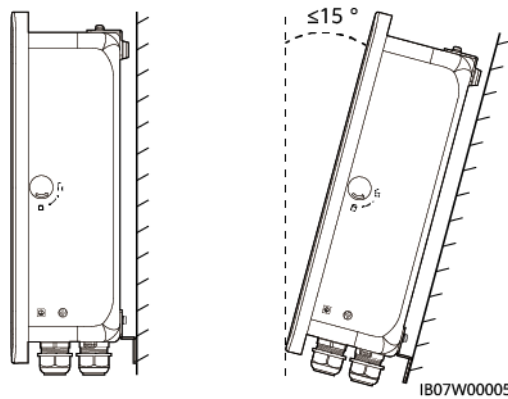

- Install the SmartGuard vertically or at a maximum back tilt of 15 degrees to facilitate heat dissipation.
- Do not install the SmartGuard at forward tilted, excessive backward tilted, side tilted, horizontal, or upside down positions.

Figure 4-3 Installation angle



4.3 Preparing Tools

Table 4-2 Personal protective equipment (PPE)

 Safety helmet	 Goggles	 Reflective vest	 Insulated shoes
--	--	---	--











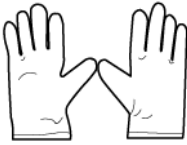



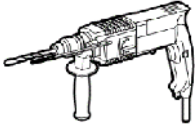





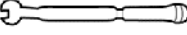

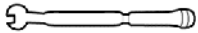

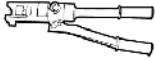

 <p>Electrostatic discharge (ESD) gloves</p>	 <p>Insulated gloves</p>	 <p>Protective gloves</p>	 <p>Dust mask</p>
---	---	---	--

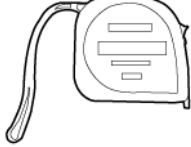
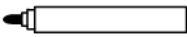
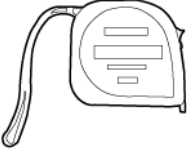
Table 4-3 Installation tools

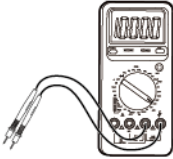
 <p>Hammer drill Drill bit: $\Phi 8$ mm, $\Phi 6$ mm</p>	  <p>Flat-head insulated torque screwdriver</p>	  <p>Phillips insulated torque screwdriver</p>	 <p>Insulated torque socket wrench</p>
 <p>Cable cutter</p>	 <p>Diagonal pliers</p>	 <p>Wire stripper</p>	 <p>Torque wrench</p>
 <p>Signal cable crimping tool</p>	 <p>Power cable crimping tool</p>	 <p>RJ45 crimping tool</p>	 <p>Hydraulic pliers</p>
 <p>Eject pin</p>	 <p>Utility knife</p>	 <p>Marker</p>	 <p>Steel measuring tape</p>

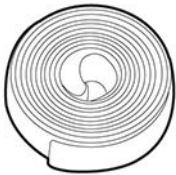
 <p>Cable tie</p>	 <p>Multimeter</p>	 <p>Level</p>	 <p>Heat-shrink tubing</p>
 <p>Heat gun</p>	 <p>Rubber mallet</p>	 <p>Vacuum cleaner</p>	<p>-</p>

4.4 Pre-installation Check

Checking Outer Packaging

Before unpacking the product, check the outer packaging for damage, such as holes and cracks, and check the product model. If any damage is found or the model is not what you requested, do not unpack the product and contact your vendor as soon as possible.

NOTICE

You are advised to remove the packing materials within 24 hours before installing the product.

Checking Deliverables

After unpacking the SmartGuard, check that the deliverables are intact and complete, and free from any obvious damage. If any item is missing or damaged, contact your vendor.

NOTE

For details about the number of deliverables, see the *Packing List* in the packing case.

4.5 Moving the SmartGuard

Put your hands on both sides of the SmartGuard, take the SmartGuard out of the packing case, and move it to the installation position.

CAUTION

- Move the SmartGuard with care to prevent device damage and personal injury.
- Do not use the wiring terminals and ports at the bottom to support any weight of the SmartGuard.
- When you need to temporarily place the SmartGuard on the ground, use foam, cardboard, or other protection material to prevent damage to its enclosure.

4.6 Wall Mounting

Procedure

- Step 1** Determine the positions for drilling holes using the marking-off plate, level the holes using a level, and mark the positions using a marker.
- Step 2** Secure the mounting bracket.

DANGER

Avoid drilling holes into the water pipes or power cables buried in the wall.

NOTE

- M6x60 expansion bolts are delivered with the product. If the length and number of the bolts do not meet installation requirements, prepare M6 stainless steel expansion bolts by yourself.
- The expansion bolts delivered with the product are used for solid brick-concrete walls. If other types of walls are used, ensure that the load-bearing capacity requirements are met and appropriate bolts are selected.
- To prevent installation failure of expansion bolts due to excessive deviation of holes on brick-concrete walls, you are advised to use small drill bits or other mounting brackets such as plastic anchor bolts to ensure reliable installation. The service life of the mounting brackets shall be at least 10 years.

Figure 4-4 Expansion bolt composition

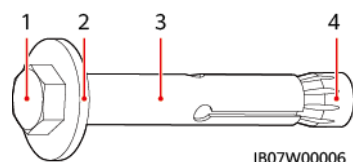

(1) Hexagonal bolt

(2) Flat washer

(3) Sleeve

(4) Conical nut

NOTICE

- To prevent dust inhalation or contact with eyes, wear safety goggles and a dust mask when drilling holes.
- Use a vacuum cleaner to clean up dust in and around the holes, and measure the spacing. If the holes are inaccurately positioned, drill the holes again.
- Partially tighten the expansion bolts, and then remove the hexagonal bolts and flat washers of the upper two expansion bolts. Loosen the hexagonal bolts and flat washers of the lower two expansion bolts.

Figure 4-5 Installing expansion bolts

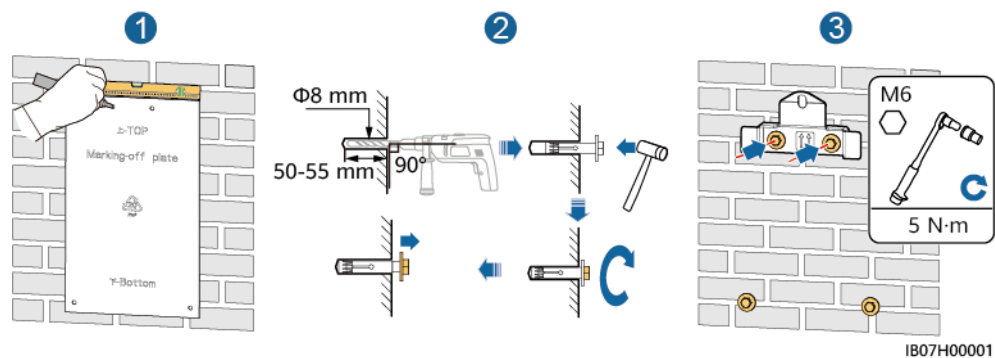

Step 3 Install the SmartGuard on the mounting bracket and tighten the nuts.

Figure 4-6 Installing the SmartGuard

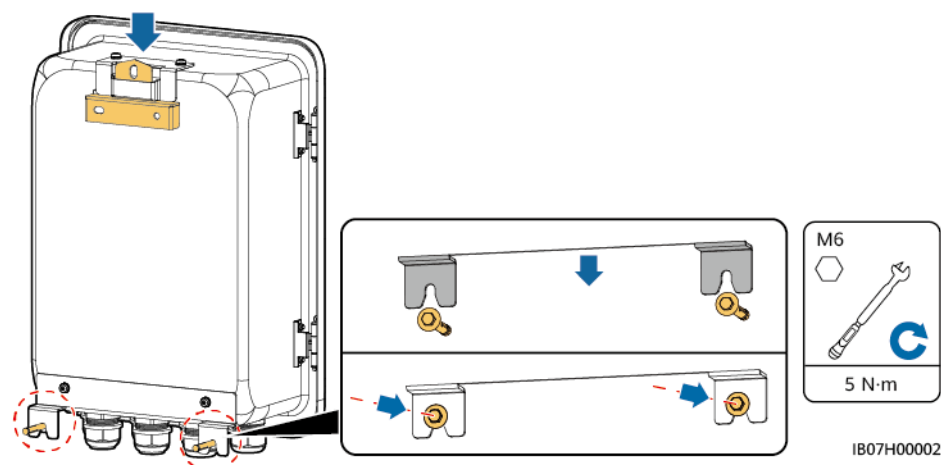

----End

4.7 Support Mounting

Prerequisites

You have prepared M6 stainless steel bolt assemblies (including flat washers, spring washers, and M6 bolts) with appropriate lengths as well as matched flat washers and nuts based on the support specifications.

Procedure

- Step 1** Determine the positions for drilling holes using the marking-off plate, and then mark the positions with a marker.

Figure 4-7 Determining hole positions

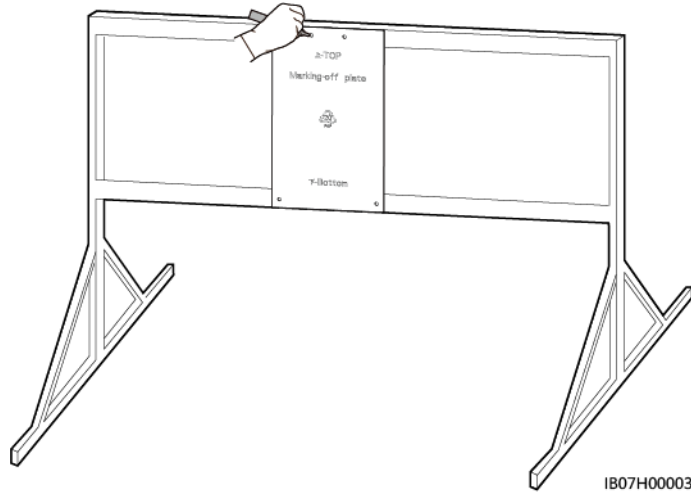

- Step 2** Drill holes using a hammer drill.

Figure 4-8 Drilling holes

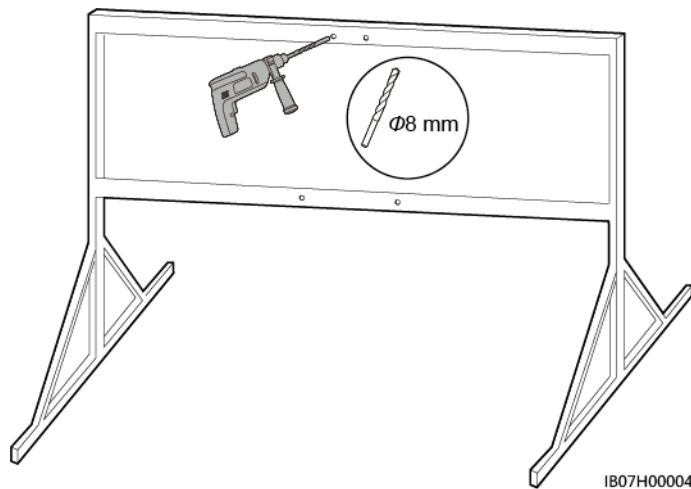

NOTE

You are advised to apply anti-rust paint on the hole positions for protection.

- Step 3** Secure the mounting bracket.

NOTICE

Pre-tighten the nuts, spring washers, and flat washers of the lower two bolt assemblies.

Figure 4-9 Securing the mounting bracket

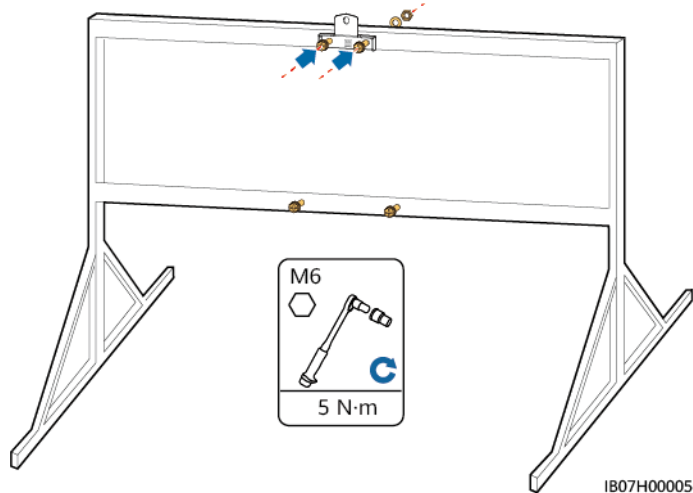

Step 4 Install the SmartGuard on the mounting bracket and tighten the nuts.

Figure 4-10 Installing the SmartGuard

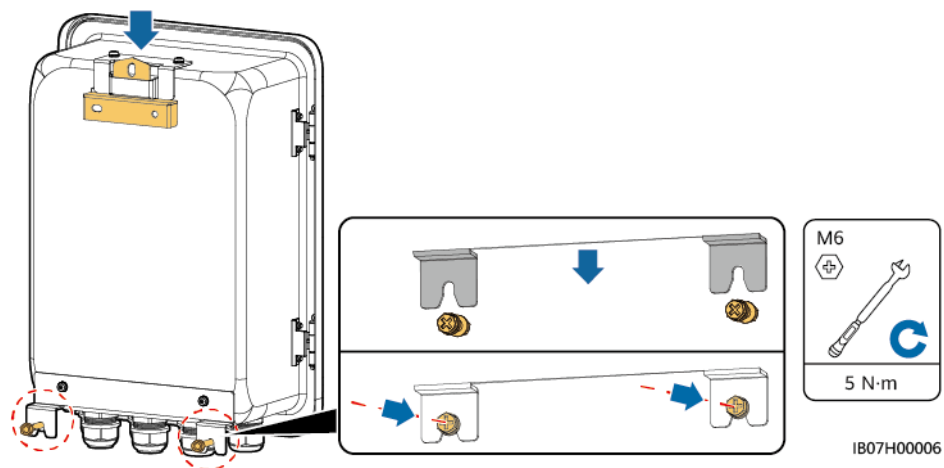

----End

5 Electrical Connections

Precautions

 **DANGER**

Before connecting cables, ensure that the circuit breaker of the SmartGuard and all connected external switches are in **OFF** state. Otherwise, the high voltage may result in electric shocks.

 **DANGER**

- The site must be equipped with qualified fire fighting facilities, such as fire sand and carbon dioxide fire extinguishers.
 - Wear PPE and use dedicated insulated tools to avoid electric shocks or short circuits.
-

 **CAUTION**

Stay away from the equipment when preparing cables to prevent cable scraps from entering the equipment. Cable scraps may cause sparks and result in personal injury and equipment damage.

 **WARNING**

- Device damage caused by incorrect cable connections is not covered by the product warranty.
 - Only qualified electrical technicians are allowed to connect cables.
 - Operation personnel must wear proper PPE when connecting cables.
 - Before connecting cables to ports, leave enough slack to reduce the tension on the cables and prevent poor cable connections.
-

NOTE

The cable colors shown in the electrical connection diagrams provided in this section are for reference only. Select cables in accordance with local cable specifications (green-and-yellow cables are only used for protective earthing).

5.1 Preparing Cables

Figure 5-1 Cable connections (dashed boxes indicate optional configuration)

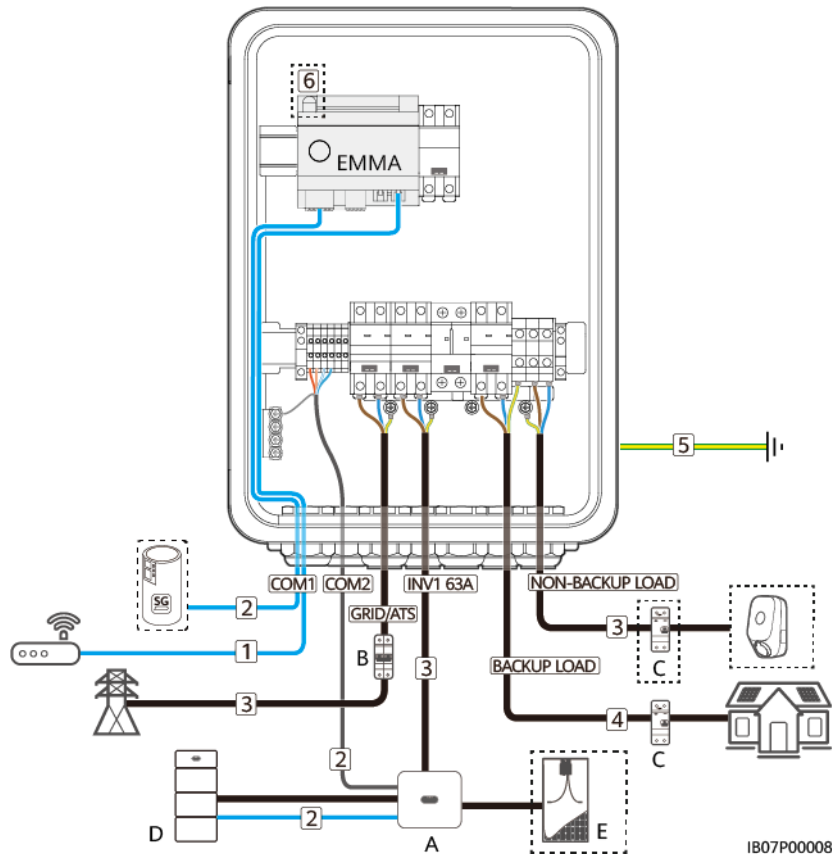

Table 5-1 Component description

No.	Component	Description	Source
A	SUN2000 ^a	<ul style="list-style-type: none"> SUN2000-(8KTL, 10KTL)-LC0 SUN2000-(2KTL-6KTL)-L1 	Purchased from Huawei
B	Main circuit breaker	The main circuit breaker with the leakage protection function must be installed. The rated voltage must be greater than or equal to 250 V AC and the rated current must be less than or equal to 63 A.	Prepared by the customer
C	RCD	An RCD must be installed before the backup load.	Prepared by the customer

No.	Component	Description	Source
D	ESS	LUNA2000-(5-30)-S0	Purchased from Huawei
E	PV string	A PV string is composed of the PV modules connected in series and works with optimizers.	Prepared by the customer

Note a: Only one inverter can be connected to the SmartGuard. The INV1 63A port applies to the SUN2000-(8KTL, 10KTL)-LC0, and the INV2 32A port applies to the SUN2000-(2KTL-6KTL)-L1. Select a port based on the inverter model.

Table 5-2 Cable description

No.	Cable	Type	Recommended Specifications	Source
1	FE communications cable (EMMA)	Recommended: a CAT 5E outdoor shielded network cable (internal resistance ≤ 1.5 ohms/10 m), and a shielded RJ45 connector	<ul style="list-style-type: none"> Conductor cross-sectional area: 0.12–0.2 mm² Cable outer diameter: 4–8 mm 	Prepared by the customer
2	Heat pump control signal cable	Two-core outdoor twisted pair cable	<ul style="list-style-type: none"> Conductor cross-sectional area: 0.2–1 mm² Cable outer diameter: 4–8 mm 	Prepared by the customer
	Battery signal cable	Two-core outdoor twisted pair cable		
	Inverter signal cable	Multi-core outdoor shielded twisted pair cable		
3	Inverter AC input power cable (INV1)	<ul style="list-style-type: none"> Not using the PE equipotential bonding point at the AC output port: two-core (L and N) outdoor copper cable Using the PE equipotential bonding point at the AC output port: three-core (L, N, and PE) outdoor copper cable 	<ul style="list-style-type: none"> Conductor cross-sectional area: <ul style="list-style-type: none"> SUN2000-(2KTL-6KTL)-L1: 6 mm² SUN2000-8K-LC0 series: 8–10 mm² SUN2000-10K-LC0 series: 10 mm² Cable outer diameter: 10–21 mm 	Prepared by the customer
	Inverter AC input power cable (INV2)			

No.	Cable	Type	Recommended Specifications	Source
	Grid AC output power cable	<ul style="list-style-type: none"> Not using the PE equipotential bonding point at the AC output port: two-core (L and N) outdoor copper cable Using the PE equipotential bonding point at the AC output port: three-core (L, N, and PE) outdoor copper cable 	<ul style="list-style-type: none"> Conductor cross-sectional area: $\leq 16 \text{ mm}^2$ Cable outer diameter: 10–21 mm 	
	AC output power cable for the non-backup load			
4	AC output power cable for the backup load ^a	SmartGuard-63A-S0: three-core outdoor copper cable (L, N, and PE)	<ul style="list-style-type: none"> Conductor cross-sectional area: $\leq 16 \text{ mm}^2$ Cable outer diameter: 10–21 mm 	Prepared by the customer
		SmartGuard-63A-AUS0: two-core outdoor copper cable (L and N)		
5	PE cable	Single-core outdoor copper cable and M6 OT terminal	Conductor cross-sectional area: $\leq 16 \text{ mm}^2$	Prepared by the customer
6	External WLAN antenna for the EMMA	External antenna with the RP-SMA-J port	-	Prepared by the customer
<p>Note a: The PE of the SmartGuard-63A-S0 backup power port needs to be connected, but the PE of the SmartGuard-63A-AUS0 backup power port does not need to be connected.</p>				

 **NOTE**

- The minimum cable cross-sectional area must meet local standards.
- The factors to be considered in cable selection include the rated current, cable type, routing mode, ambient temperature, and maximum acceptable line loss.

5.2 Connecting a PE Cable

Precautions

DANGER

- Ensure that the PE cable is securely connected. Otherwise, electric shocks may occur.
- Do not connect the neutral wire to the enclosure as a PE cable. Otherwise, electric shocks may occur.

NOTE

- The PE point at the AC output port is used only as a PE equipotential bonding point, and cannot substitute for the PE point on the enclosure.
- It is recommended that silicone grease or paint be applied around the ground terminal after the PE cable is connected.

Procedure

Step 1 Crimp an OT terminal.

NOTICE

- Avoid scratching the core wire when stripping a cable.
- The cavity formed after the conductor crimp strip of the OT terminal is crimped must wrap the core wire completely. The core wire must make close contact with the OT terminal.
- Wrap the wire crimping area with heat shrink tubing or insulation tape. The heat shrink tubing is used as an example.
- Use a heat gun carefully to avoid heat damage to the equipment.

Figure 5-2 Crimping an OT terminal

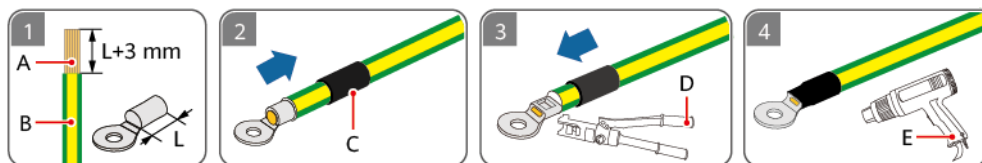

IB07150001

(A) Core wire

(B) Insulation layer

(C) Heat shrink tubing

(D) Hydraulic pliers

(E) Heat gun

Step 2 Connect the PE cable.

Figure 5-3 Connecting the PE cable

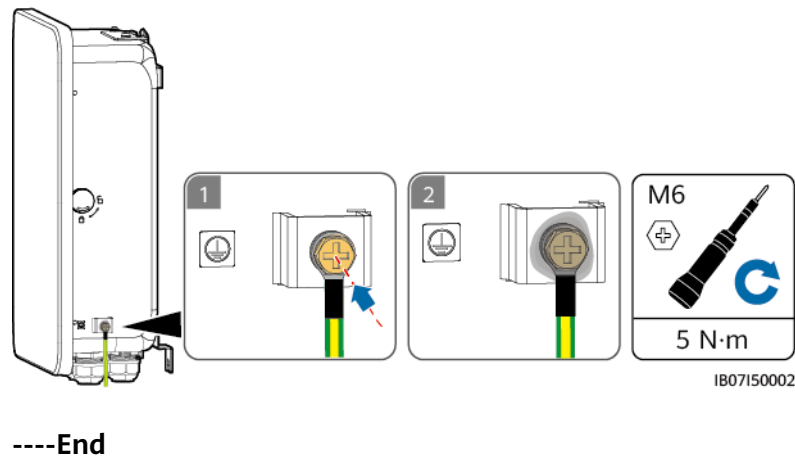

5.3 Opening the Maintenance Compartment

Precautions

⚠ DANGER

- Before opening the maintenance compartment door, turn off the main circuit breaker on the grid side, shut down the inverter, and turn off the DC switches of the inverter and ESS.
 - Before opening the maintenance compartment cover, turn off the backup load circuit breaker, grid AC circuit breaker, and two inverter AC circuit breakers inside the SmartGuard.
 - Do not operate the bypass switch during site deployment or normal use.
-

⚠ CAUTION

- If you need to open the maintenance compartment door on rainy or snowy days, take protective measures to prevent rain or snow from entering the maintenance compartment. If protective measures are unavailable, do not open the maintenance compartment door on rainy or snowy days.
 - Do not leave unused screws in the maintenance compartment.
-

Procedure

Step 1 Unlock and open the maintenance compartment door using the delivered key, and remove the cushioning material.

Figure 5-4 Opening the maintenance compartment door

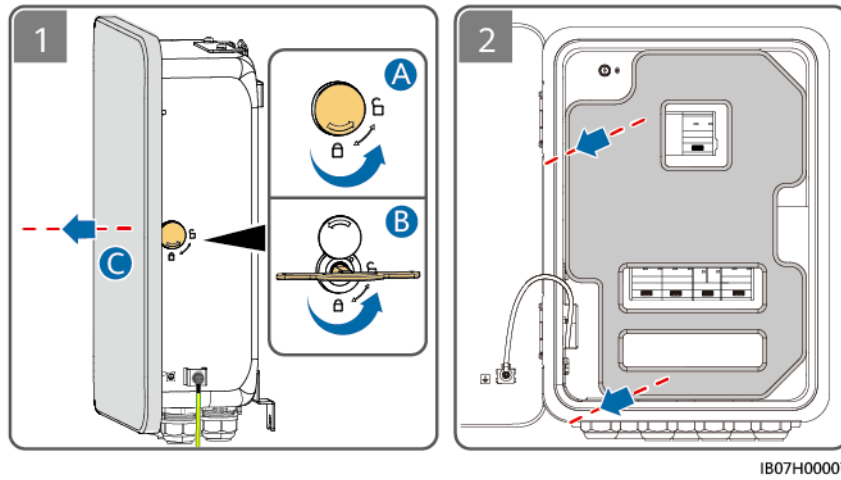

NOTE

Dispose of the removed cushioning material according to waste sorting regulations.

Step 2 Turn off the four switches shown in the figure.

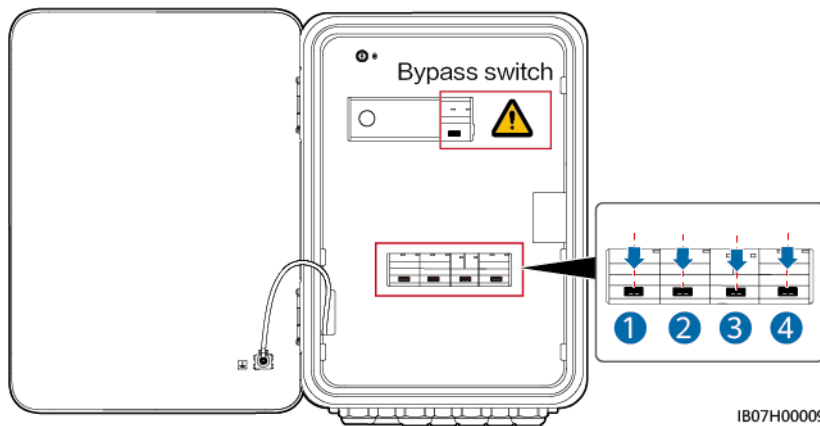

Step 3 Remove the screw from the maintenance compartment cover, and open the cover.

Figure 5-5 Opening the maintenance compartment cover

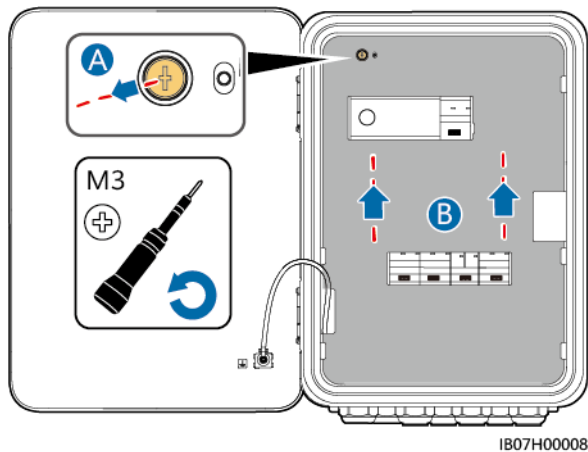

----End

5.4 Installing the Grid AC Output Power Cable

Precautions

A main circuit breaker with the leakage protection function must be installed to ensure safe disconnection from the grid. The rated leakage current must be greater than or equal to the number of inverters multiplied by 100 mA.

Procedure

- Step 1** Crimp AC cord end terminals. You can crimp AC cord end terminals for two-core or three-core cables.

 **NOTE**

The AC cord end terminals delivered with the product are mainly used for cables with a cross-sectional area of 16 mm². If cables with a cross-sectional area of less than 16 mm² are used, select AC cord end terminals that meet the requirements.

Figure 5-6 Crimping AC cord end terminals

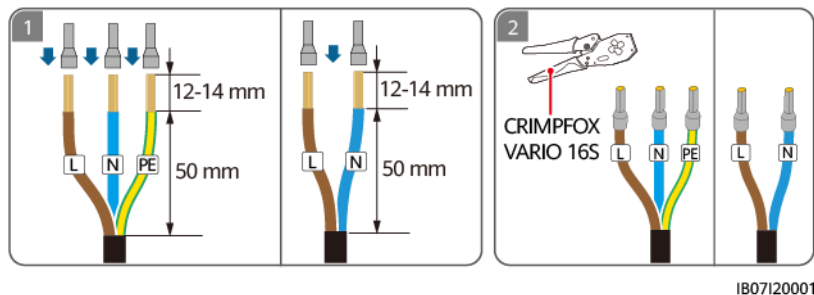

- Step 2** Connect the grid AC output power cable.

Figure 5-7 Connecting the grid AC output power cable

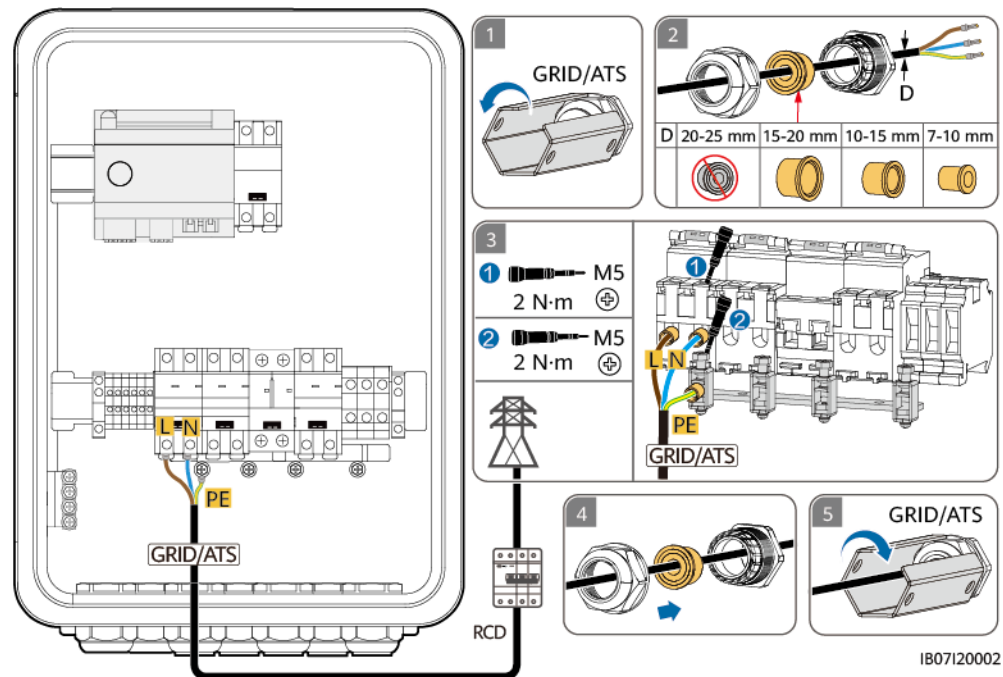

NOTICE

- The two-core cable and three-core cable are connected in the same way. The two-core cable is not connected to the PE.
- indicates that the three waterproof plugs delivered with the product are not used.
- The PE point at the AC output port is used only as a PE equipotential bonding point, and cannot substitute for the PE point on the enclosure.
- Ensure that the cable jacket is inside the connector.
- Insert the exposed core wires completely into the holes.
- Connect the AC output power cable securely. Otherwise, the device may fail to operate properly or the AC connector may be damaged.
- Ensure that the cables are not twisted.

NOTE

The cable colors shown in the figures are for reference only. Select an appropriate cable according to the local standards.

----End

5.5 Installing the Inverter AC Input Power Cable

Precautions

Shut down the inverter, and turn off the DC switches of the inverter and ESS.

Procedure

- Step 1** Crimp AC cord end terminals. You can crimp AC cord end terminals for two-core or three-core cables.

NOTE

The AC cord end terminals delivered with the product are mainly used for cables with a cross-sectional area of 16 mm². If cables with a cross-sectional area of less than 16 mm² are used, select AC cord end terminals that meet the requirements.

Figure 5-8 Crimping AC cord end terminals

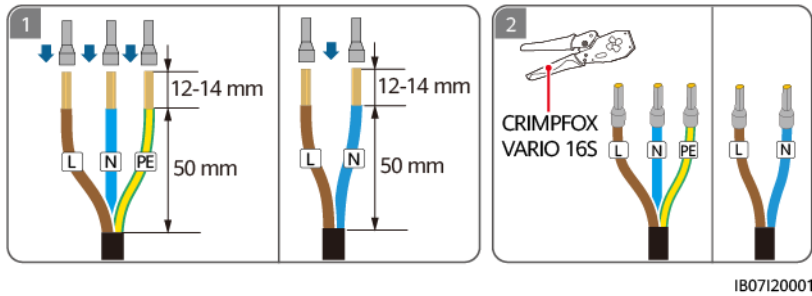

IB07120001

- Step 2** Connect the inverter AC input power cable. Currently, only one inverter can be connected to the SmartGuard. Select a port based on the inverter model.

Table 5-3 Mapping between inverter models and ports

Port	INV1 63A	INV2 32A
Inverter Model	SUN2000-(8KTL, 10KTL)-LC0	SUN2000-(2KTL-6KTL)-L1

Figure 5-9 Connecting the inverter AC input power cable

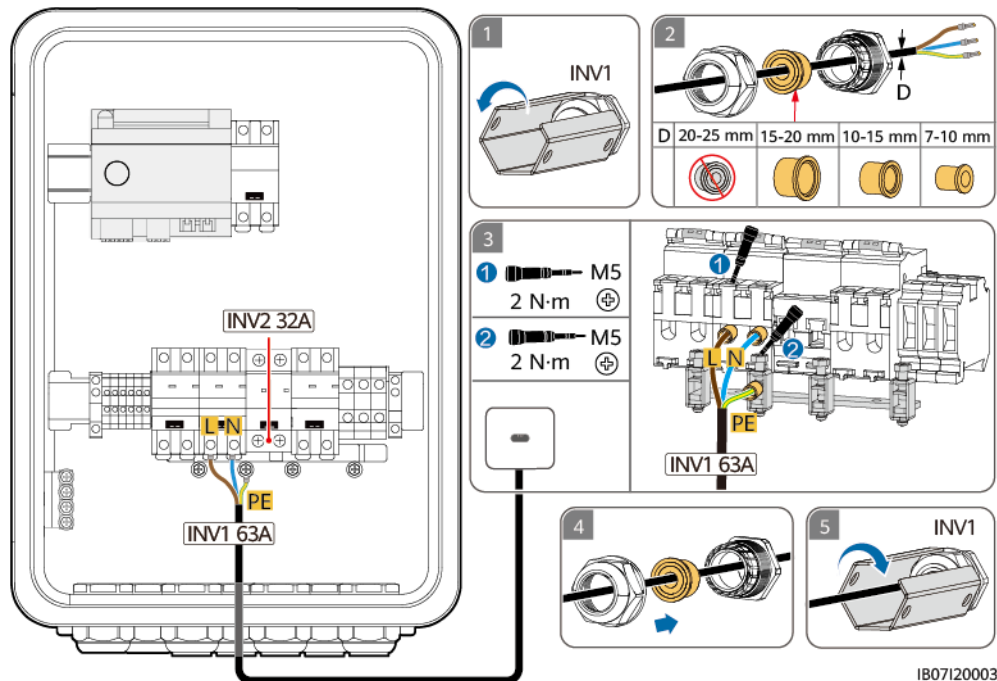

IB07120003

NOTICE

- The two-core cable and three-core cable are connected in the same way. The two-core cable is not connected to the PE.
-  indicates that the three waterproof plugs delivered with the product are not used.
- The PE point at the AC output port is used only as a PE equipotential bonding point, and cannot substitute for the PE point on the enclosure.
- Ensure that the cable jacket is inside the connector.
- Insert the exposed core wires completely into the holes.
- Connect the AC output power cable securely. Otherwise, the device may fail to operate properly or the AC connector may be damaged.
- Ensure that the cables are not twisted.

NOTE

The cable colors shown in the figures are for reference only. Select an appropriate cable according to the local standards.

----End

5.6 Installing the Backup Load Output Power Cable

Precautions

- An RCD must be installed before the backup load. During off-grid operation, the main circuit breaker does not provide protection. Electric leakage on the loads may result in electric shocks.
- If the power of backup loads exceeds the maximum off-grid power of the inverter, the inverter may be shut down due to overload. In this case, you need to shut down some loads.

Procedure

Step 1 Crimp AC cord end terminals.

NOTE

The AC cord end terminals delivered with the product are mainly used for cables with a cross-sectional area of 16 mm². If cables with a cross-sectional area of less than 16 mm² are used, select AC cord end terminals that meet the requirements.

Figure 5-10 Crimping SmartGuard-63A-S0 AC cord end terminals

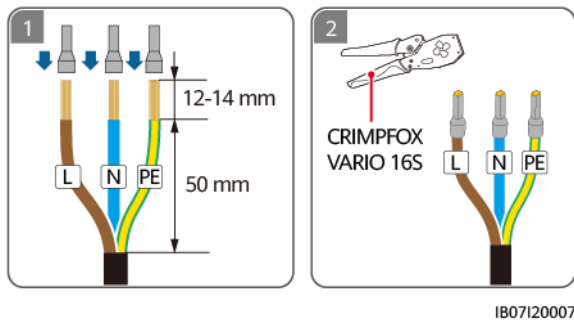
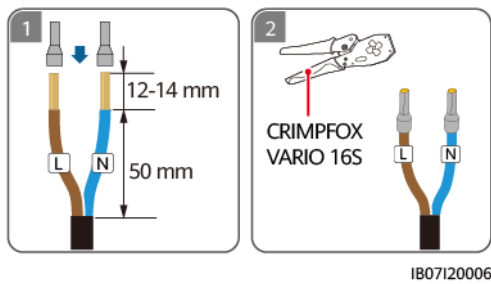
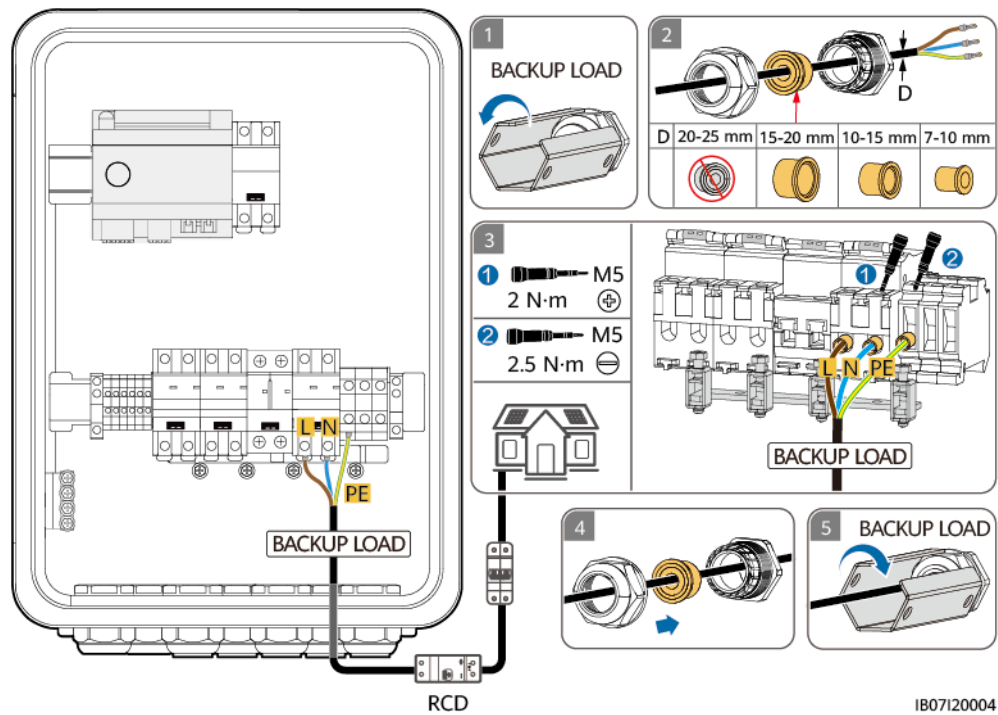

Figure 5-11 Crimping SmartGuard-63A-AUS0 AC cord end terminals



Step 2 Connect the backup load output power cable.

Figure 5-12 Connecting the backup load output power cable



NOTICE

- The two-core cable and three-core cable are connected in the same way. The two-core cable is not connected to the PE.
-  indicates that the three waterproof plugs delivered with the product are not used.
- The PE point at the AC output port is used only as a PE equipotential bonding point, and cannot substitute for the PE point on the enclosure.
- Ensure that the cable jacket is inside the connector.
- Insert the exposed core wires completely into the holes.
- Connect the AC output power cable securely. Otherwise, the device may fail to operate properly or the AC connector may be damaged.
- Ensure that the cables are not twisted.

 **NOTE**

The cable colors shown in the figures are for reference only. Select an appropriate cable according to the local standards.

----End

5.7 Installing the Non-backup Load Output Power Cable

Procedure

- Step 1** Crimp AC cord end terminals. You can crimp AC cord end terminals for two-core or three-core cables.

 **NOTE**

The AC cord end terminals delivered with the product are mainly used for cables with a cross-sectional area of 16 mm². If cables with a cross-sectional area of less than 16 mm² are used, select AC cord end terminals that meet the requirements.

Figure 5-13 Crimping AC cord end terminals

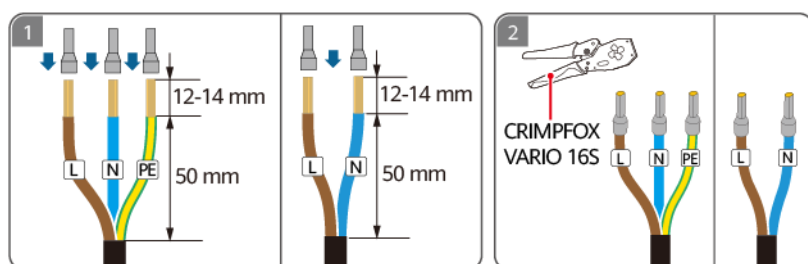

IB07I20001

- Step 2** Connect the non-backup load output power cable.

Figure 5-14 Connecting the non-backup load output power cable (the component in the dashed box is optional)

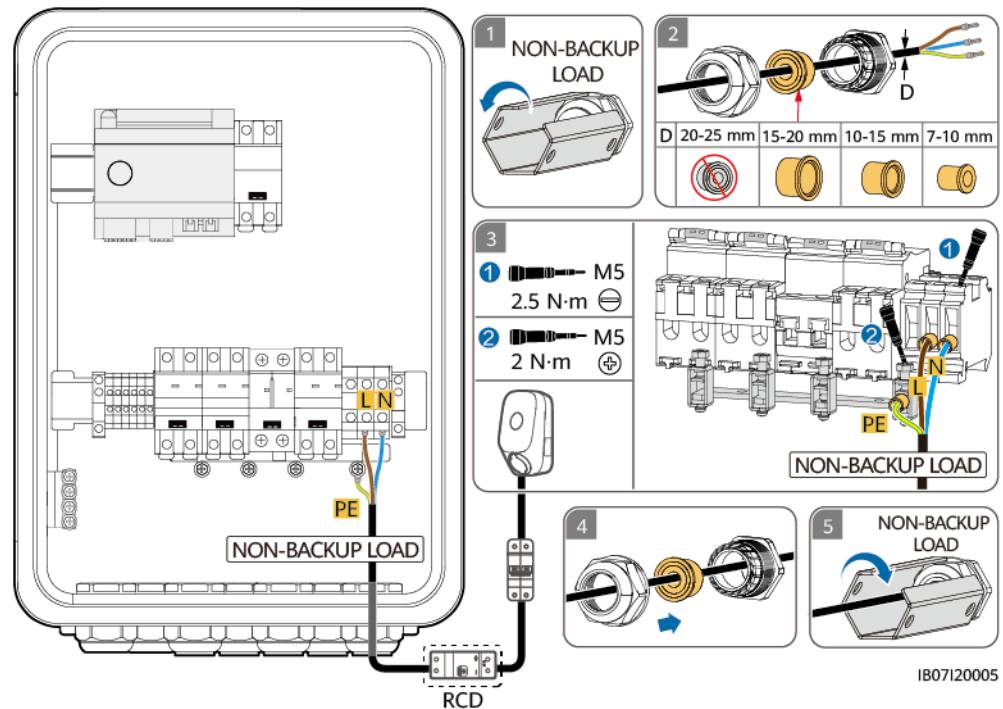

NOTICE

- The two-core cable and three-core cable are connected in the same way. The two-core cable is not connected to the PE.
-  indicates that the three waterproof plugs delivered with the product are not used.
- The PE point at the AC output port is used only as a PE equipotential bonding point, and cannot substitute for the PE point on the enclosure.
- Ensure that the cable jacket is inside the connector.
- Insert the exposed core wires completely into the holes.
- Connect the AC output power cable securely. Otherwise, the device may fail to operate properly or the AC connector may be damaged.
- Ensure that the cables are not twisted.

NOTE

The cable colors shown in the figures are for reference only. Select an appropriate cable according to the local standards.

----End

5.8 Installing EMMA Signal Cables

Precautions

- When laying out signal cables, separate them from power cables and keep them away from strong interference sources to prevent communication interruption.
- Ensure that the protection layer of the signal cable is inside the connector, surplus core wires are cut off from the protection layer, the exposed core wires are inserted completely into the holes, and the cable is connected securely.

Port Definitions

1. FE port definitions

Figure 5-15 Port definitions

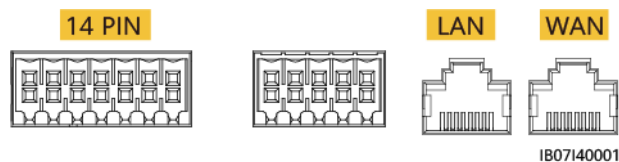

Definition	Function	Description
LAN	RJ45 network port	Connects to a charger.
WAN	RJ45 network port	Connects to a router for the SmartGuard to connect to the FusionSolar SmartPVMS.

2. Definitions of the 14 pins

Figure 5-16 Pin definitions

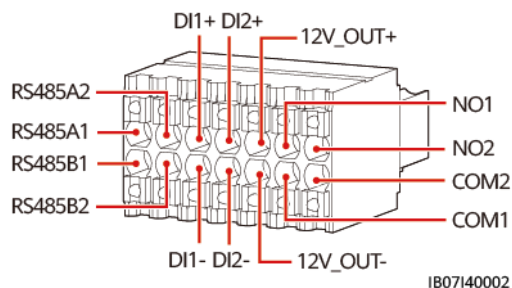

Definition	Function	Description
485A1	RS485B, RS485 differential signal+	Not connected

Definition	Function	Description
485B1	RS485A, RS485 differential signal-	
485A2	RS485B, RS485 differential signal+	Reserved for connecting to third-party devices
485B2	RS485A, RS485 differential signal-	
DI1+	Digital input signal 1+	Reserved for connecting to the mains detection signal port on the ATS
DI1-	Digital input signal 1-	
DI2+	Digital input signal 2+	Reserved for connecting to the genset alarm signal port or ATS genset detection signal port
DI2-	Digital input signal 2-	
12V_OUT+	12 V power output+	Optional. 12 V power output ports of the EMMA, which support 100 mA load, output voltage of 9.5–13.2 V, and 12 V@30 mA capability of driving the external relay coil. The external relay works with NO1 and COM1 to control the SG Ready heat pump.
12V_OUT-	12 V power output-	
NO1	Digital output signal	Optional. SG Ready heat pump control signal ports, which support a maximum of 12 V signal voltage and a maximum contact output capability of 12 V DC@1 A. The NO and COM contacts are normally open and COM is a common point.
COM1	Digital output signal	
NO2	Digital output signal	Reserved
COM2	Digital output signal	

Procedure

Step 1 (Optional) Connect the heat pump control signal cable.

NOTE

When the SG Ready heat pump provides 12 V power supply, the EMMA directly controls the heat pump. When the SG Ready heat pump cannot provide 12 V power supply, the EMMA controls the heat pump through an external relay.

Figure 5-17 Connecting the heat pump control signal cable

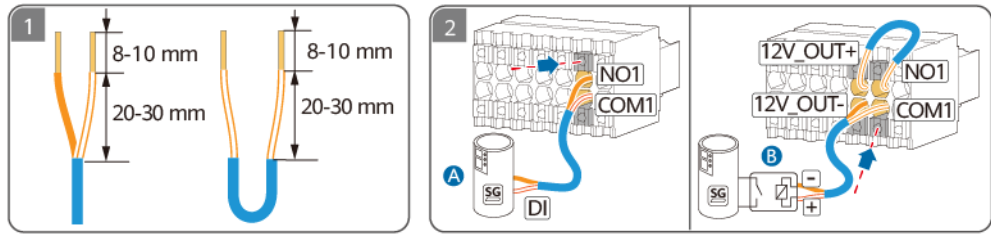

IB07140003

(A) SG Ready heat pump

(B) External relay

Step 2 (Optional) Connect the FE communications cable.

NOTE

- One charger can be connected to the EMMA through the FE port or connected to the router through the FE or WLAN port. Two chargers must be connected to the router only through the FE or WLAN port. Do not connect one charger to the EMMA and the other charger to the router respectively at the same time.
- The EMMA can be connected to the router through the FE or WLAN port. If WLAN is used, the router must be close to the SmartGuard.

Figure 5-18 FE communications cable

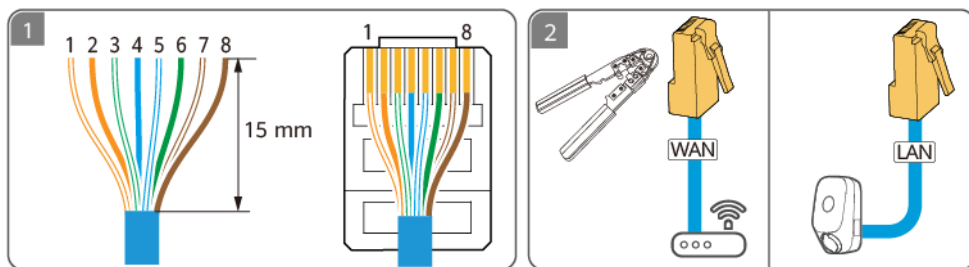

IB07140004

(1) White-and-orange

(2) Orange

(3) White-and-green

(4) Blue

(5) White-and-blue

(6) Green

(7) White-and-brown

(8) Brown

Step 3 Connect the EMMA signal cables.

Figure 5-19 Connecting the EMMA signal cables

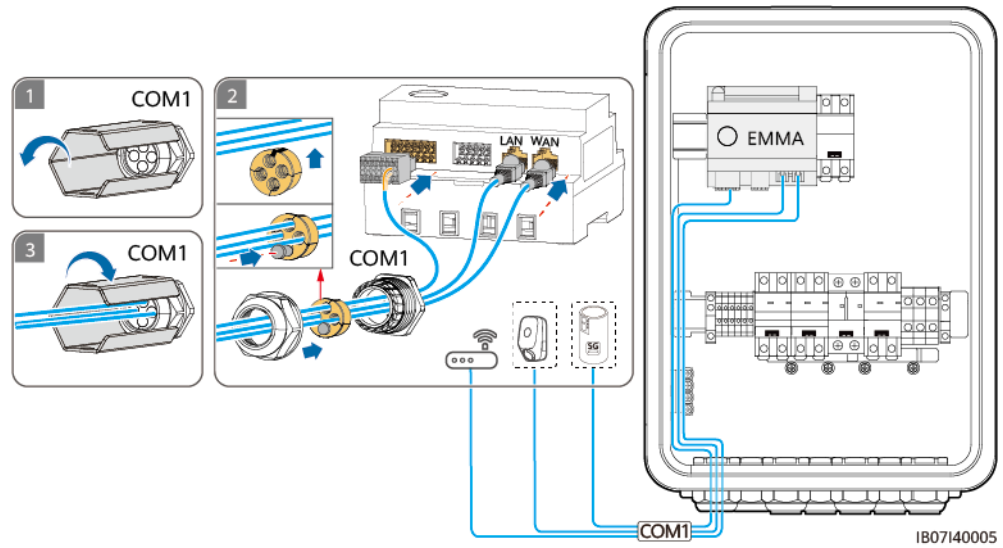

----End

5.9 Installing the SmartGuard Signal Cable

Precautions

When laying out signal cables, separate them from power cables and keep them away from strong interference sources to prevent communication interruption.

Port Definitions

Figure 5-20 Cable connections to the COM ports on the SmartGuard

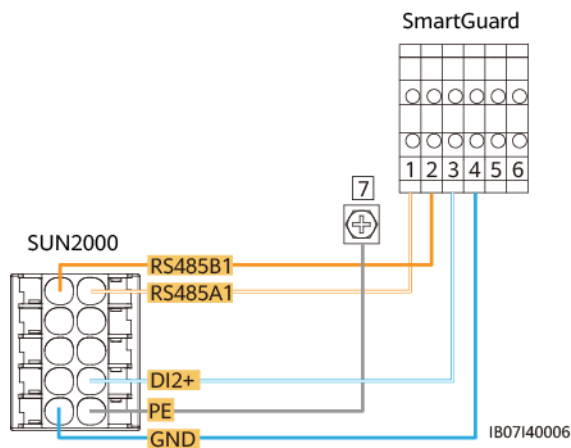

Table 5-4 COM ports on the SmartGuard

No.	Definition	Function	Description
1	COM-1 RS485A1_INV	RS485A, RS485 differential signal+	Connect to the RS485 signal ports of the inverter.
2	COM-2 RS485B1_INV	RS485B, RS485 differential signal-	
3	COM-3 DO_INV	Digital output signal+	Connect to the on/off-grid control signal ports of the inverter.
4	COM-4 DO_INV_CGND	CGND	
5	COM-5 DO_DG	Digital output signal+	Reserved. They can be connected to the genset control signal ports.
6	COM-6 DO_DG_CGND	CGND	
7	PE	Shield layer grounding	Grounds the shield layer of a communications cable.

Procedure

Step 1 Crimp cord end terminals for the signal cable.

Figure 5-21 Crimping cord end terminals for the signal cable

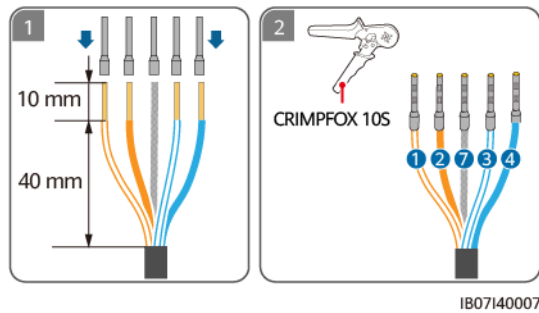

Step 2 Connect the signal cable of the SmartGuard.

Figure 5-22 Connecting the signal cable of the SmartGuard

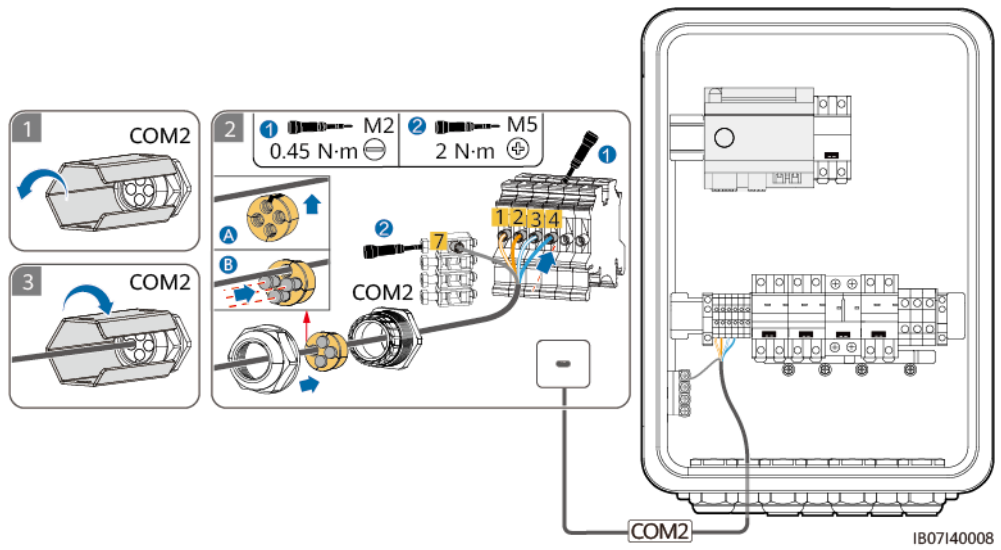

----End

6 System Commissioning

6.1 Check Before Power-On



Check whether the terminals of the SmartGuard are correctly connected according to the document.

Table 6-1 Checklist

No.	Check Item	Acceptance Criteria
1	SmartGuard	The SmartGuard is installed correctly and securely.
3	Cable routing	Cables are routed properly as required by the customer.
4	Cable ties	Cable ties are evenly distributed and no burr exists.
5	Reliable grounding	The PE cable is connected correctly, securely, and reliably.
6	Switches	The switches of the device and all the switches connected to the device are in OFF state.
7	Cable connection	All cables are correctly and securely connected.
8	Unused terminal and port	Unused terminals and ports are locked by waterproof glands.
9	Installation environment	The installation space is proper, and the installation environment is clean and tidy.

6.2 Closing the Maintenance Compartment

NOTE

- Before closing the maintenance compartment, remove tools, unused screws, and residue of cable stripping from the maintenance compartment.
- Keep the delivered keys properly for future use.

Step 1 Install the cover of the maintenance compartment, and tighten the screw on the cover.

Figure 6-1 Closing the cover

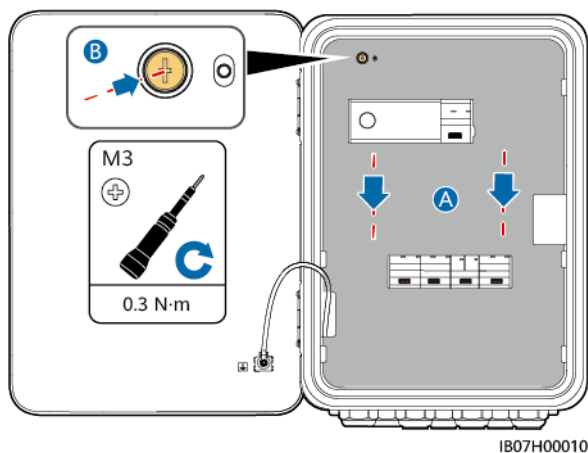

Step 2 Before closing the maintenance compartment door, turn on the three switches shown in the following figure (using the connection to the LCO inverter as an example). During deployment and normal operation, do not operate the bypass switch shown in the figure.

DANGER

- Bypass switch: When the grid is available but the SmartGuard is abnormal and cannot supply power to loads, refer to [7.4 Operations on the Bypass Switch of the SmartGuard](#). Misoperations may cause electric shocks.
 - Currently, only one inverter can be connected. Turn on the switches based on the model of the connected inverter.
-

Figure 6-2 Turning on the switches

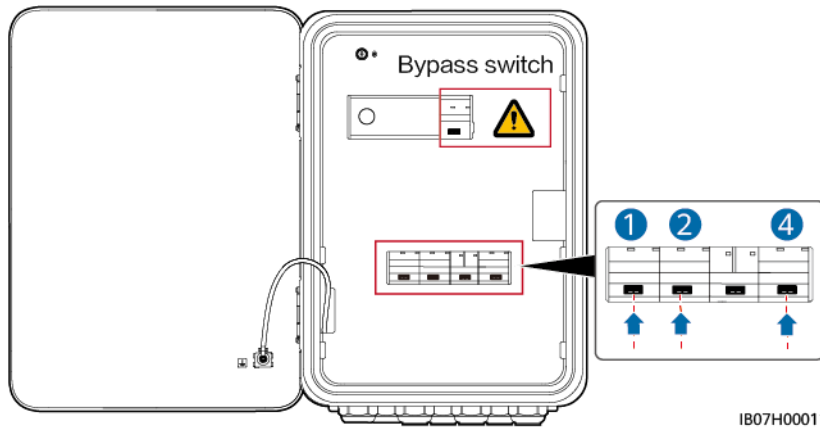

Step 3 Close the maintenance compartment door and lock the SmartGuard.

Figure 6-3 Closing the maintenance compartment door

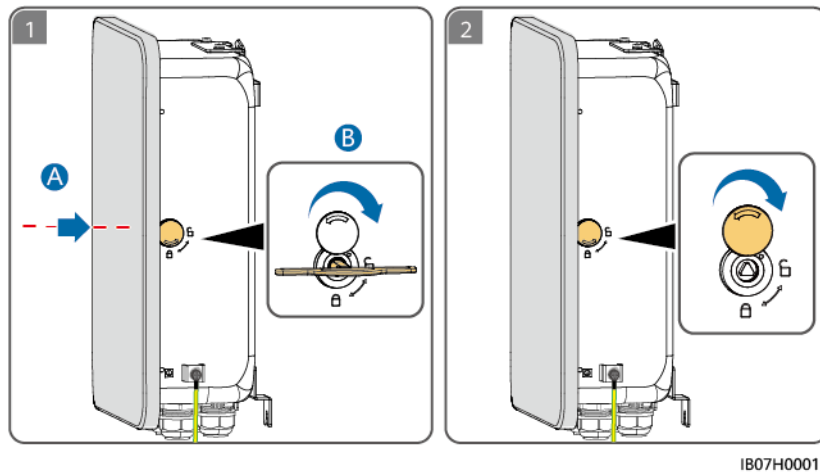

----End

6.3 System Power-On

Precautions

⚠ DANGER

- Wear personal protective equipment and use dedicated insulated tools to avoid electric shocks or short circuits.
-

NOTICE

Before the equipment is put into operation for the first time, ensure that the parameters are set correctly by professional personnel. Incorrect parameter settings may result in noncompliance with local grid connection requirements and affect the normal operations of the equipment.

6.3.1 Powering On the SmartGuard

NOTICE

If a charger is configured, you must power on the system in on-grid mode for commissioning. When the SmartGuard is off-grid, the charger cannot be detected during device commissioning because the charger is not powered on.

Method 1: On-Grid Power-On

- Step 1** Use a multimeter to check whether the AC voltage in the power distribution box is within the allowed range and whether cables are correctly connected.
- Step 2** Turn on the main circuit breaker on the grid side.
- Step 3** Turn on the ESS switch.
1. (Optional) Remove the locking screw for the **DC SWITCH** of the ESS.
 2. Set the **DC SWITCH** of the ESS to **ON**.
- Step 4** Power on the inverter.
1. (Optional) Turn on the DC switch (if any) between the PV strings and the inverter.
 2. (Optional) Remove the locking screw for the **DC SWITCH** of the inverter.
 3. Set the **DC SWITCH** of the inverter to **ON**.
- Step 5** Check that the SmartGuard is running in on-grid mode. Observe the LED indicators on the inverter, ESS, EMMA, and SmartGuard to check the running status.

----End

Method 2: Off-Grid Power-On (with PV Strings)

 **NOTE**

If the PV string is configured with an optimizer, powering on the inverter triggers rapid shutdown. After the off-grid mode is set for the inverter, the inverter automatically switches to off-grid mode.

- Step 1** Turn off the main circuit breaker on the grid side upon a grid failure.
- Step 2** Turn on the ESS switch.
1. (Optional) Remove the locking screw for the **DC SWITCH** of the ESS.

2. Set the **DC SWITCH** of the ESS to **ON**.
3. (Optional) If the PV string is equipped with an optimizer, hold down the black start button for 5s.

Step 3 Power on the inverter.

1. (Optional) Turn on the DC switch (if any) between the PV strings and the inverter.
2. (Optional) Remove the knob locking screw for the **DC SWITCH** of the inverter.
3. Set the **DC SWITCH** of the inverter to **ON**.

Step 4 **Connect to the inverter**. Set the grid code of the inverter and then set off-grid mode of the inverter. For details, see method 2 in [6.4.4 Setting Off-Grid Mode for the Inverter](#).

Step 5 (Optional) **Connect to the inverter**. Upgrade the SUN2000-(2KTL-6KTL)-L1 inverter. Otherwise, the SmartGuard may fail to identify the inverter. For details, see [B Upgrading the Inverter](#).

Step 6 Check that the SmartGuard is running in off-grid mode. Observe the LED indicators on the inverter, ESS, EMMA, and SmartGuard to check the running status.

----End

Method 3: Off-Grid Power-On (Without PV Strings)

NOTE

- The battery SOC is insufficient or the temperature is too low. As a result, the inverter and ESS cannot start.
- If the battery SOC is 0%, the ESS cannot be activated by holding down the black start button. The ESS can be started only after both the DC and AC power supplies to the inverter are connected.

Step 1 Turn off the main circuit breaker on the grid side upon a grid failure.

Step 2 Turn on the ESS switch.

1. (Optional) Remove the locking screw for the **DC SWITCH** of the ESS.
2. Set the **DC SWITCH** of the ESS to **ON**.
3. Press and hold the black start button for 5s.

Step 3 **Connect to the inverter**. Set the grid code of the inverter and then set off-grid mode of the inverter. For details, see method 2 in [6.4.4 Setting Off-Grid Mode for the Inverter](#).

Step 4 (Optional) **Connect to the inverter**. Upgrade the SUN2000-(2KTL-6KTL)-L1 inverter. Otherwise, the SmartGuard may fail to identify the inverter. For details, see [B Upgrading the Inverter](#).

Step 5 Check that the SmartGuard is running in off-grid mode. Observe the LED indicators on the inverter, ESS, EMMA, and SmartGuard to check the running status.

----End

LED Indicators on the EMMA and SmartGuard

Table 6-2 EMMA indicator description





Indicator	Status	Description
Running status indicator 	Off	The system is not powered on.
	Steady green	The system is powered on and running.
Alarm indicator 	Off	No alarm is raised.
	Blinking red slowly (on for 1s and then off for 4s)	The system raises a warning alarm.
	Blinking red fast (on for 0.5s and then off for 0.5s)	The system raises a minor alarm.
	Steady red	A critical or critical alarm is generated.
Communication status indicator 	Off	The IP address of the management system server is not configured. (The indicator is off when the EMMA is not connected to the SmartPVMS.)
	Blinking green slowly (on for 1s and then off for 1s)	The communication with the management system is normal.
	Blinking green fast (on for 0.125s and then off for 0.125s)	The communication with the management system is interrupted.

Table 6-3 Indicators on the SmartGuard

Indicator	Status	Description
	Steady green	The SmartGuard is in on-grid mode.
	Blinking green slowly	(Reserved) The SmartGuard is in DG off-grid mode.
	Steady orange	The SmartGuard is in inverter off-grid mode.
	Steady red	(Device replacement) A hardware alarm is generated on the SmartGuard.

Indicator	Status	Description
	Blinking red slowly	An environment alarm is generated on the SmartGuard.

6.3.2 Powering On Loads

Method 1: On-Grid Power-On

- Step 1** Check that the inverter, ESS, EMMA, and SmartGuard are working properly in on-grid mode.
 - Step 2** After checking that the residential load circuit is not short-circuited, turn on the backup load and non-backup load switches.
 - Step 3** (Optional) Set charger route parameters.
- End

Method 2: Off-Grid Power-On (with PV Strings)

- Step 1** Check that the inverter, ESS, EMMA, and SmartGuard are working properly in off-grid mode.
 - Step 2** Check that the residential backup load power does not exceed the off-grid operating power of the inverter.
 - Step 3** After checking that the residential load circuit is not short-circuited, turn on the backup load and non-backup load switches.
- End

Method 3: Off-Grid Power-On (Without PV Strings)

- Step 1** Check that the inverter, ESS, EMMA, and SmartGuard are working properly in off-grid mode.
 - Step 2** Check that the residential backup load power does not exceed the off-grid operating power of the inverter.
 - Step 3** (Optional) Turn off all backup load switches except the router switch to ensure that the battery SOC is sufficient for the device commissioning.
 - Step 4** After checking that the residential load circuit is not short-circuited, turn on the backup load and non-backup load switches.
- End

6.4 Device Commissioning

6.4.1 Deploying a New Plant

Deploying a New Plant



NOTE

- For details about new plant deployment and existing plant reconstruction, see [FusionSolar App Quick Guide \(EMMA\)](#) or scan the QR code.
- In the existing plant reconstruction scenario, the SmartGuard and Dongle cannot be used at the same time. You need to remove the Dongle from the inverter. The SmartGuard has a built-in meter. The original meter in the plant is removed.
- For details about how to set ESS parameters, inverter parameters, and optimizer layout, see *Residential Smart PV Solution User Manual*.

Connection Test

Connection Test is supported in quick settings. You can perform this step to check whether the cable connections are correct, avoiding site visits for rectification.

Tap **Connection Test** and wait until the test is complete. If the test fails, rectify the fault in a timely manner.

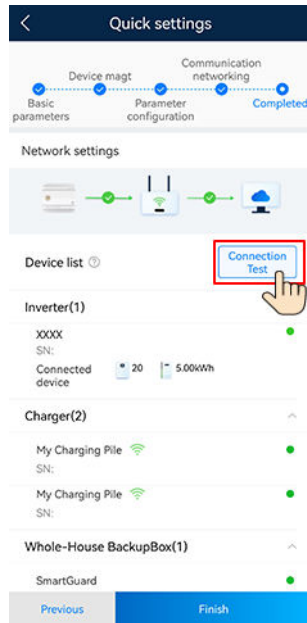

6.4.2 Commissioning Functions

Commission the following functions as needed:

Table 6-4 Commissioning functions

Function	Scenario Description	Procedure
Adding Intelligent Electrical Equipment	Intelligent electrical equipment (such as SG Ready heat pumps and electrical devices controlled by smart switches) in your home can be added to the FusionSolar app for management.	For details, see FusionSolar App Quick Guide (EMMA) , or scan the QR code to download the quick guide.
Limited Feed-in	If surplus PV power is fed into the grid, the parameter of limited feed-in power can be set to ensure that the feed-in power is within the range specified by the grid company.	
Scheduling via DI Port	Applies to scenarios where the grid company performs remote scheduling through dedicated ripple control receivers. The grid company remotely delivers a scheduling command (%) to the plant with a wireless transmitting apparatus. Then, the wireless receiving apparatus receives the scheduling command and converts it into a DI signal. The EMMA controls the inverter to output the corresponding power.	

Function	Scenario Description	Procedure
Peak Shaving	Applies to areas that have peak demand charges. The capacity control function allows you to lower the peak power drawn from grid in maximum self-consumption or TOU mode during peak hours, reducing electricity fees.	
Setting External WLAN Antenna Parameters	By default, the EMMA has a built-in WLAN antenna. If the signal quality of the power distribution box is poor, install an external antenna to enhance WLAN signals. If an external antenna is used, set the antenna in the built-in WLAN parameters to an external antenna.	

For details about app operations, see [FusionSolar App User Manual](#).

6.4.3 Setting Seamless Handover

Connect to the EMMA by referring to [C Connecting the EMMA on the App](#), choose **Set > Whole-House Power Backup Settings**, and enable **Seamless switchover**.

Table 6-5 Seamless handover description

Parameter	Value Range	Description
Seamless switchover	Disabled (default)	<ul style="list-style-type: none"> When the grid fails, loads will be powered off for a short while during on/off-grid switchover. The SmartGuard slowly switches to off-grid mode.
	Enabled	<ul style="list-style-type: none"> When the grid fails or is abnormal, the system switches to off-grid mode within 20 ms. The low voltage ride-through (LVRT) function does not take effect.

Figure 6-4 Setting seamless switchover

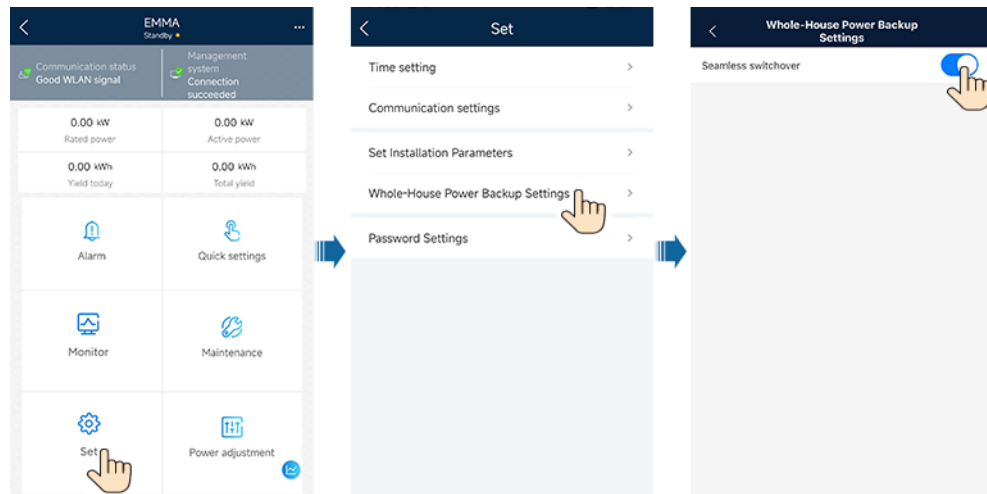

6.4.4 Setting Off-Grid Mode for the Inverter

After the off-grid mode is set, the inverter supports off-grid operation.

Method 1: Setting Off-Grid Mode for the Inverter Using the SmartGuard

Connect to the EMMA by referring to [C Connecting the EMMA on the App](#), choose **Monitor** > **SUN2000**, tap **Set**, and enable **Off-grid mode**.

Figure 6-5 Setting off-grid mode

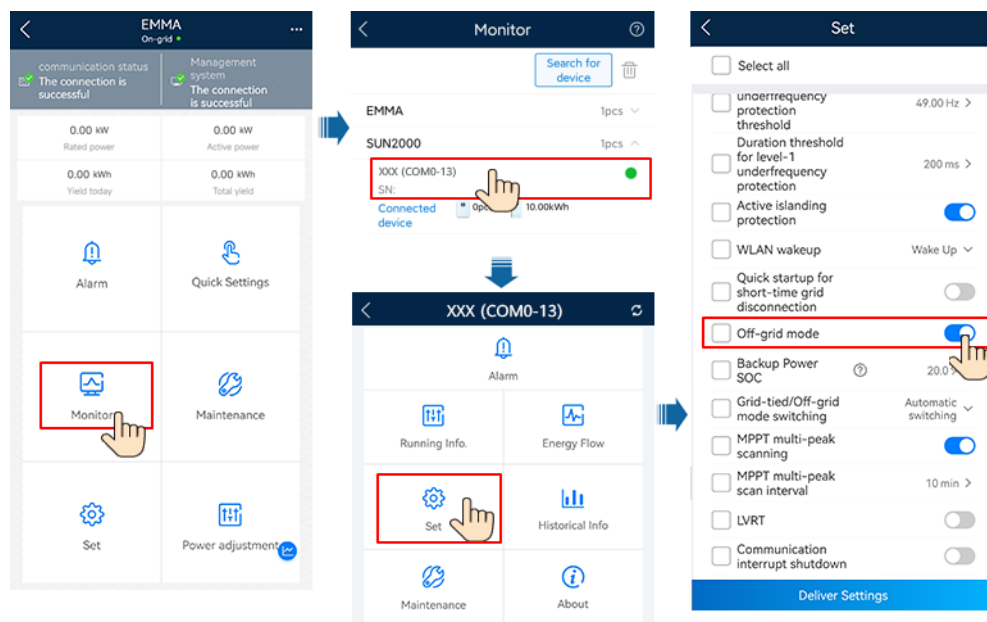

Method 2: Directly Setting Off-Grid Mode for the Inverter

Connect to the inverter by referring to [A Connecting the Inverter on the App](#). On the home screen, choose **Set** > **Feature parameters** and enable **Off-grid mode**.

Figure 6-6 Setting off-grid mode

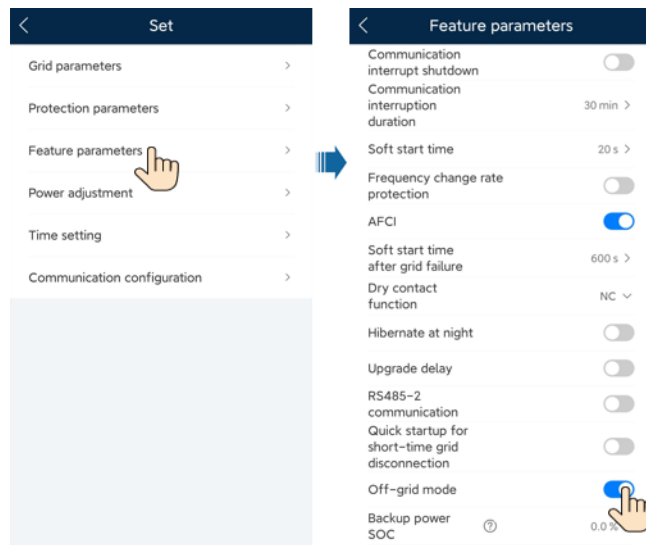

Table 6-6 On/Off-grid parameter settings

Parameter	Description	Value Range
Off-grid mode	If this parameter is enabled, the inverter switches to off-grid mode through the SmartGuard when the grid fails.	<ul style="list-style-type: none"> Enabled Disabled
Backup power SOC	Set the backup power SOC. In on-grid mode, the ESS does not discharge when it is discharged to the backup power SOC. When the grid fails, loads are powered in backup mode.	[0, 50%]

6.5 Verifying On/Off-Grid Switchover

After the system is powered on for the first time, verify the on/off-grid switchover.

Method 1: On-Grid Operation Verification

- Step 1** Check that the grid is available and the SmartGuard is running in on-grid mode.
- Step 2** (Optional) Enable **Off-grid mode** for the inverter. For details, see method 2 in [6.4.4 Setting Off-Grid Mode for the Inverter](#).
- Step 3** Check that the residential backup load power does not exceed the off-grid operating power of the inverter.
- Step 4** Turn off the main circuit breaker on the grid side and check whether the off-grid operation is normal and whether the indicator on the SmartGuard is steady orange.
- Step 5** Turn on the main circuit breaker on the grid side. The indicator on the SmartGuard is steady green, indicating that the inverter is connected to the grid.

Step 6 (Optional) Use the owner account to set smart appliances. For details, see [D Using Smart Appliances \(Owner\)](#).

----End

Method 2: Off-Grid Operation Verification

Step 1 Check that the indicator on the SmartGuard is steady orange because the SmartGuard is off-grid due to a grid failure.

Step 2 After the grid recovers, turn on the main circuit breaker on the grid side and check whether the on-grid operation is normal and whether the indicator on the SmartGuard is steady green.

Step 3 (Optional) Use the owner account to set smart appliances. For details, see [D Using Smart Appliances \(Owner\)](#).

----End

7 System Maintenance

7.1 System Power-Off

Precautions

 **WARNING**

- Before opening the maintenance compartment door, turn off the main circuit breaker on the grid side, and then turn off the switches for residential backup loads and non-backup loads. Shut down the inverter, and turn off the DC switches of the inverter and ESS.
 - Only authorized personnel can open the maintenance compartment cover to perform electrical connections.
 - Before opening the maintenance compartment cover, turn off the backup load circuit breaker, grid AC circuit breaker, and two inverter AC circuit breakers inside the SmartGuard.
 - After the SmartGuard powers off, the remaining electricity and heat may still cause electric shocks and burns. Therefore, wait for at least 5 minutes and wear insulated gloves before working on the SmartGuard.
-

Procedure

Step 1 Turn off the main circuit breaker on the grid side.

Step 2 Power off the inverter.

1. Send a shutdown command to the inverter on the app.
2. Set the **DC SWITCH** of the inverter to **OFF**.
3. (Optional) Install the locking screw for the **DC SWITCH**.
4. (Optional) Turn off the DC switch between the inverter and PV strings.

Step 3 Shut down the ESS.

1. Set the **DC SWITCH** of the ESS to **OFF**.
2. (Optional) Install the locking screw for the **DC SWITCH** of the ESS.

Step 4 Turn off the switches for residential backup loads and non-backup loads.

----End

7.2 Routine Maintenance

To ensure that the system operates properly for a long term, you are advised to perform routine maintenance as described in this section.

 **CAUTION**

Before cleaning the system, connecting cables, and checking the grounding reliability, power off the system.

Table 7-1 Maintenance checklist

Check Item	Check Method	Maintenance Interval
System cleanliness	Check periodically that the SmartGuard is free from obstacles and dust.	Once every 6 to 12 months
System status	<ul style="list-style-type: none"> • Check that the SmartGuard is not damaged or deformed. • Check that the SmartGuard does not generate abnormal sound when it is in operation. • Check whether SmartGuard parameters are correctly set when the device is running. 	Once every six months
Electrical connections	<ul style="list-style-type: none"> • Check whether cables are securely connected. • Check whether cables are damaged, especially whether the cable sheath that contacts a metal surface is damaged. • Unused AC input ports, COM ports, and waterproof covers on the SmartGuard are locked. 	6 months after the first commissioning and once every 6 to 12 months after that
Grounding reliability	Check whether the PE cable is securely connected.	6 months after the first commissioning and once every 6 to 12 months after that

7.3 Troubleshooting

Alarm severities are defined as follows:

- Major: The SmartGuard shuts down or some of its functions are abnormal due to a fault.
- Minor: Some components of the SmartGuard are faulty but the system can still operate.
- Warning: The SmartGuard functions normally, but its output power decreases due to external factors.

SmartGuard Alarms

Table 7-2 Common alarms and troubleshooting measures

ID	Alarm	Severity	Possible Cause	Suggestions
4201	Incorrect Wiring	Major	Cause ID = 1 1. Inverter cables are loose or connected to the wrong ports. 2. Power backup cables are connected to the wrong ports.	1. Power off the SmartGuard. After 5 minutes, check whether the cable connection to the inverter or the backup load is normal. If the cable connection is abnormal, rectify the fault. 2. You are advised to check all other cables of the SmartGuard. If any cable connection is abnormal, correct it. 3. Power on the SmartGuard. If the fault persists 5 minutes after the device restarts, contact your vendor or technical support.
			Cause ID = 2 1. Mains cables are loose or connected to the wrong ports. 2. Non-power-backup cables are connected to the wrong ports.	
4202	On-/Off-Grid Switching Signal Abnormal	Major	Cause ID = 1 The cable connection between the SmartGuard and inverter is abnormal.	1. Check the DO cable between the SmartGuard and inverter. If the cable is loose or disconnected, securely connect it. 2. If the alarm is not automatically cleared after the cable connection fault is rectified, you need to manually clear the alarm on the app.

ID	Alarm	Severity	Possible Cause	Suggestions
4203	Incorrect Connection of Live and Neutral Wires	Warning	Cause ID = 1 The live and neutral wires of mains power are incorrectly connected.	<ol style="list-style-type: none"> 1. Power off the SmartGuard. After 5 minutes, check and correct the live and neutral wire connection. 2. Power on the SmartGuard. If the fault persists 5 minutes after the device restarts, contact your vendor or technical support.
4204	Device Fault	Major	A major fault has occurred on the internal circuit of the device. Cause ID = 1-4 <ul style="list-style-type: none"> • 1: The internal communication is faulty. • 2: The auxiliary power supply is abnormal. • 3: The magnetic latching relay is abnormal. • 4: The contactor is abnormal. 	<ol style="list-style-type: none"> 1. Power off the SmartGuard for 5 minutes. 2. Power on the SmartGuard. If the fault persists 5 minutes after the device restarts, turn on the bypass switch to supply power to loads and contact your vendor or technical support.
			Cause ID = 5 The N-PE relay is short-circuited.	<ol style="list-style-type: none"> 1. Power off the SmartGuard for 5 minutes. 2. Power on the SmartGuard. If the fault persists 5 minutes after the device restarts, contact your vendor or technical support.

ID	Alarm	Severity	Possible Cause	Suggestions
			<p>A major fault has occurred on the internal circuit of the device.</p> <p>Cause ID = 6-10</p> <ul style="list-style-type: none"> ● 6: EEPROM read/write failed. ● 7: The sampling circuit is faulty. ● 8: Temperature detection of the magnetic latching relay failed. ● 9: Temperature detection of the N-PE relay failed. ● 10: Compartment temperature detection failed. 	<ol style="list-style-type: none"> 1. Power off the SmartGuard for 5 minutes. 2. Power on the SmartGuard. If the fault persists 5 minutes after the device restarts, turn on the bypass switch to supply power to loads and contact your vendor or technical support.
			<p>Cause ID = 11</p> <ol style="list-style-type: none"> 1. A major fault has occurred on the internal circuit of the device. 2. The primary controller failed. 	
			<p>A major fault has occurred on the internal circuit of the device.</p> <p>Cause ID = 12 or 13</p> <ul style="list-style-type: none"> ● 12: The main and auxiliary sampling voltages of the grid are inconsistent. ● 13: The main and auxiliary N-PE sampling voltages are inconsistent. 	
			<p>Cause ID = 14</p> <p>The grid voltage sampling circuit or inverter voltage sampling circuit is severely faulty.</p>	

ID	Alarm	Severity	Possible Cause	Suggestions
4205	Update Failure or Version Mismatch	Minor	The update failed. Cause ID = 1, 2, 3 <ul style="list-style-type: none"> ● 1: The update failed. ● 2: The monitoring software version does not match the power software version. ● 3: The software and hardware versions do not match. 	<ol style="list-style-type: none"> 1. Perform the update again. 2. If the update fails for multiple times, you are advised to turn on the bypass switch to supply power to loads and contact your vendor or technical support.
4206	Overtemperature	Minor	<ol style="list-style-type: none"> 1. The device is covered by foreign objects. 2. The ambient temperature is high. 3. The load is excessive. 4. An exception occurred on the internal circuit of the device. Cause ID = 1, 2, 3 <ul style="list-style-type: none"> ● 1: Overtemperature occurs on the magnetic latching relay. ● 2: Overtemperature occurs on the N-PE relay. ● 3: Overtemperature occurs on the compartment. 	<ol style="list-style-type: none"> 1. Check whether the device is covered by foreign objects. If yes, clean the foreign objects. 2. Check whether the ambient temperature exceeds the allowed range. If yes, adjust the ambient temperature. 3. You are advised to shut down some high-power loads. 4. If the fault persists, contact your vendor or technical support.
4207	Abnormal Grounding	Warning	Cause ID = 1 The enclosure ground cable is not securely connected.	<ol style="list-style-type: none"> 1. Power off the SmartGuard. After 5 minutes, check whether the neutral wire is loose or broken. If yes, rectify the fault. 2. Power on the SmartGuard. If the fault persists after the device restarts for 5 minutes, contact your vendor or technical support.

ID	Alarm	Severity	Possible Cause	Suggestions
			Cause ID = 2 1. The ground cable of the neutral wire is not securely connected. 2. An exception occurred on the internal circuit of the device.	
4208	Grid Overvoltage	Major	Cause ID = 1 The grid voltage is higher than the withstand voltage of the device.	1. Check whether the line voltage of the three-phase power grid is incorrectly connected to the system. If yes, connect the phase voltage to the system. 2. If the alarm occurs occasionally, the power grid may be abnormal temporarily. The device automatically recovers after detecting that the power grid becomes normal. 3. Check whether the peak voltage of the power grid is too high. If the fault occurs frequently and persists for a long time, contact the local power operator.
4209	Bypass Switch Turned On	Major	Cause ID = 1 1. The bypass switch is on. 2. The bypass switch is short-circuited on both sides due to abnormal cable connections.	1. Power off the SmartGuard and turn off the bypass switch. After 5 minutes, check whether the system cable connection is normal. If the cable connection is abnormal, rectify the fault. 2. Power on the SmartGuard. If the fault persists and no power is supplied to loads 5 minutes after the device restarts, turn on the bypass switch to supply power to loads and contact your vendor or technical support.
4211	BackupBox Overload	Major	Cause ID = 1 The power of appliances is too high.	Check whether high-power appliances are started. If yes, shut them down.

ID	Alarm	Severity	Possible Cause	Suggestions
4212	Communication Failure	Major	Cause ID = 1 The communication between the SmartGuard and the EMMA is abnormal.	<ol style="list-style-type: none"> 1. Power off the SmartGuard. After 5 minutes, check whether the RS485 communications cable between the SmartGuard and the inverter is properly connected. If not, rectify the fault. 2. Open the front cover of the SmartGuard and check whether the RS485 A1 and RS485 B1 terminals on the 10-pin terminal of the EMMA are correctly connected. If not, connect them correctly. 3. Open the front cover of the SmartGuard and check whether the 12V_OUT+ and 12V_OUT- power supply harness of the 14-pin terminal on the EMMA is short-circuited. If a short circuit occurs, rectify the fault. 4. Power on the SmartGuard. If the fault persists 5 minutes after the device restarts, contact your vendor or technical support.

Alarms Related to the Inverter and SmartGuard

Table 7-3 Common alarms and troubleshooting measures

ID	Alarm	Severity	Possible Cause	Suggestions
2082	Grid-tied/Off-grid Controller Abnormal	Major	<p>Cause ID = 1</p> <p>The communication between the inverter and the grid-tied/off-grid controller is abnormal.</p>	<ol style="list-style-type: none"> 1. Power off the SmartGuard. After 5 minutes, check whether the RS485 communications cable between the SmartGuard and the inverter is properly connected. If not, rectify the fault. 2. Open the front cover of the SmartGuard and check whether the RS485 A1 and RS485 B1 terminals on the 10-pin terminal of the EMMA are correctly connected. If not, connect them correctly. 3. Open the front cover of the SmartGuard and check whether the 12V_OUT+ and 12V_OUT- power supply harness of the 14-pin terminal on the EMMA is short-circuited. 4. Power on the SmartGuard. If the fault persists 5 minutes after the device restarts, contact your vendor or technical support.
			<p>Cause ID = 2</p> <p>The circuit of the grid-tied/off-grid controller is faulty.</p>	<ol style="list-style-type: none"> 1. Power off the SmartGuard. After 5 minutes, check whether the DO/DI cable between the SmartGuard and the inverter is properly connected. If not, rectify the fault. 2. Check whether the power cable between the SmartGuard and the inverter is properly connected. If not, connect the power cable properly. 3. Power on the SmartGuard. If the fault persists 5 minutes after the device restarts, contact your vendor or technical support.

7.4 Operations on the Bypass Switch of the SmartGuard

Precautions

 DANGER

- Do not operate the bypass switch during site deployment or normal use.
 - When the grid is available but the SmartGuard is abnormal and cannot supply power to loads, check and clear the SmartGuard alarm. If the fault persists, consult the customer service personnel and then operate the bypass switch. Misoperations may cause electric shocks.
-

 WARNING

- Before operating the bypass switch, power off the SmartGuard.
 - Before opening the maintenance compartment door, turn off the main circuit breaker on the grid side, and then turn off the switches for residential backup loads and non-backup loads. Shut down the inverter, and turn off the DC switches of the inverter and ESS.
 - Only authorized personnel can open the maintenance compartment cover to perform electrical connections.
 - After the SmartGuard powers off, the remaining electricity and heat may still cause electric shocks and burns. Therefore, wait for at least 5 minutes and wear insulated gloves before working on the SmartGuard.
-

Procedure

- Step 1** Check that the grid is available and the SmartGuard is abnormal and cannot supply power to loads.
- Step 2** Power off the system. For details, see [7.1 System Power-Off](#).
- Step 3** Perform operations on the SmartGuard bypass switch.
 1. Open the maintenance compartment door and turn off the four switches shown in the figure.

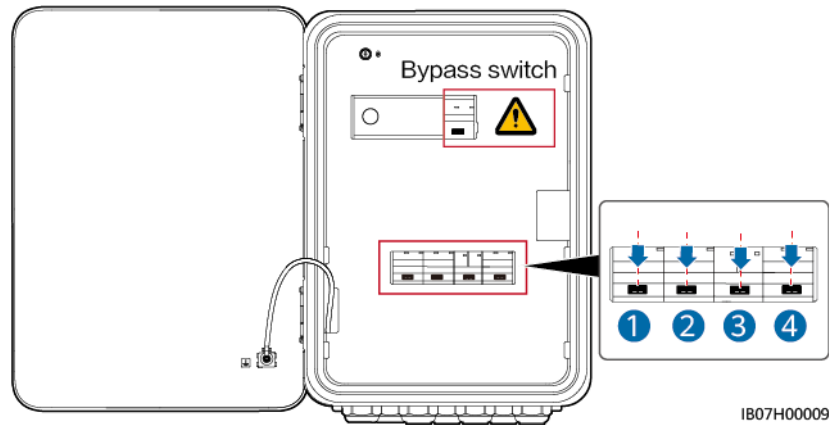

2. Remove the bypass switch latch, turn on the bypass switch, and then turn on switches ① and ④ shown in the figure.

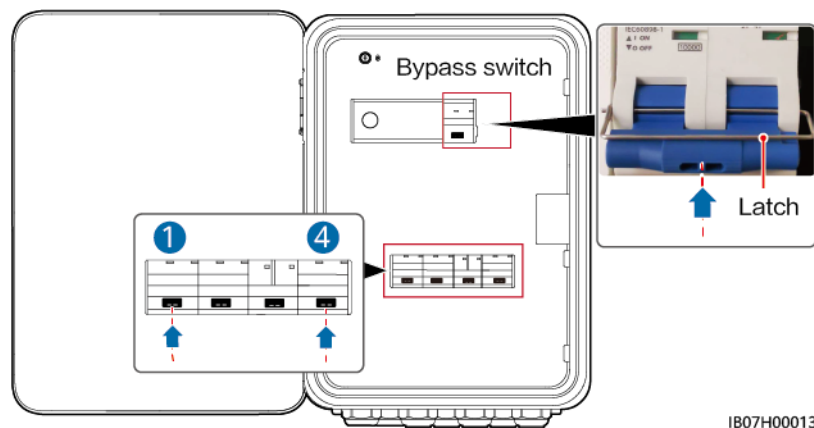

3. Close the maintenance compartment door.

Step 4 Turn on the main circuit breaker on the grid side. Turn on the switches for residential backup loads and non-backup loads.

----End

7.5 Replacing the SmartGuard

Precautions

⚠ DANGER

- Wear personal protective equipment and use dedicated insulated tools to avoid electric shocks or short circuits.
-

 **WARNING**

- Before performing maintenance, power off the equipment, follow the instructions on the delayed discharge label, and wait for a period of time as specified to ensure that the equipment is not energized.
 - Before opening the maintenance compartment door, turn off the main circuit breaker on the grid side, and then turn off the switches for residential backup loads and non-backup loads. Shut down the inverter, and turn off the DC switches of the inverter and ESS.
 - Only authorized personnel can open the maintenance compartment cover to perform electrical connections.
 - Before opening the maintenance compartment cover, turn off the backup load circuit breaker, grid AC circuit breaker, and two inverter AC circuit breakers inside the SmartGuard.
 - After the SmartGuard powers off, the remaining electricity and heat may still cause electric shocks and burns. Therefore, wait for at least 5 minutes and wear insulated gloves before working on the SmartGuard.
-

Procedure

- Step 1** Power off the system. For details, see [7.1 System Power-Off](#).
- Step 2** Open the maintenance compartment door, and turn off the backup load circuit breaker, grid AC circuit breaker, and two inverter AC circuit breakers inside the SmartGuard.
- Step 3** Remove all electrical connections from the SmartGuard.
- Step 4** Unscrew the SmartGuard from the mounting bracket.
- Step 5** Install a new SmartGuard. For details, see [4 System Installation](#).
- Step 6** Perform electrical connections. For details, see [5 Electrical Connections](#).
- Step 7** Commission the SmartGuard. For details, see [6 System Commissioning](#).
- End

8 Technical Specifications

Technical Specifications

Item	SmartGuard-63A-S0	SmartGuard-63A-AUS0
Inverter port current	60 A	
Current of the backup power port	63 A	
Current of the non-backup power port	63 A	
Grid port current	63 A	
Rated AC voltage	220 V/230 V/240 V, L/N+PE	
Startup mode	Started on the grid side or on the inverter side	
Working mode	On-grid or off-grid	
LVRT	Supported	
On/Off-grid switchover time (fast switchover)	20 ms	
Home energy management system (EMMA)	Available	
Bypass mode	Manual	

Display and Communication

Item	SmartGuard-63A-S0	SmartGuard-63A-AUS0
Display	LED indicators; WLAN+App	
RS485	Supported	

Item	SmartGuard-63A-S0	SmartGuard-63A-AUS0
Built-in WiFi	Supported	

General Specifications

Item	SmartGuard-63A-S0	SmartGuard-63A-AUS0
Weight	≤ 14 kg	
Dimensions (W x H x D)	485 mm x 355 mm x 150 mm	
Noise	29 dB	
Cooling mode	Free cooling	
Maximum operating altitude	4000 m (derated when the altitude is greater than 2000 m)	
Operating temperature	-25°C to +50°C	
IP rating	IP55	

NOTE

- On-grid mode: The ambient temperature ranges from -25°C to +30°C, and the long-term steady-state current is not derated. When the temperature ranges from 30°C to 40°C, the current is linearly derated from 63 A to 50 A. When the temperature ranges from 40°C to 50°C, the current is linearly derated from 50 A to 40 A.
- Off-grid mode: The ambient temperature ranges from -25°C to +40°C, and the long-term steady-state current is not derated. When the temperature ranges from 40°C to 50°C, the current is linearly derated from 54.5 A to 50 A.

A Connecting the Inverter on the App

Step 1 Access the **Commission Device** screen.

Figure A-1 Method 1: before login (not connected to the Internet)

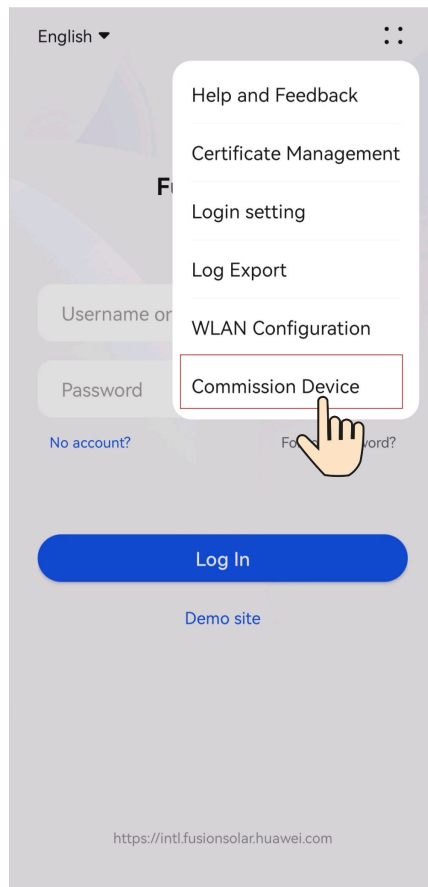
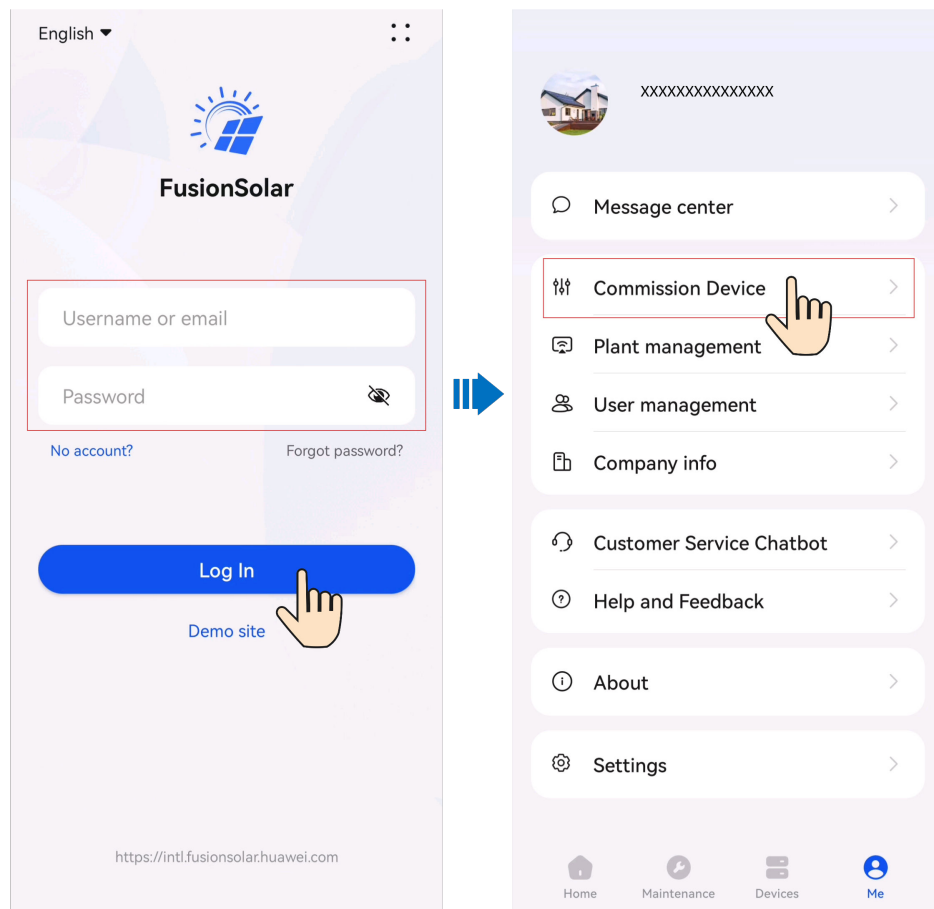
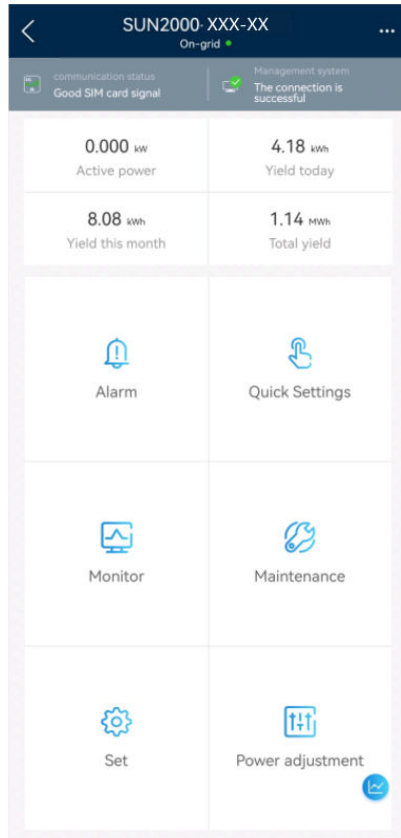

Figure A-2 Method 2: after login (connected to the Internet)



Step 2 Connect to the inverter WLAN, log in as **Installer**, and access the device commissioning screen.



NOTICE

- When directly connecting your phone to a device, ensure that your phone is within the WLAN coverage of the device.
- When connecting the device to the router over WLAN, ensure that the device is within the WLAN coverage of the router and the signal is stable and good.
- The router supports WLAN (IEEE 802.11 b/g/n, 2.4 GHz) and the WLAN signal reaches the inverter.
- The WPA, WPA2, or WPA/WPA2 encryption mode is recommended for routers. The Enterprise mode is not supported (such as airport WLAN and other public hotspots that require authentication). WEP and WPA TKIP are not recommended because they have serious security vulnerabilities. If the access fails in WEP mode, log in to the router and change the encryption mode of the router to WPA2 or WPA/WPA2.

 **NOTE**

- The last six digits of the product WLAN name are the same as the last six digits of the product SN.
- For the first connection, log in with the initial password. You can obtain the initial password from the label on the device.
- To ensure account security, protect the password by changing it periodically, and keep it secure. Your password might be stolen or cracked if it is left unchanged for extended periods. If a password is lost, devices cannot be accessed. In these cases, the Company shall not be liable for any loss.
- If the login screen is not displayed after you scan the QR code, check whether your phone is correctly connected to the device WLAN. If not, manually select and connect to the WLAN.
- If the **This WLAN network has no Internet access. Connect anyway?** message is displayed when you connect to the built-in WLAN, tap **CONNECT**. Otherwise, you cannot log in to the system. The actual UI and messages may vary with mobile phones.

----End

B Upgrading the Inverter

NOTE

If the phone is not connected to a network, prepare the upgrade package before upgrading the inverter.

Connect to the inverter, choose **Maintenance** > **Upgrade** on the home screen, and select the corresponding inverter version.

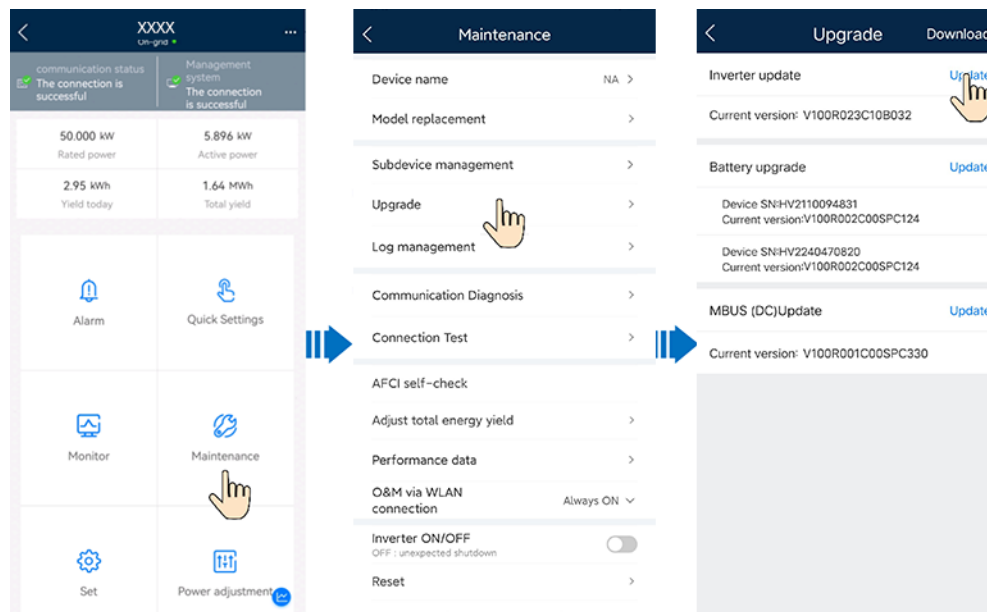

C Connecting the EMMA on the App

Step 1 Access the **Commission Device** screen.

Figure C-1 Method 1: before login (not connected to the Internet)

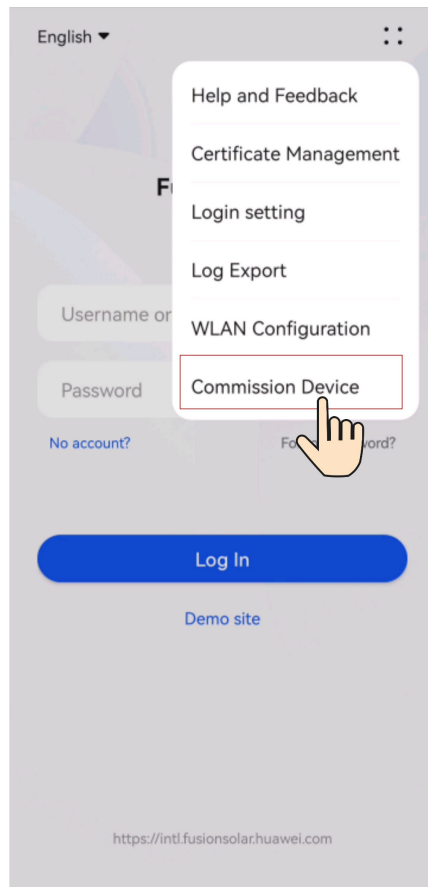
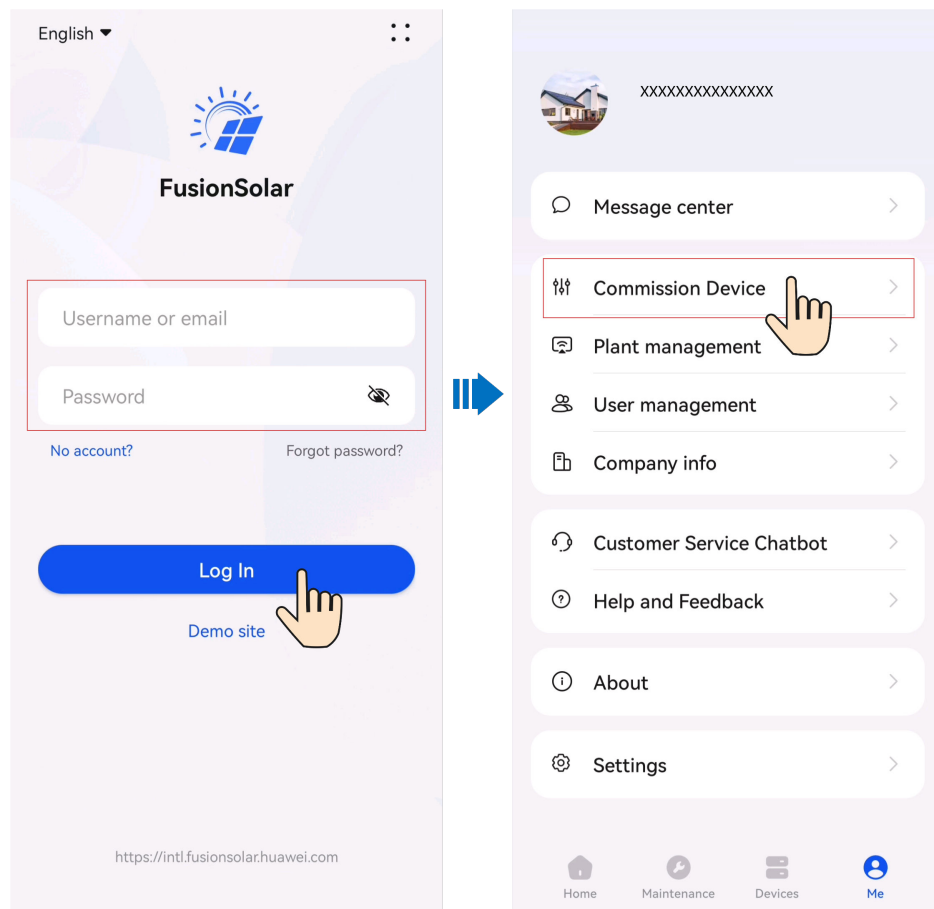
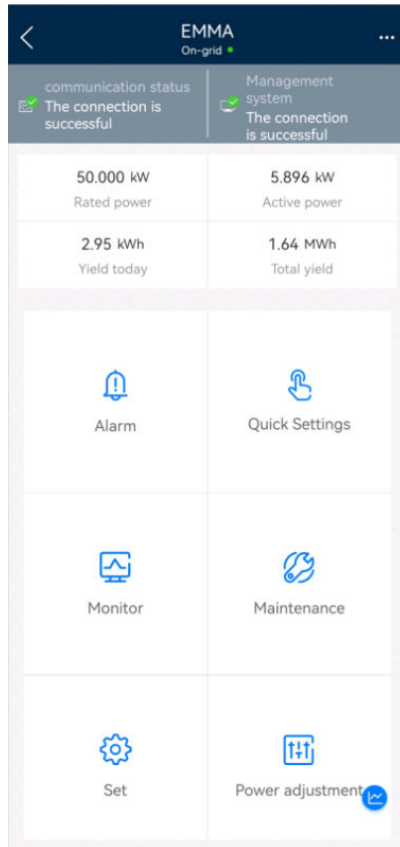

Figure C-2 Method 2: after login (connected to the Internet)



Step 2 Connect to the EMMA WLAN, log in as **Installer**, and access the device commissioning screen.



NOTICE

- When directly connecting your phone to a device, ensure that your phone is within the WLAN coverage of the device.
- When connecting the device to the router over WLAN, ensure that the device is within the WLAN coverage of the router and the signal is stable and good.
- The router supports WLAN (IEEE 802.11 b/g/n, 2.4 GHz) and the WLAN signal reaches the inverter.
- The WPA, WPA2, or WPA/WPA2 encryption mode is recommended for routers. The Enterprise mode is not supported (such as airport WLAN and other public hotspots that require authentication). WEP and WPA TKIP are not recommended because they have serious security vulnerabilities. If the access fails in WEP mode, log in to the router and change the encryption mode of the router to WPA2 or WPA/WPA2.

 **NOTE**

- The last six digits of the product WLAN name are the same as the last six digits of the product SN.
- For the first connection, log in with the initial password. You can obtain the initial password from the label on the device.
- To ensure account security, protect the password by changing it periodically, and keep it secure. Your password might be stolen or cracked if it is left unchanged for extended periods. If a password is lost, devices cannot be accessed. In these cases, the Company shall not be liable for any loss.
- If the login screen is not displayed after you scan the QR code, check whether your phone is correctly connected to the device WLAN. If not, manually select and connect to the WLAN.
- If the **This WLAN network has no Internet access. Connect anyway?** message is displayed when you connect to the built-in WLAN, tap **CONNECT**. Otherwise, you cannot log in to the system. The actual UI and messages may vary with mobile phones.

----End

D Using Smart Appliances (Owner)

D.1 Commissioning the Charger

Log in to the FusionSolar app as an owner, tap the charger on the **Home** screen, and set charger parameters. For details about how to use the charger, go to **Help and Feedback**.

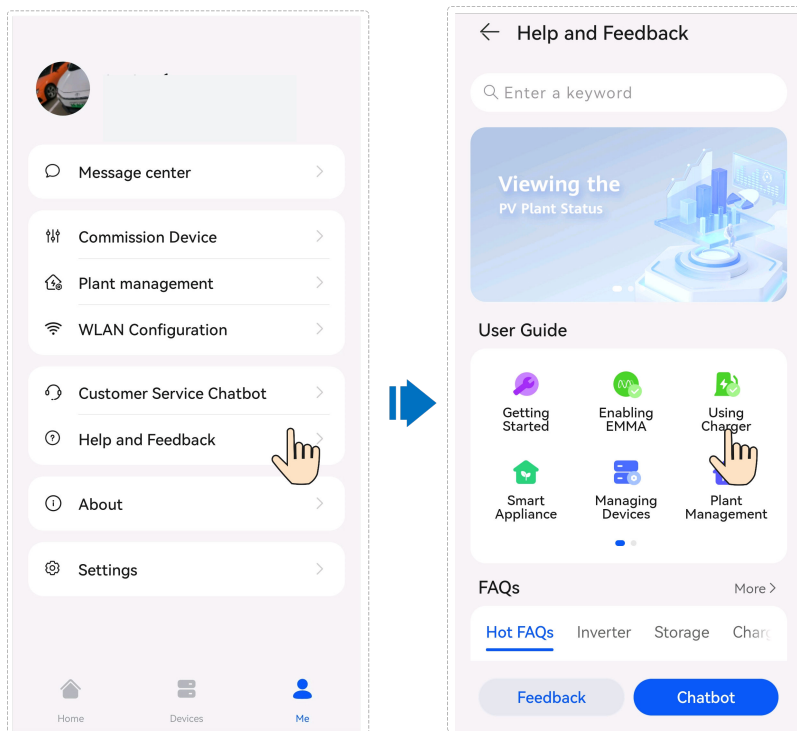

D.2 Smart Switch Commissioning

NOTE

If functions related to PV power control, such as PV power preferred, are involved, you are advised to configure smart appliances with the rated power greater than 100 W.

Appliance Settings

NOTE

- The smart switches can work properly only when there are stable WLAN signals. If the signals are unstable, the switches may fail to connect to WLAN or frequently go offline. Different brands of smart switches may have different WLAN requirements. For details, see the product manuals or contact your supplier.
- Before the installation, ensure that the home router can cover the position of the smart switches with stable network connection, and perform the commissioning and verification.

1. Connect a smart switch to the same router as the EMMA. For details, see the quick guide delivered with the smart switch.
2. Open the FusionSolar app, choose **Devices** > **Appliances**, add the smart switch, and set the parameters such as the PV power parameters and power consumption priorities.

NOTE

In the SmartGuard networking scenario, **Off-grid Load Control** does not take effect for smart appliances connected to non-backup power ports.

Connecting to Multiple Smart Switches

To avoid confusion when multiple smart switches are powered on at the same time, power on and commission them one by one.

For example, if two smart circuit breakers (Shelly Pro 2PM) are installed in the living room, perform the following steps:

1. When installing the smart circuit breakers, record their positions by taking photos and notes, and number them.

Table D-1 Recording the names of the smart switches

Shelly Pro 2PM	Shelly Pro 2PM
Living room 1	Living room 2

2. Power on the smart circuit breaker "Living room 1," search for it in the Shelly app, and connect it to the router.
3. Log in to the FusionSolar app as an owner, search for it, and change its name. Bind it to the corresponding load based on the actual cable connection.

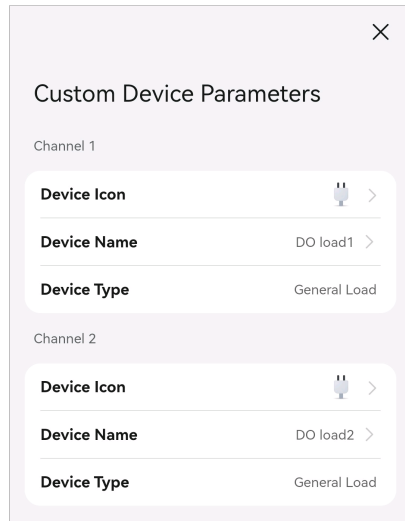

4. Repeat steps 2 and 3 to power on and commission the smart circuit breaker "Living room 2."

 **NOTE**

If multiple smart switches have been powered on without records in advance, you can power them on or off on the Shelly app to distinguish them.

E Contact Information

If you have any questions about this product, please contact us.



<https://digitalpower.huawei.com>

Path: **About Us > Contact Us > Service Hotlines**

To ensure faster and better services, we kindly request your assistance in providing the following information:

- Model
- Serial number (SN)
- Software version
- Alarm ID or name
- Brief description of the fault symptom

 **NOTE**

EU Representative Information: Huawei Technologies Hungary Kft.

Add.: HU-1133 Budapest, Váci út 116-118., 1. Building, 6. floor.

Email: hungary.reception@huawei.com

F Digital Power Customer Service



<https://digitalpower.huawei.com/robotchat/>

G Preconfigured Certificate Disclaimer

The Huawei-issued certificates preconfigured on Huawei devices during manufacturing are mandatory identity credentials for Huawei devices. The disclaimer statements for using the certificates are as follows:

1. Preconfigured Huawei-issued certificates are used only in the deployment phase, for establishing initial security channels between devices and the customer's network. Huawei does not promise or guarantee the security of preconfigured certificates.
2. The customer shall bear consequences of all security risks and security incidents arising from using preconfigured Huawei-issued certificates as service certificates.
3. A preconfigured Huawei-issued certificate is valid from the manufacturing date until December 29, 2099.
4. Services using a preconfigured Huawei-issued certificate will be interrupted when the certificate expires.
5. It is recommended that customers deploy a PKI system to issue certificates for devices and software on the live network and manage the lifecycle of the certificates. To ensure security, certificates with short validity periods are recommended.

NOTE

You can view the validity period of a preconfigured certificate on the network management system.

H Acronyms and Abbreviations

A

AC	alternating current
APP	application
ATS	auto transfer switching

C

COM	communication
-----	---------------

D

DI	digital input
DO	digital output

E

ETH	Ethernet
-----	----------

G

GE	gigabit Ethernet
----	------------------

L

LAN local area network

LED light-emitting diode

N

NC normally closed

NO normally open

P

POE power over Ethernet

PE protective earthing

R

RST reset

RH relative humidity

S

SOC state of charge

SOH state of health

SN serial number

W

WAN wide area network