



# X3-MIC G2 Series

## User Manual

3 kW - 15 kW



### **SolaX Power Network Technology(Zhejiang) Co., Ltd.**

ADD: No. 288 Shizhu Road, Tonglu Economic Development Zone,  
Dongxing District, Tonglu City, Zhejiang Province, China.

Tel: +86 0571-56260011

E-mail: info@solaxpower.com

614.00608.03

EN

#### Copyright Declaration

The copyright of this manual belongs to SolaX Power Network Technology(Zhejiang) Co., Ltd. Any corporation or individual should not plagiarize, partially or fully copy (including software, etc.), and no reproduction or distribution of it in any form or by any means. All rights reserved. SolaX Power Network Technology (Zhejiang) Co.,Ltd. reserves the right of final interpretation.

[www.solaxpower.com](http://www.solaxpower.com)

# Contents

<b>1 Note on this Manual</b> .....	<b>03</b>
1.1 Scope of Validity .....	03
1.2 Target Group .....	03
1.3 Symbols Used .....	03
<b>2 Safety</b> .....	<b>04</b>
2.1 Appropriate Usage .....	04
2.2 Important Safety Instructions .....	06
2.3 Explanation of Symbols .....	08
2.4 CE Directives .....	10
<b>3 Introduction</b> .....	<b>11</b>
3.1 Basic Features .....	11
3.2 Terminals of Inverter.....	11
3.3 Dimension .....	12
<b>4 Technical Data</b> .....	<b>13</b>
4.1 DC Input .....	13
4.2 AC Output .....	13
4.3 Efficiency, Safety and Protection.....	14
4.4 General Data .....	14
<b>5 Installation</b> .....	<b>15</b>
5.1 Check for Transport Damage .....	15
5.2 Packing List .....	15
5.3 Installation Precaution .....	16
5.4 Installation Steps .....	17
5.5 Connection of the Inverter.....	18
5.6 Run the Inverter .....	30
<b>6 Operation Method</b> .....	<b>31</b>
6.1 Control Panel.....	31
6.2 LCD Function .....	32
6.3 LCD Operation .....	33

**7 Troubleshooting** ..... 47

7.1 Trouble Shooting ..... 47

7.2 Routine Maintenance ..... 49

**8 Decommissioning** ..... 50

8.1 Dismantling the Inverter ..... 50

8.2 Packaging ..... 50

8.3 Storage and Transportation ..... 50

8.4 Waste Disposal ..... 50

**9 Disclaimer** ..... 51

**\* Warranty Registration Form**

# 1 Notes on this Manual

## 1.1 Scope of Validity

This manual is an integral part of X3-MIC G2 Series. It describes the assembly, installation, commissioning, maintenance and fault of the product. Please read it carefully before operating.

<b>X3-MIC-3K-G2</b>	<b>X3-MIC-4K-G2</b>
<b>X3-MIC-5K-G2</b>	<b>X3-MIC-6K-G2</b>
<b>X3-MIC-8K-G2</b>	<b>X3-MIC-10K-G2</b>
<b>X3-MIC-12K-G2</b>	<b>X3-MIC-15K-G2</b>

Note: **"X3"** means three-phase. **"MIC"** is the name of the product series. **"3K"** means 3 kW. **"G2"** means second generation. The products of this series have dual MPPT strings with DC Switch and with LCD screen. Keep this manual at where it is accessible all the time.

## 1.2 Target Group

This manual is for qualified electricians. The tasks described in this manual only can be performed by qualified electricians.

## 1.3 Symbols Used

The following types of safety instructions and general information appear in this document as described below:



**Danger!**  
 "Danger" indicates a hazardous situation which, if not avoided, will result in serious injury or death.



**Warning!**  
 "Warning" indicates a hazardous situation which, if not avoided, could result in serious injury or death.



**Caution!**  
 "Caution" indicates a hazardous situation which, if not avoided, could result in minor or moderate injury.



**Note!**  
 "Note" provides tips that are valuable for the optimal operation of your product.

## 2 Safety

### 2.1 Appropriate Usage

The X3-MIC G2 Series are PV inverters which can convert the DC current of the PV generator into AC current and feed it into the public grid.

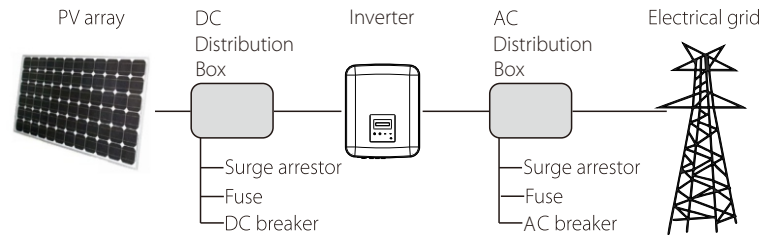

figure 1

#### ► Surge protection devices (SPDs) for PV installation

**WARNING !**

Over-voltage protection with surge arresters should be provided when the PV power system is installed. The grid connected inverter is fitted with SPDs in both PV input side and MAINS side.

Lightning will cause a damage either from a direct strike or from surges due to a nearby strike.

Induced surges are the more likely cause of lightning damage in the majority of installations, especially in rural areas where electricity is usually provided by long overhead lines. Surges may be induced on both the PV array conductors or the AC cables leading to the building.

Specialists in lightning protection should be consulted in the actual application. Using appropriate external lightning protection, the effect of a direct lightning strike into a building can be mitigated in a controlled way, and the lightning current can be discharged into the ground.

Installation of SPDs to protect the inverter against mechanical damage and excessive stress include a surge arrester in case of a building with external lightning protection system (LPS) when separation distance is kept.

To protect the DC system, surge suppression device (SPD type 2) should be fitted at the inverter end of the DC cabling and at the array located between the inverter and the PV generator, if the voltage protection level (VP) of the surge arresters is greater than 1100V, an additional SPD type 3 required for surge protection for electrical devices.

To protect the AC system, surge suppression devices (SPD type2) should be fitted at the main incoming point of AC supply (at the consumer's cutout), located between the inverter and the meter/distribution system; SPD (test impulse D1) for signal line according to EN 61632-1.

All DC cables should be installed to provide as short a run as possible, and positive and negative cables of the string or main DC supply should be bundled together. Avoiding the creation of loops in the system. This requirement for short runs and bundling includes any associated earth bundling conductors.

Spark gap devices are not suitable to be used in DC circuits once conducting, they won't stop conducting until the voltage across their terminals is typically below 30 volts.

#### ► Anti-Islanding Effect

Islanding effect is a special phenomenon that grid-connected PV system still supplies power to the nearby grid when the grid loss happened in the power system. It is dangerous for maintenance personnel and the public. X3-MIC G2 series provide Active Frequency Drift(AFD) to prevent islanding effect.

## 2.2 Important Safety Instructions



### Danger!

#### Danger to life due to high voltages in the inverter!

- All work must be carried out by qualified electrician.
- The appliance is not to be used by children or persons with reduced physical sensory or mental capabilities, or lack of experience and knowledge, unless they have been given supervision or instruction.
- Children should be supervised to ensure that they do not play with the appliance.



### Caution!

#### Danger of burn injuries due to hot enclosure parts!

- During operation, the upper lid of the enclosure and the enclosure body may become hot.
- Do not touch the metallic part of the product during operation.



### Caution!

#### Possible damage to health as a result of the effects of radiation!

- Do not stay closer than 20 cm to the inverter for a long time.



### Note!

#### Grounding the PV generator.

- Comply with the local requirements for grounding the PV modules and the PV generator. SolaX recommends connecting the generator frame and other electrically conductive surfaces in a manner which ensures continuous conduction and ground these in order to have optimal protection of system and persons.



### Warning!

- Ensure input DC voltage  $\leq$  Max. DC voltage. Over voltage may cause permanent damage to the inverter or other losses, which will not be included in warranty!



### Warning!

- Authorized service personnel must disconnect both AC and DC power from X3-MIC G2 series before attempting any maintenance or cleaning or working on any circuits connected to the X3-MIC G2 series.



### WARNING !

Do not operate the inverter when the device is running.



### WARNING !

Risk of electric shock!

- Prior to the application, please read this section carefully to ensure correct and safe application. Please keep the user manual properly.
- Use only attachments recommended or sold by SolaX. Otherwise may result in a risk of fire, electric shock, or injury to person.
- Make sure that existing wiring is in good condition and that wire is not undersized.
- Do not disassemble any parts of inverter which are not mentioned in installation guide. It contains no user-serviceable parts. See Warranty for instructions on obtaining service. Attempting to maintain the X3-MIC Series inverter by yourself may result in a risk of electric shock or fire and will void your warranty.
- Keep away from flammable, explosive materials to avoid fire disaster.
- The installation place should be away from humid or corrosive substance.
- Authorized service personnel must use insulated tools when installing or working with this equipment.
- PV modules shall have an IEC 61730 class A rating.
- Never touch either the positive or negative pole of PV connecting device. Strictly prohibit touching both of them at the same time.
- The unit contains capacitors that remain charged to a potentially lethal voltage after the MAINS and PV supply has been disconnected.
- Hazardous voltage will present for up to 5 minutes after disconnection from power supply.
- CAUTION - RISK of electric shock from energy stored in capacitor. Never operate on the solar inverter couplers, the MAINS cables, PV cables or the PV generator when power is applied. After switching off the PV and Mains, always wait for 5 minutes to let the intermediate circuit capacitors discharge before you unplug DC and MAINS couplers.
- When accessing the internal circuit of solar inverter, it is very important to wait 5 minutes before operating the power circuit or demounting the electrolyte capacitors inside the device. Do not open the device before hand since the capacitors require time to sufficiently discharge!
- Measure the voltage between terminals UDC+ and UDC- with a multi-meter (impedance at least 1Mohm) to ensure that the device is discharged before beginning work (35 VDC) inside the device.

### PE Connection and Leakage Current

- The end-use application shall monitor the protective conductor by residual current operated protective device (RCD) with rated fault current  $I_{fn} \leq 240$  mA which automatically disconnects the device in case of a fault.
- DC differential currents are created (caused by insulation resistance and through capacities of the PV generator). In order to prevent unwanted triggering during operation, the rated residual current of the RCD has to be min 240 mA.

The device is intended to connect to a PV generator with a capacitance limit of approx 700 nF.

	<b>WARNING !</b> High leakage current! Earth connection essential before connecting supply.
--	---------------------------------------------------------------------------------------------------

- Incorrect grounding can cause physical injury, death or equipment malfunction and increase electromagnetic.
- Make sure that grounding conductor is adequately sized as required by safety regulations.
- Do not connect the ground terminals of the unit in series in case of a multiple installation. This product can cause current with a d.c component, Where a residual current operated protective (RCD) or monitoring (RCM) device is used for protection in case of direct or indirect contact, only an RCD or RCM of type B is allowed on the supply side of this product.

#### For United Kingdom

- The installation that connects the equipment to the supply terminals shall comply with the requirements of BS 7671.
- Electrical installation of PV system shall comply with requirements of BS 7671 and IEC 60364-7-712.
- No protection settings can be altered.
- User shall ensure that equipment is so installed, designed and operated to maintain at all times compliance with the requirements of ESQCR22(1)(a).

#### For Australia and New Zealand

- Electrical installation and maintenance shall be conducted by licensed electrician and shall comply with Australia National Wiring Rules.

### 2.3 Explanation of Symbols

This section gives an explanation of all the symbols shown on the inverter and on the type label.

#### • Symbols on the Inverter

Symbol	Explanation
	Operating Display.
	An error has occurred, please inform your installer immediately.

#### • Symbols on the Type Label

Symbol	Explanation
	CE mark. The inverter complies with the requirements of the applicable CE guidelines.
	RCM remark.
	TUV certification.
	Compliant with UKCA standards.
	Compliant with UKNI standards.
	Beware of hot surface. The inverter can become hot during operation. Avoid contact during operation.
	Danger of high voltages. Danger to life due to high voltages in the inverter!
	Danger. Risk of electric shock!
	Observe enclosed documentation.
	The inverter can not be disposed together with the household waste. Disposal information can be found in the enclosed documentation.
	Do not operate this inverter until it is isolated from mains and on-site PV generation suppliers.
	Danger to life due to high voltage. There is residual voltage in the inverter which needs 5 min to discharge. • Wait 5 min before you open the upper lid or the DC lid.
	RoHS certificate The inverter complies with the requirements of Restriction of Hazardous Substances.

## 2.4 CE Directives

This chapter follows the requirements of the European low voltage directives, which contains the safety instructions and conditions of acceptability for the end user system, which you must follow when installing, operating and servicing the unit. If ignored, physical injury or death may follow, or damage may occur to the unit. Read this instructions before you work on the unit. If you are unable to understand the dangers, warnings, cautions or instructions, please contact an authorized service dealer before installing. Operating and servicing the unit.

The Grid connected inverter meets the requirement stipulated in Low Voltage Directive (LVD) 2014/35/EU and Electromagnetic Compatibility (EMC) Directive 2014/30/EU. The unit is based on:

EN 62109-1:2010 ; EN 62109-2:2011 ; IEC 62109-1(ed.1) ; IEC62109-2(ed.1)

EN 61000-6-3:2007+A:2011 ; EN 61000-6-1:2007 ; EN 61000-6-2:2005

In case of installation in PV system, startup of the unit (i.e. start of designated operation) is prohibited until it is determined that the full system meets the requirements stipulated in EC Directive (2014/35/EU,2014/30/EU, etc.)

The grid connected inverter leave the factory completely connecting device and ready for connection to the mains and PV supply ,the unit shall be installed in accordance with national wiring regulations. Compliance with safety regulations depends upon installing and configuring system correctly, including using the specified wires. The system must be installed only by professional assemblers who are familiar with requirements for safety and EMC. The assembler is responsible for ensuring that the end system complies with all the relevant laws in the country where it is to be used.

The individual subassembly of the system shall be interconnected by means of the wiring methods outlined in national/international such as the national electric code (NFPA) No.70 or VDE regulation 0107.

## 3. Introduction

### 3.1 Basic features

Thanks for your purchasing with SolaX X3-MIC G2 Serial inverter. The X3-MIC G2 Series inverter is one of the finest inverters on the market today, incorporating state-of-the-art technology, high reliability, and convenient control features.

- Advanced DSP control technology.
- Utilize the latest high-efficiency power component.
- Optimal MPPT technology.
  - Two independent MPP Tracking.
  - Wide MPPT input range.
- Advanced anti-islanding solutions.
- IP66 protection level.
- Max. efficiency up to 98.3%. EU efficiency up to 97.8%.
- THD<3%.
- Safety & Reliability: transformerless design with software and hardware protection.
- Export control.
- Power factor regulation.
- Friendly HMI.
  - LED status indications.
  - LCD display technical data, human-machine interaction through press key.
  - PC remote control.
  - Upgrade through USB interface.
  - Pocket WiFi/LAN monitoring.
  - Energy conservation.

### 3.2 Terminals of inverter

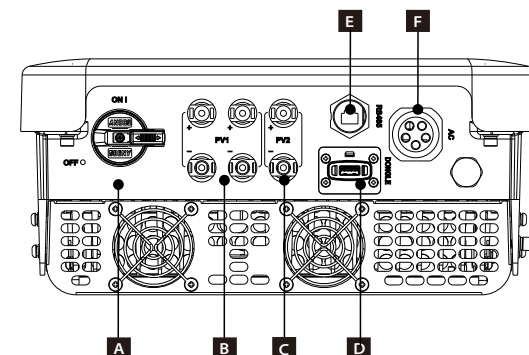

Object	Description
A	DC Switch
B	PV1 Connector
C	PV2 Connector
D	DONGLE
E	RS 485
F	AC Connector

**Warning!**

Only authorized personnel is allowed to set the connection.

## 3.3 Dimension

## ➤ Dimension

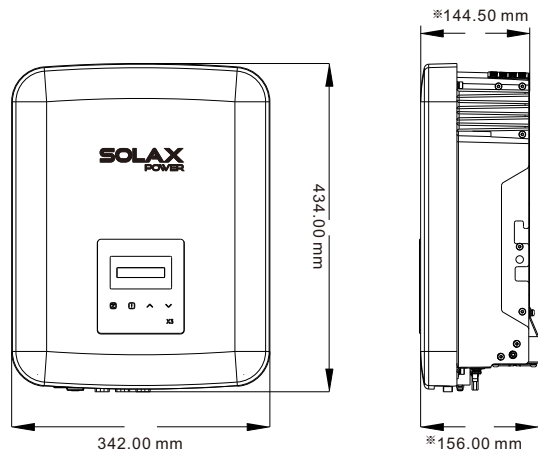

\*X3-MIC G2 Size(3 kW, 4 kW, 5 kW, 6 kW): 342mm\*434mm\*144.5mm  
 X3-MIC G2 Size(8 kW, 10 kW, 12 kW, 15 kW): 342mm\*434mm\*156mm

## 4. Technical Data

## 4.1 DC input

Model	X3-MIC-3K-G2	X3-MIC-4K-G2	X3-MIC-5K-G2	X3-MIC-6K-G2	X3-MIC-8K-G2	X3-MIC-10K-G2	X3-MIC-12K-G2	X3-MIC-15K-G2
Max. PV array input power [W]	6000	8000	10000	12000	16000	20000	24000	30000
Max. PV input voltage [V]	1000	1000	1000	1000	1000	1000	1000	1000
Nominal input voltage [V]	640	640	640	640	640	640	640	640
MPPT voltage range [V]	120-980	120-980	120-980	120-980	120-980	120-980	120-980	120-980
MPPT voltage range@ full load [V]	130-800	170-800	210-800	260-800	315-800	395-800	315-800	395-800
Max. input current (input A/input B) [A]	16/16	16/16	16/16	16/16	16/16	16/16	32/16	32/16
Max. short circuit current (input A/input B) [A]	18/18	18/18	18/18	18/18	18/18	18/18	36/18	36/18
Startup voltage [V]	150	150	150	150	150	150	150	150
No. of MPPT	2	2	2	2	2	2	2	2
Strings per MPPT	1/1	1/1	1/1	1/1	1/1	1/1	2/1	2/1
DC disconnection switch	Standard							

## 4.2 AC output

Model	X3-MIC-3K-G2	X3-MIC-4K-G2	X3-MIC-5K-G2	X3-MIC-6K-G2	X3-MIC-8K-G2	X3-MIC-10K-G2	X3-MIC-12K-G2	X3-MIC-15K-G2
Nominal AC output power [VA]	3000	4000	5000	6000	8000	10000	12000	15000
Max. AC output apparent power [VA]	3300	4400	5500	6600	8800	11000	13200	15000
Nominal AC voltage [V]	230/400 3~N/PE							
Nominal grid frequency [Hz]	50/60 (±5)							
Nominal AC output current [A]	4.3	5.8	7.2	8.7	11.6	14.5	17.4	21.7
Max. AC output current [A]	4.8	6.4	8.0	9.6	12.8	16.0	19.1	22.7
Inrush current [A]	27							
THDI, rated power [%]	<3%							
Displacement power factor	0.8 leading ~ 0.8 lagging							
Feed in phase	Three-phase							



### 4.3 Efficiency, Safety and Protection

Model	X3-MIC-3K-G2	X3-MIC-4K-G2	X3-MIC-5K-G2	X3-MIC-6K-G2	X3-MIC-8K-G2	X3-MIC-10K-G2	X3-MIC-12K-G2	X3-MIC-15K-G2
MPPT efficiency	99.90%	99.90%	99.90%	99.90%	99.90%	99.90%	99.90%	99.90%
Euro efficiency	97.80%	97.80%	97.80%	97.80%	97.80%	97.80%	97.80%	97.80%
Max. efficiency	98.30%	98.30%	98.30%	98.30%	98.30%	98.30%	98.30%	98.30%
<b>Safety &amp; Protection</b>								
Over/under voltage protection				YES				
DC isolation protection				YES				
Monitoring ground fault protection				YES				
Grid protection				YES				
DC injection monitoring				YES				
Back feed current monitoring				YES				
Residual current detection				YES				
Anti-islanding protection				YES				
Over load protection				YES				
Over heat protection				YES				

### 4.4 General Data

Model	X3-MIC-3K-G2	X3-MIC-4K-G2	X3-MIC-5K-G2	X3-MIC-6K-G2	X3-MIC-8K-G2	X3-MIC-10K-G2	X3-MIC-12K-G2	X3-MIC-15K-G2
Dimension [W/H/D](mm)	342*434*144.5				342*434*156			
Dimension of packing [W/H/D](mm)	433*515*247							
Net weight [kg]	15.5	15.5	15.5	15.5	17.0	17.0	18.0	18.0
Installation	Wall-mounted							
Operating temperature range [°C]	-30~+60 (derating at 45)							
Storage temperature [°C]	-30~+60							
Storage/Operation relative humidity	0%~100%, condensation							
Altitude [m]	4000 (derating at 3000)							
Ingress Protection	IP66 (for outdoor use)							
Isolation type	Transformerless							
Protective Class	Class I							
Night-time consumption	<3 W							
Over Voltage Category	III(MAINS), II(PV)							
Pollution Degree	II(inside), III(outside)							
Cooling	Natural cooling				Fan cooling			
Noise level	<30 dB				<45 dB		<50 dB	
Inverter Topology	Non-isolated							
Communication interface	USB / RS485 / DRM / Pocket WiFi (Optional: Pocket LAN/4G)							
Standard warranty [year]	5 (10 optional)							

## 5. Installation

### 5.1 Check for Transport Damage

Make sure the inverter is intact during transportation. If there are some visible damages, such as cracks, please contact your dealer immediately.

### 5.2 Packing List

Open the package and fetch out the product, check the accessories at first. The packing list is shown as below.

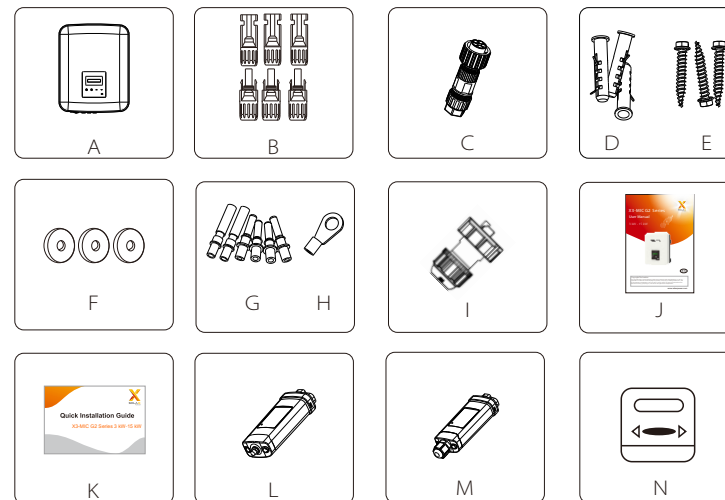

Object	Quantity	Description
A	1	X3-MIC G2 series inverter
B	4/6	DC connector (4 for 3 kW-10 kW; 6 for 12 kW-15 kW)
C	1	AC connector
D	3	Expansion bolt
E	3	self tapping screw
F	3	Round washer
G	4/6	DC pin contact(2*positive, 2*negative for 3 kW-10 kW) (3*positive, 3*negative for 12 kW-15 kW)
H	1	Earth terminal
I	1	Waterproof connector with RJ45
J	1	Product manual
K	1	Quick installation guide
L	1	Pocket WiFi
M	1	Pocket LAN (Optional)
N	1	Meter (Optional)

### 5.3 Installation Precaution

X3-MIC G2 Series inverter is designed for outdoor installation (IP 66). Make sure the installation site meets the following conditions:

- Not in direct sunlight.
  - Not in areas where highly flammable materials are stored.
  - Not in potential explosive areas.
  - Not near the television antenna or antenna cable.
  - Not higher than the maximum operating altitude of the inverter.
  - Not in environment of precipitation or humidity.
  - Be sure the ventilation is good enough.
  - The ambient temperature in the range of  $-30^{\circ}\text{C}$  to  $+60^{\circ}\text{C}$ .
  - The slope of the wall should be within  $\pm 5^{\circ}$ .
- The wall hanging the inverter should meet conditions as below:
1. solid brick/concrete, or strength equivalent mounting surface;
  2. Inverter must be supported or strengthened if the wall's strength isn't enough (such as wooden wall, the wall covered by thick layer of decoration).

Please avoid direct sunlight, snow laying up during installing and operating.

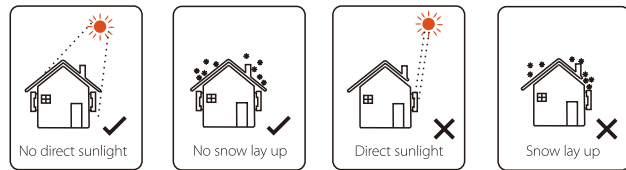

#### ➤ Available Space Size

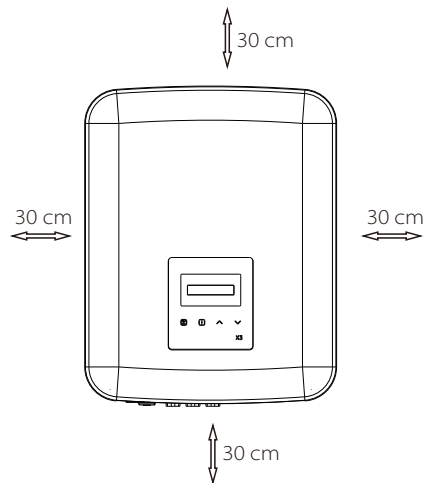

Table Available Space Size

Position	Min.size
Left	30 cm
Right	30 cm
Top	30 cm
Bottom	30 cm
Front	30 cm

### 5.4 Installation Steps

#### ➤ Preparation

Below tools are needed before installation.



Installation tools : crimping plier for binding post and RJ 45, wire crimper, stripping plier,  $\phi 10$  driller, screwdrivers, manual wrench and allen wrench.

#### ➤ Step 1: Screw the wall bracket on the wall

- Unscrew the bracket from the back of the inverter. Use it as a template to mark the position of the 3 holes ( $223\text{ mm} \times 30\text{ mm}$ ) on the wall.
- Drill holes with the driller, make sure the holes are deep enough (at least 60mm) for installation.
- Insert the expansion bolts in the holes. Then install the wall bracket by screwing the expansion screws.

#### ➤ Step 2: Match the inverter with wall bracket

- Hang the inverter over the bracket, move the inverter close to it, slightly lay down the inverter, and make sure the 2 grooves on the back of the inverter are fixed well with the 2 lugs on the bracket. Screw the cross recessed screw on the right side.

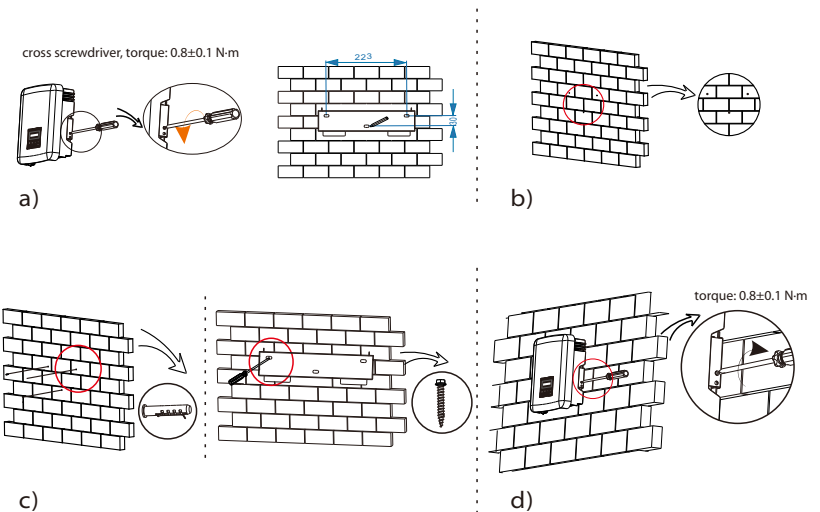

## 5.5 Connection of the Inverter

### 5.5.1 The Main Steps to Connect to the Inverter

#### ➤ PV String Connection

X3-MIC G2 series inverters have a couple of PV connectors which can be connected in series into 2-strings PV modules. Please select PV modules with excellent function and reliable quality. Open circuit voltage of module array connected should be < Max. DC input voltage (table as below), and operating voltage should be within the MPPT voltage range.

**Table 3 Max. DC Voltage Limitation**

Model	X3-MIC-3K-G2	X3-MIC-4K-G2	X3-MIC-5K-G2	X3-MIC-6K-G2	X3-MIC-8K-G2	X3-MIC-10K-G2	X3-MIC-12K-G2	X3-MIC-15K-G2
Max. DC Voltage	980 V							



**Warning!**

The voltage of PV modules is very high and dangerous, please comply with the electric safety rules when connecting.



**Warning!**

Do not ground the positive or negative pole of the photovoltaic module!



**Note!**

Please follow the requirements of PV modules as below:  
Same type; Same quantity; Identical alignment; Identical tilt.  
In order to save cable and reduce the DC loss, we suggest installing the inverter near PV modules.



**Danger!**

Danger to life due to high voltage on DC conductors. When exposed to sunlight, the PV array generates dangerous DC voltage which is present in the DC conductors. Touching the DC conductors can lead to lethal electric shocks. Do not cover the PV modules.

### ● Connection Steps

Below tools are needed before connection.



- a) Choose an appropriate cable(2.5-4 mm<sup>2</sup>) to connect the PV module.
- b) Strip 6 mm of insulation from the wire end by using the stripping pliers.

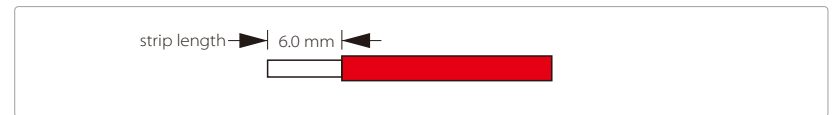

- c) Insert stripped wire into pin contact and ensure all conductor strand are captured in the pin contact.



- d) Crimp pin contact by using the wire crimper.

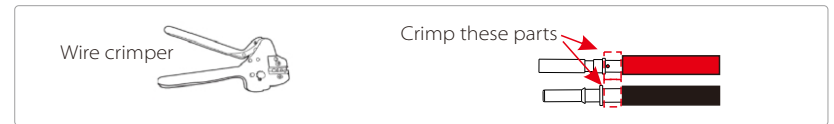

- e) Loosen the cable nut from the DC connector. Then insert the wire with pin contact through the cable nut.
- f) Insert the wire into plug forcibly, when a "click" is heard or felt the pin contact assembly is seated correctly. Then tighten the cable nut.

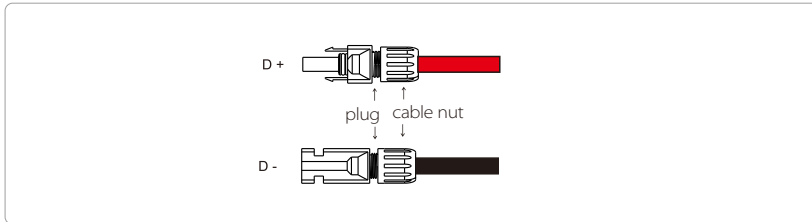

Schematic diagram of the inverter PV connected.

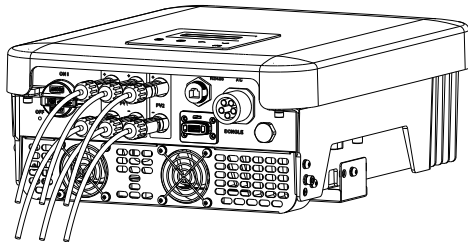

➤ **Grid Connection**

X3-MIC G2 series inverters are designed for three phase grid. Rated grid voltage is 230 V, frequency is 50/60 Hz. Other technical requests should comply with the requirement of the local public grid.

**Table 4 Cable and Micro-breaker recommended**

Model	X3-MIC-3K-G2	X3-MIC-4K-G2	X3-MIC-5K-G2	X3-MIC-6K-G2	X3-MIC-8K-G2	X3-MIC-10K-G2	X3-MIC-12K-G2	X3-MIC-15K-G2
L1,L2,L3,N Cable	4-5 mm <sup>2</sup>	4-5 mm <sup>2</sup>	4-5 mm <sup>2</sup>	5-6 mm <sup>2</sup>	5-6 mm <sup>2</sup>	5-6 mm <sup>2</sup>	5-6 mm <sup>2</sup>	6-8 mm <sup>2</sup>
PE Cable	2.5-5 mm <sup>2</sup>	2.5-5 mm <sup>2</sup>	2.5-5 mm <sup>2</sup>	2.5-6 mm <sup>2</sup>	2.5-6 mm <sup>2</sup>	2.5-6 mm <sup>2</sup>	2.5-6 mm <sup>2</sup>	2.5-6 mm <sup>2</sup>
Micro-breaker	16 A	16 A	16 A	20 A	32 A	32 A	32 A	32 A

\*The parameters have some differences because of different environment and material. Please choose appropriate cable and micro-breaker according to the local conditions.

Micro-breaker should be installed between inverter and grid, any loads should not be connected with inverter directly.

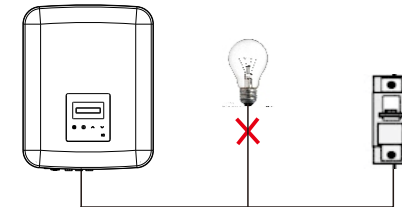

**Incorrect Connection between Load and Inverter**

• Connection Steps

- a) Check the grid voltage and compare with the permissive voltage range (refer to technical data).
- b) Disconnect the circuit-breaker from all the phases and secure against re-connection.
- c) Strip the wires:
  - Strip all the wires to 52.5 mm and the PE wire to 55 mm.
  - Use the stripping pliers to strip 12 mm of insulation from wire ends as below.

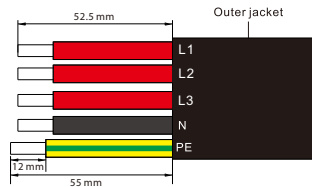

- d) Separate the AC plug into three parts as below.
  - Hold the middle part of the male insert, rotate the back shell to loose it, and detach it from male insert.
  - Remove the cable nut (with rubber insert) from the back shell.



- e) Slide the cable nut and then back shell onto the cable.

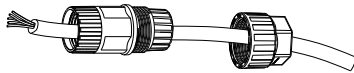

- f) Insert the stripped end of the five wires into the appropriate holes of the male insert (The N wire and PE wire must be connected correctly), and then tighten each screw to tight each wire in place (Use the accompanying inner hexagon spanner).

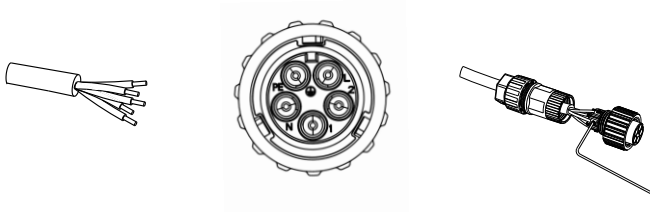

- g) Tighten the screw of the back shell and the male insert.

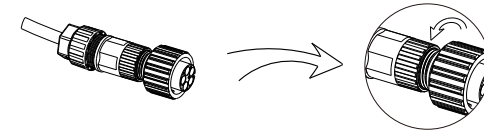

- h) Tighten the screw of the back shell and the cable nut.

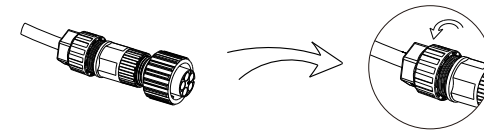

- i) Align the groove of male terminal with the convex of female terminal, then tighten the bush in male terminal.

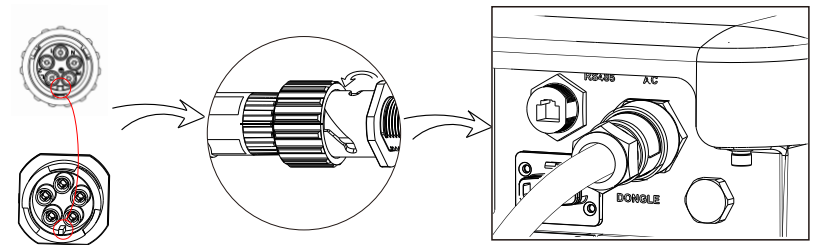

### Selection of Fuses and Cables Connection

Mains cable (AC line cable) shall be short-circuit protected and thermal overload protected.

Always fit the input cable with fuse. Normal gG (US: CC or T) fuses will protect the input cable in short circuit situation. They will also prevent damage to adjoining equipment.

Dimension the fuses according to local safety regulations, appropriate input voltage and the related current of the solar inverter.

AC output protected by external fuse (gG rated current 16 A/600 VAC for 4 kW /5 kW/6 kW; 20 A/600 VAC for 7 kW/8 kW/9 kW; 25 A/600 VAC for 10 kW) provides in all live connections to the AC supply.

The rated short-circuit breaking capacity of the above protective device shall be at least equal to the prospective fault current at the point of installation. See section technical data of this manual for details.

AC output cable: Cu; R,S,T, N+PE: 3\*4.0mm<sup>2</sup>+4.0mm<sup>2</sup> for 4 kW /5 kW/6 kW and 2\*5.3mm<sup>2</sup>+5.3mm<sup>2</sup> for 7 kW/8 kW; 3\*5.3mm<sup>2</sup>+5.3mm<sup>2</sup> for 10 kW, 3\*6mm<sup>2</sup>+6mm<sup>2</sup> for 12 kW/15 kW@40°C ambient temperature with a max length of 5m, with operating time of the fuses is less than 5 seconds, installation method B2 according to EN60204-1:2006, annex D: cable in conduit cable trunking system, number of loaded circuit only one. Use H07RNF (cord designation 60245 IEC66) for an ambient temperature of 40°C or less and use 90°C wire for ambient temperature between 40°C and 60°C.

#### Note!



1. For condition differing from those mentioned above, dimension the cables according to local safety regulations, appropriate input voltage and the load current of the unit. (You can choose a thicker cable but the fuses must be rated according to the rating of the cable.)
2. Fuses must be approved by Notified Body.
3. The AC output cable would be better to use the soft wire.

Therefore the current-carrying capacity of the components and sub-assemblies provided in the end-use system(connectors, cables, junction box, switchgear, etc.) and the reverse current PV modules shall be considered based on the feedback current and reverse current. The direct current(DC) circuit breaker or fuse between each solar generator and inverter shall be provided based on solar inverter input ratings.

Select DC cables based on the above inverter back-feed current and ISC PV rating and Vmax ratings.

### ➤ Earth Connection

Screw the ground screw with the allen wrench shown as follows.

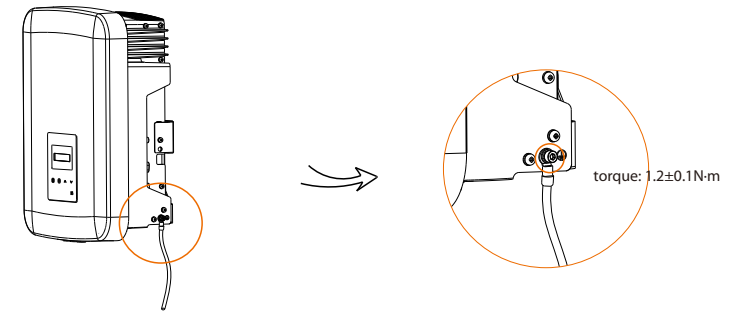

### 5.5.2 Communication interface

This product has a series of communication interfaces: such as WiFi, RS485/Meter, DRM and USB for upgrading for human and machine communication. Operating information like output voltage, current, frequency, faulty information, etc., can be delivered to PC or other monitoring equipment via these interfaces.

#### ① WiFi (Standard) /LAN (Optional)

This inverter provides a WiFi/LAN port which can collect information from inverter including status, performance and updating information to monitoring website via connecting Pocket WiFi (Pocket LAN can be purchased from the supplier for optional if needed)

#### Connection steps:

Please check the Pocket WiFi user manual for more details.

② RS485/Meter

a. RS485

This is a communication interface provided for engineer to adjust the inverter.

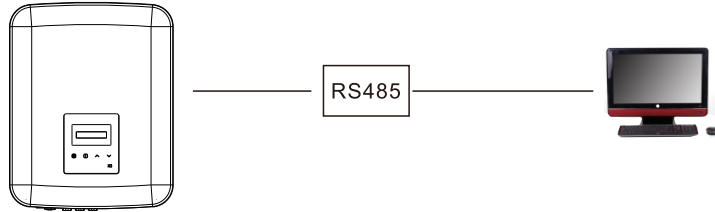

b. Meter(optional)

A meter can communicate with the X3-MIC G2 series inverter through this interface, then you can:

1. Monitor the energy to grid and from grid throughout the whole day.
2. Achieve the export control function with a higher accuracy.

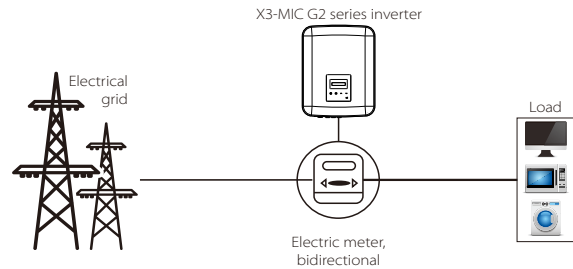

The PIN definitions of RS485/Meter interface are as below.

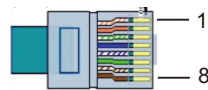

PIN	1	2	3	4	5	6	7	8
Definition	+12V	DRM0	RY-OUT	485_A	485_B	GND	NC	NC

**Note!**  
 The smart meter must be authorized by SolaX, any third party or non-authorized meter may not match with the inverter. SolaX will not take the responsibility if the unauthorized meter is unavailable.

RS485 Connection Steps:

1. Prepare RJ45 connector and a communication cable.
2. Strip the insulation from the communication cable.
3. Let the communication cable pass through the waterproof connector with RJ45, then insert it into the RJ45 connector following the PIN definition rule.

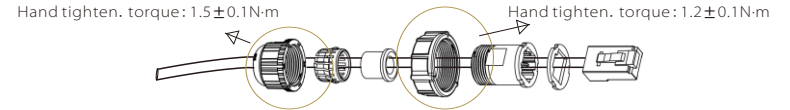

4. Crimp the RJ45 connector with the crimping plier.
5. Insert the cable into the RS485/Meter port of the inverter, and tighten the waterproof connector.

Meter Connection Steps:

Please see the Quick Installation Guide for three-Phase Meter for details.

③ DRM

DRM is provided to support several demand response modes by giving control signals as below.

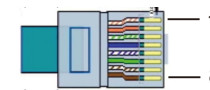

Pin	1	2	3	4	5	6	7	8
Definition	+12V	DRM0	X	X	X	X	X	X

Connection Steps:

1. Prepare RJ45 connector and a communication cable.
2. Strip the insulation from the communication cable.
3. Let the communication cable pass through the waterproof plug, then insert it into the RJ45 connector following the PIN definition rule.
4. Crimp the RJ45 connector with the crimping plier.
5. Insert the cable into the DRM port of the inverter, and tighten the waterproof plug.

④ Upgrade

The inverter system can be updated through an U-disk.



**Warning!**

Make sure the input voltage is more than 140 V (in good illumination condition), or it may result in failing during updating.

**Upgrade Steps:**

1) Please contact our service support to get the update file, and extract it into your U-disk as the following file path:

"update\ARM\618.xxxxx.00\_MICPROG2\_ARM\_Vx.xx\_xxxxxxxx.usb";  
 "update\DSP\618.xxxxx.00\_MICPROG2\_DSP\_Vx.xx\_xxxxxxxx.usb".

Note: Vx.xx is version number, xxxxxxxx is file completion date.



**Warning!**

Make sure the directory is in accordance with above form strictly! Do not modify the program file name ! Or it may cause the inverter to stop working!

2) Make sure the DC switch is off and the AC is disconnected with grid. If the Pocket WiFi is connected to the port, please remove the Pocket WiFi at first.

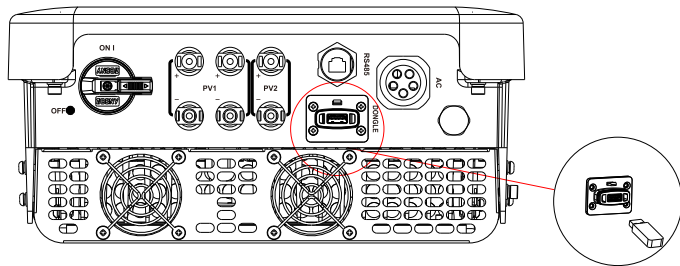

3) Then insert the U-disk into the DONGLE port on the bottom of the inverter. Then turn on DC switch and connect the PV connector, the LCD will show a picture as below.

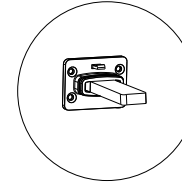
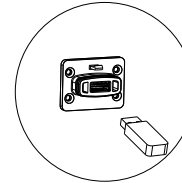

===== Update =====



4) Press "Up" and "Down" to select ARM or DSP. Then long press "Down", and select the correct update file to confirm the update. ARM and DSP shall be updated one by one.

5) After the upgrade is completed, please remember to turn off the DC switch or disconnect the PV connector, then pull off the U-disk, and connect the Pocket WiFi back.



**Warning!**

During updating, don't turn off the DC switch or disconnect the PV connector. If the updating stopped due to PV power failure, do not unplug the U-disk. When the PV power supply recovers, the update will continue. If the updating stopped due to other reasons, reinsert the U-disk to continue the update.



### 5.6 Run the inverter

Start inverter after checking all below steps:

- Check that device is fixed well on the wall.
- Make sure all the DC breakers and AC breakers are OFF.
- AC cable is connected to grid correctly.
- All PV panels are connected to inverter correctly, DC connectors which are not used should be sealed by cover.
- Make sure the external AC and DC connectors are connected.
- Turn on the DC switch to the "ON" position.

#### Start inverter

- Inverter will start automatically when PV panels generate enough energy.
- Check the status of LED indicators and LCD screen, the LED indicators should be blue and the LCD screen should display the main interface.
- If the LED indicators is not blue, please check the below:
  - All the connections are correct.
  - All the external disconnect switches are closed.
  - The DC switch of the inverter is in the "ON" position.

Below is the three different states when operating, which means inverter starting up successfully.

**Warning:** Inverter is waiting to checking when DC input voltage from panels is greater than 120 V(lowest start-up voltage) but less than 150 V(lowest operating voltage).

**Checking:** Inverter will check DC input environment automatically when DC input voltage from the PV panels exceeds 150 V and PV panels have enough energy to start inverter.

**Normal:** Inverter begins to operate normally with blue light on. Meanwhile feedback energy to grid, LCD displays present output power.

Enter the setting interface to follow the instructions when it is the first time to start up.



**Warning!**  
Power to the unit must be turned on only after installation work has been completed. All electrical connections must be carried out by qualified personnel in accordance with legislation in force in the country concerned.



**Note!**  
Please set the inverter if it is the first time to start up. Above steps are for the regular start of the inverter. If it is the first time to start up the inverter, you need to configure the settings for the inverter after start-up.

## 6. Operation Method

### 6.1 Control panel

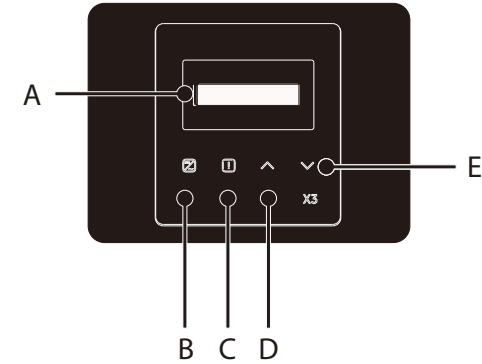

Object	Name	Description
A	LCD Screen	Display the information of the inverter.
B	LED Indicator	Light in blue: The inverter is in normal status. Flash in blue: The inverter is in waiting status.
C		Light in red: The inverter is in fault status.
D	Function Button	Up/Back button: Move cursor to upside or increase value. Return from current interface or function.
E		Down/Enter button: Move cursor to downside or decrease value. Confirm the selection.

Note:

Key	Operation	Description
^ Up/Back	Long Press	Return to the previous menu or confirm function setting
	Short Press	Look at the previous parameter or increase the value
v Down/Enter	Long Press	Go to the next menu or confirm value change
	Short Press	Look at the next parameter or decrease the value

### 6.2 LCD Display

- level 1
  - a) The first line displays the parameters(Power, Pgrid, Today and Total) and the values.
  - b) The second line shows the running status.
    - “Power” means the timely output power;
    - “Pgrid” means the power export to or import from the grid; (Positive value means the energy feeds into the grid, negative value means the energy used from the grid)
    - “Today” means the power generated within the day.
    - “Total” means the power generated until now.
- level 2
 

Long press any first-level parameter can enter the second-level “Status” parameter interface.

The user can also see other parameters, such as the Language, Date Time, Settings (need password), Meter energy, Error Logs of the inverter, and About (the user can watch the information of the inverter).
- level 3
 

Long press the second-level parameter can enter the corresponding third-level parameter interface.

  - a) Status: The user can see the U/I/P parameters of the grid and the PV, such as the Ugrid, Igrid, PF value of the grid, and the Usolar, Isolar and Psolar of the PV.
  - b) Language: This inverter provides several languages for the customer to choose.
  - c) Date Time: The user can set the date and time of the inverter.
  - d) Settings: Entering the installer password, the LCD screen will show the next page of configurable function parameters.
    - (1) Safety: The user can set the right safety standard here.
    - (2) Export Control: With this function the inverter can control energy exported to the grid. Whether having this function is based on user’s wishes.
    - (3) DRM Function (This function is mainly for Australia) : User can choose whether using the DRM function or not.

.....

**Note!**  
 The user should confirm any function setting by long press the “Up” button. If no operation is performed, the LCD screen would return to the home interface within 27 seconds in which case the function isn’t set successfully.

### 6.3 LCD Function & Operation

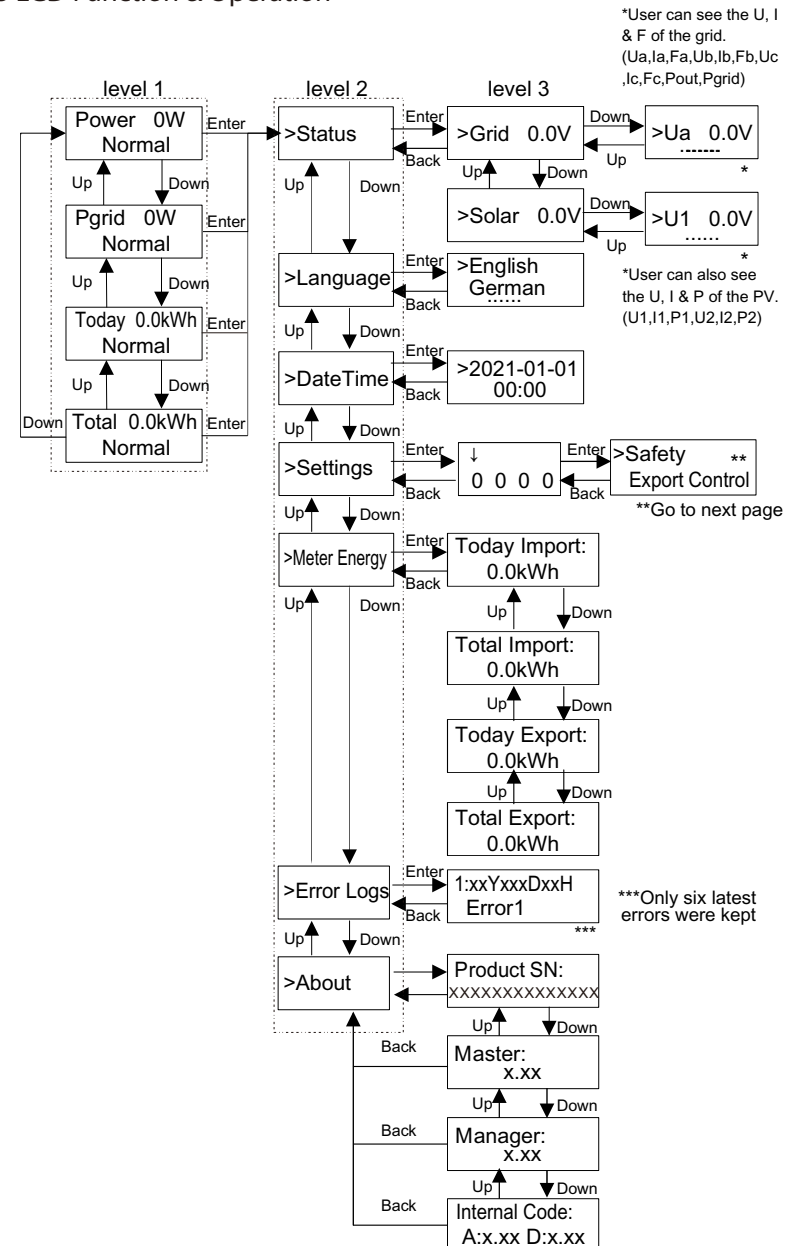

\*\*Previous page

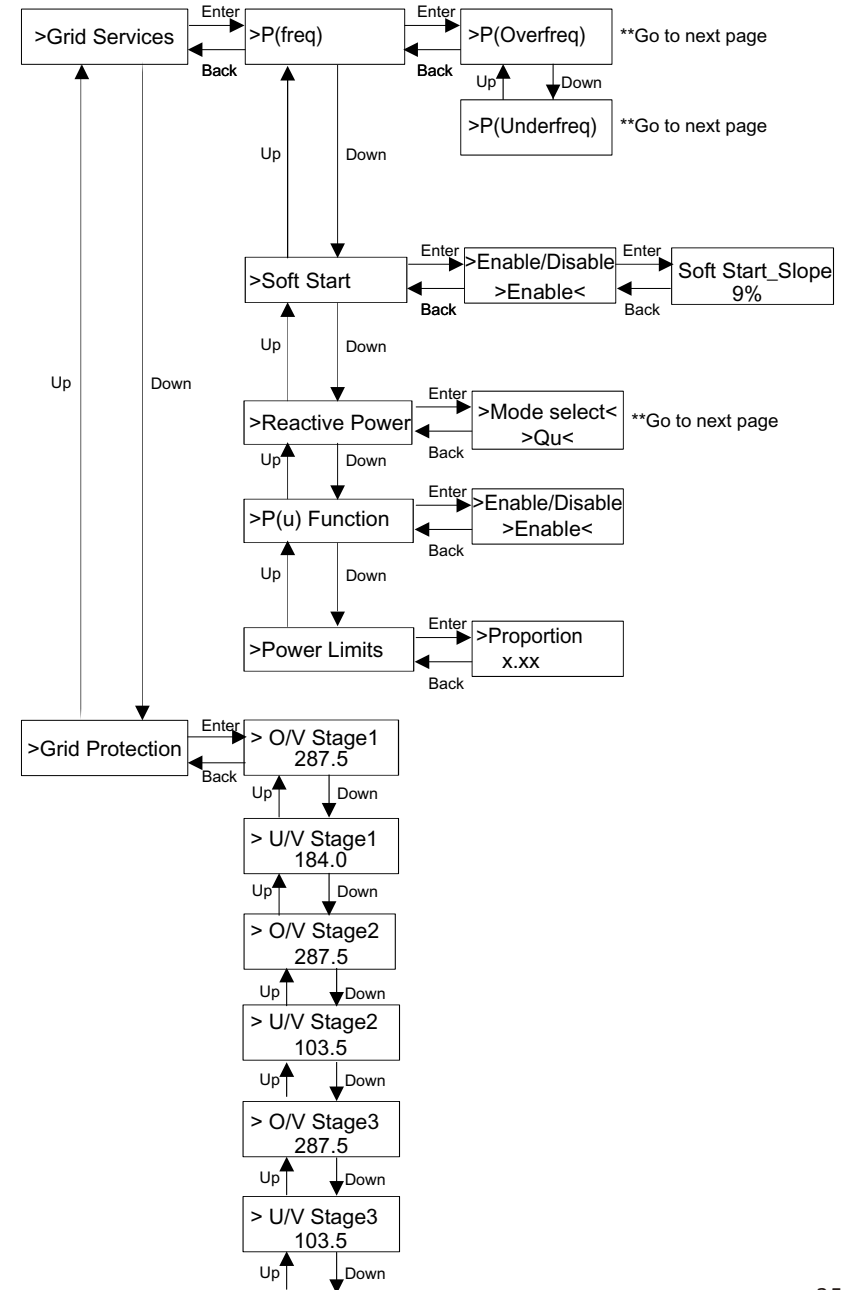
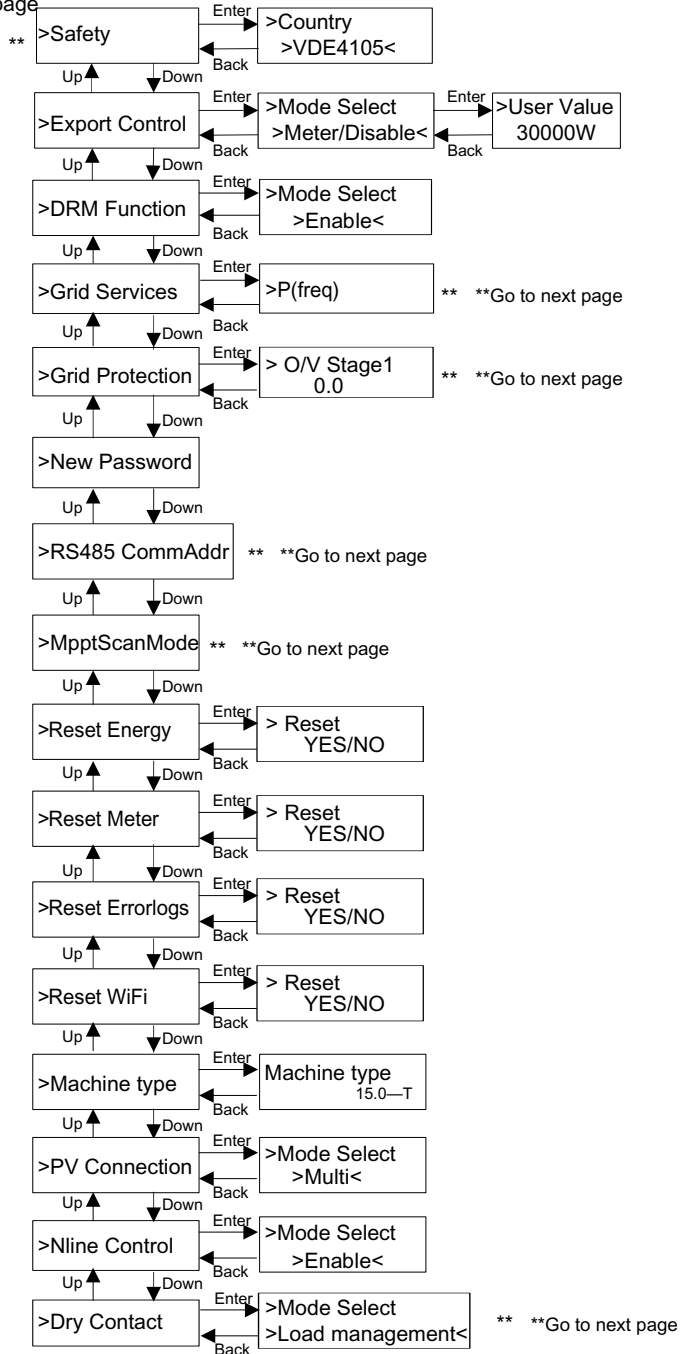

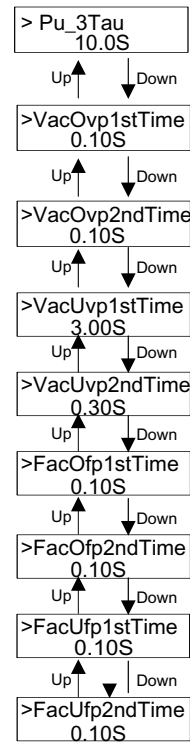
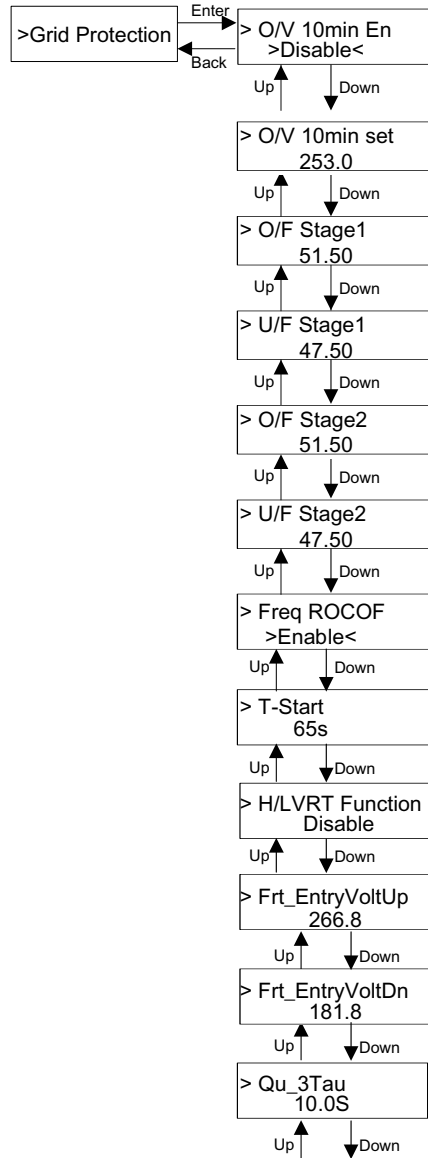

➤ LCD Digital Display

The main interface (Level 1) is the default interface, the inverter will automatically jump to this interface when the system started up successfully or not operated for a period of time. The interface shows the information of "Power", "Pgrid", "Today", "Total". Press "Up" and "Down" to review the information.

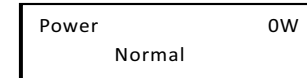

➤ Menu interface

The menu interface (Level 2) is a transfer interface for the user to get into other interface to finish the setting or get the information. -User can get into this interface by long pressing "Down" button when LCD displays the main interface. -User can select by moving the cursor with function button, and long press "Down" to confirm.

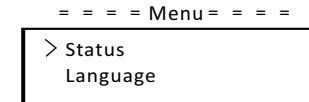

• Status

The status function contains two aspects, the grid and the solar. Press "Up" and "Down" to select and long press "down" to confirm the selection, long press "Up" to return to Menu.

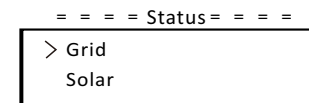

a) Grid

This status shows the current grid condition such as voltage, current, output power and grid power. Pout measures the output of the inverter, Pgrid measures power export to or import from grid. Positive value means the power feeds into grid, negative value means the power used from the grid. Press "Up" and "Down" button to review the parameter, long press "up" to return to Status.

= = = = Grid = = = =

> Ua	0.0V
Ia	0.0A

\*  
\*

b) Solar

This status shows the real time PV condition of the system, such as input voltage, current and power situation of each PV input. Press "Up" and "Down" button to review parameter, long Press "Up" to return to Status.

= = = = Solar = = = =

U1	0.0V
I1	0.0A

\*  
\*

• Language

The function refers to select a language from English, German, Polish, French, Portuguese etc.

= = = = Language = = = =

> English
German

• Date Time

This interface is for the user to set the system date and time. Increase or decrease the word by pressing "Up" or "Down" button. Press "Down" to confirm and alternate to next word. After all the words are confirmed. Long press "Down" to enter the date and time.

= = = =Date Time= = = =

>2021-01-01
00:00

• Settings

Setting function is used for setting the inverter for safety, connection, Grid and so on.

\* Password

The default password is "2014" for the end user, which only allows the user to Review the current setting and some easy setting. If professional change is needed, please contact with the distributor or factory for installer password. We need to increase or decrease the word by pressing up or down button. Press "Down" to confirm an alternate to the next word. After word is confirmed, long press "Down" to enter password.

= = = = Password = = = =

✓
0 0 0 0

When inputting the password, the information of the LCD interface is shown as below.

= = = =Settings = = = =

> Safety
Export Control

a) Safety

The user can set the safety standard here according to different countries and grid tied standards. There are several standards for choice (May change without notice.)

= = = = Safety = = = =

> country
VDE4105

b) Export Control

With this function the inverter can control energy exported to the grid. Whether having this function is based on user's wishes.

Choose "Meter" in "Meter/Disable" means user must install a meter to monitor energy exported to the grid. There are user value and factory value. The factory value is default which can not be changed by user. The user value set by installer must be less than the factory value and within the range of 0 kW to 30 kW.

Choose "Disable" means the function will be shut off.

Press "Up" and "Down" button to select and long press "Down" to confirm.

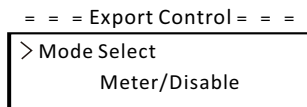

c) DRM Function

Installer can choose "Enable" to control the inverter's power off through the external communication.

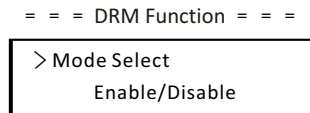

d) Grid Services

Usually end user do not need to set the grid parameters. All default value have been set before leaving factory according to safety rules.

If reset is needed, any changes should be made according to the requirements of local grid.

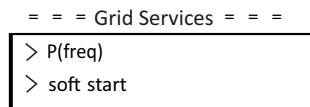

\*  
\*

1. = = = P(freq) = = =

Enable/Disable  
>P(over freq)<

If reset is needed, any changes should be made according to the requirements of local grid.

2. = = = Soft Start = = =

Enable/Disable  
>Disable<

If reset is needed, any changes should be made according to the requirements of local grid.

3.

Soft Start\_Slope  
9%

If reset is needed, 9 percent of the rated power increase per minute.

4-1. = = = Reactive Power = = =

Mode Select  
>Off<

If reset is needed, any changes should be made according to the requirements of local grid.

Mode Select	Comment
Off	-
Over-Excited	PF value
Under-Excited	PF value
PF(P)	Power Factor1(2/3/4)
	Power Ratio1(2/3/4)
	Entry Volt
	Exit Volt
Q(u)	Q(u) Power lock EN
	Q(u) lock IN
	Q(u) lock OUT
	Q(u) GridV1/V2/V3/V4
Fix Q Power	Q Power

4-2. Reactive power control, Reactive standard curve  $\cos \varphi = f(P)$

For VDE ARN 4105, curve  $\cos \varphi = f(P)$  should refer to curve A. Default values of setting are as shown in curve A.  
 For E 8001, curve  $\cos \varphi = f(P)$  should refer to curve B. Default values of setting are as shown in curve B.

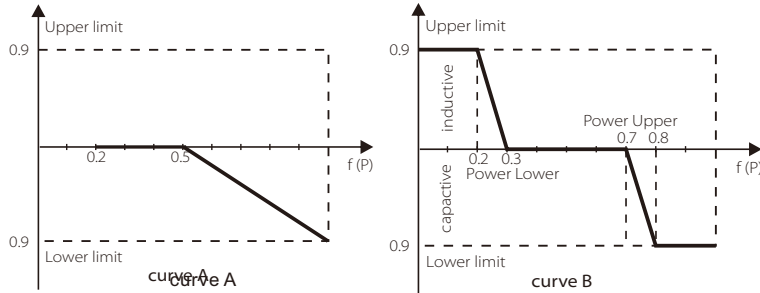

Reactive power control, Reactive standard curve  $Q = f(V)$

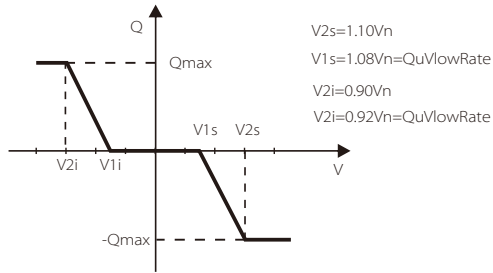

5. = = = P(u) Function = = =

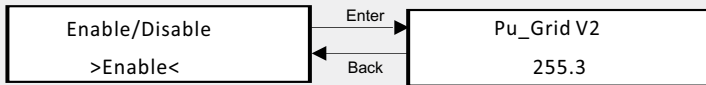

This function can limit the power. There are four values to be set.

6. = = = = Power Limits = = = =

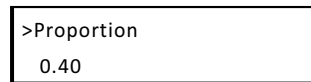

User can set the power limit here, the setting value is from 0.00-1.00.

e) Grid Protection

Usually end user do not need to set the grid Protection. All default value have been set before leaving factory according to safety rules. If reset is needed, any changes should be made according to the requirements of local grid.

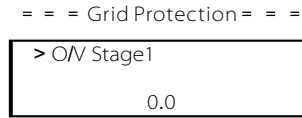

f) New Password

The user can set the new password here. We need to increase or decrease the word by pressing "Up" or "Down" button. Long press "Down" to confirm and alternate to next word. After word is confirmed, long press "Down" to reset the password.

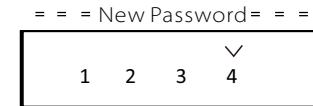

g) RS485 CommAddr

If "enable" is selected, the inverter will communicate with the computer, through which the operating status of the inverter can be monitored. When multiple inverters are monitored by one computer, RS485 communication addresses of different inverters need to be set.



h) Mppt Scan Mode

There are four modes to be selected. "off", "low freq scan", "mid freq scan", "high freq scan". It shows the frequency of PV panel scan.

If "low freq scan" is selected, the inverter will scan the PV panel by low frequency.

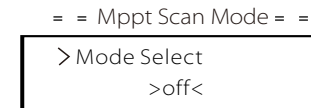

l) Reset Energy

The user can clear the power energy by this function.

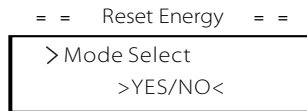

j) Reset Meter

The user can clear the meter energy by this function. Press "Up" or "Down" button to select and long press "Down" to confirm. (The user can select "Yes" to reset meter if the user purchases SolaX meter)

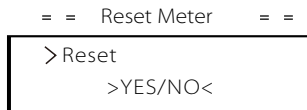

k) Reset Errorlog

The user can clear the errorlogs by this function. Press "Up" or "Down" button to select and long press "Down" to confirm.

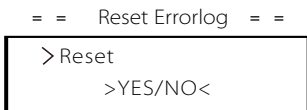

l) Reset WiFi

The user can restart the WiFi by this function.

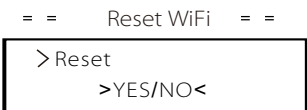

m) Machine Type

The user can check the Machine Type by this function.

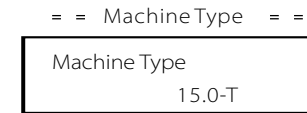

n) PV Connection

The user can select the PV connection type by this function.

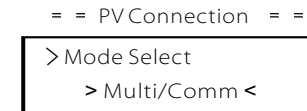

o) Nline Control

The user can enable or disable the Nline Control by this function.

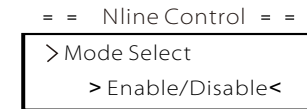

p) Dry Contact

The user can use the Dry Contact to connect heat pump by this function. There are three functions(Disable/Manual/Smart Save) which can be selected for Load Management. "Disable" means the heat pump is off. When "Manual" is selected the user can control the external relay to remain close or open manually. "Smart Save" mode can set the values of the heat pump's on/off time and conditions, operating modes. If the user uses the inverter dry contacts to control heat pump through Adapter box, please refer to the Adapter Box Quick Installation Guide to set the parameters here.

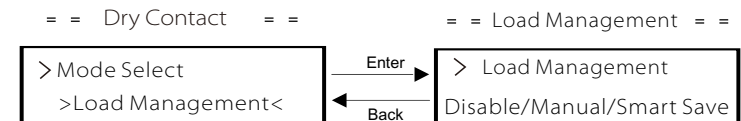



• Meter Energy

The user can check the import and export energy by this function. There are four parameters: "Today Import", "Total Import", "Today Export", "Total Export". Press "Up" and "Down" to review the values.

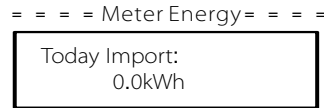

• Error Logs

The Error log contains error information happened. It can record six items at most. Press "Up" and "Down" button to review parameter. Long press "Up" to return to the main interface.

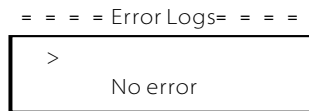

• About

This interface shows information of the inverter, include product SN, master, manager and Internal Code.

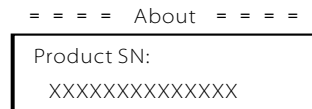

## 7. Troubleshooting

### 7.1 Trouble shooting

This section contains information and procedures for solving possible problems with X3-MIC G2 series inverters, and provides you with troubleshooting tips to identify and solve most problems that could occur with the X3-MIC G2 series inverters.

This section will help you narrow down the source of any problems you may encounter. Please read the following troubleshooting steps. Check warnings or fault messages on System Control Panel or Fault codes on the inverter information panel. If a message is displayed, record it before doing anything further.

Attempt the solution indicated in below table.

Faults	Diagnosis and Solution
TzFault	Over Current Fault. -Wait for about 10 seconds to check if the inverter is back to normal. -Disconnect the DC switch and restart the inverter. -Or seek help from us.
GridLostFault	Grid Lost Fault. -Check if the mains cable is loose. -Wait for a while and the system will reconnect when the utility is back to normal.
GridVoltFault	Grid Voltage Out of Range. -Check if the mains cable is loose. -Wait for a while and the system will reconnect when the utility is back to normal.
GridFreqFault	Grid Frequency Out of Range. -Wait for a while and the system will reconnect when the utility is back to normal.
PvVoltFault	PV Voltage Fault. -Check whether the PV is overvoltage. -Or seek help from us.
BusVoltFault	DC Bus Voltage Out of Normal Range. -Check if the PV input voltage is within the operating range of the inverter. -Disconnect PV wiring and reconnect. -Or seek help from us.
GridVolt10MFAult	Grid Overvoltage for Ten Minutes Fault. -The system will reconnect when the utility is back to normal. -Or seek help from us.
DcljOcp	DCI Overcurrent Protection Fault. -Wait for a while to check if the inverter is back to normal. -Or seek help from us.
HardLimitFault	Hard Limit Fault (in Australian standard). -Wait for a while to check if the inverter is back to normal. -Or seek help from us.
SW OCP Fault	Software Overcurrent Protection Fault. -Wait for a while to check if the inverter is back to normal. -Disconnect PV and grid, then reconnect. -Or seek help from us.

Faults	Diagnosis and Solution
ResidualOcp	Overcurrent Protection Fault. -Check the connections of the inverter. -Wait for a while to check if the inverter is back to normal. -Or seek help from us.
IsoFault	Isolation Fault. -Check the connections of the inverter. -Or seek help from us.
OverTempFault	Over Temperature Fault. -Check if the inverter and the ambient temperature exceeds the operating range.
LowTempFault	Low Temperature Fault. -Check if the ambient temperature is too low. -Or seek help from us.
InternalComFault	Internal Communication Fault. -Restart the inverter to check if it is back to normal. -Update the ARM software or reburn the program. -Or seek help from us.
FanFault	Fan Fault. -Check whether the fan is faulty or damaged. -Or seek help from us.
AcTerminalOTP	AC Terminal Overtemperature Fault. -Check if the AC terminals are tightly connected. -Check if the ambient temperature exceeds the operating range. -Or seek help from us.
EepromFault	DSP EEPROM Fault. -Disconnect PV wiring and reconnect. -Or seek help from us.
RcDeviceFault	Residual Current Device Fault. -Restart the inverter. -Update the ARM software or reburn the program. -Or seek help from us.
PvConnDirFault	PV Direction Fault. -Check if the PV+/- sides are connected correctly. -Or seek help from us.
GridRelayFault	Relay Fault. -Check the grid connection. -Restart the inverter. -Or seek help from us.
OtherDeviceFault	Model Incorrectly Set Fault. -Seek help from us.
Mgr EEPROM Fault	ARM EEPROM Fault. -Disconnect PV and grid, then reconnect. -Or seek help from us.
Meter Fault	Meter Fault. -Check the connection of the meter. -Check if the meter is in working order. -Or seek help from us.
Fan1 Warning	External Fan 1 Abnormal Warning. -Check if the fan is working. -Or seek help from us.
Fan2 Warning	External Fan 2 Abnormal Warning. -Check if the fan is working. -Or seek help from us.

- If the information panel of your inverter does not show the Fault light, check the following list to make sure that the present state of the installation allows proper operation of the unit.
  - Is the inverter located in a clean, dry, adequately ventilated place?
  - Have the DC input breakers been opened?
  - Are the specification and length of the cables suitable?
  - Are the input and output connections and wiring in good condition?
  - Are the configuration settings correct for your particular installation?

Contact SolaX Customer Service for further assistance. Please be prepared to describe details of your system installation and provide model and serial number of the inverter.

### 7.2 Routine maintenance

Inverters do not need any maintenance or correction in most cases, but if the inverter often loses power due to overheating, this can be attributed to the following reason:

- The cooling fins on the rear of the inverter are covered by dirt. Clean the cooling fins with a soft dry cloth or brush if necessary. Only trained and authorized professional personnel who are familiar with the requirements of safety was allowed to perform servicing and maintenance work.

#### ► Safety checks

Safety checks should be performed at least every 12 months by manufacturer's qualified person who has adequate training, knowledge, and practical experience to perform these tests. The data should be recorded in an equipment log. If the device is not functioning properly or fails any of test, the device has to be repaired. For safety check details, refer to this manual, section 2 Safety instruction and EC Directives.

#### ► Maintain periodically

Only qualified person may perform the following works. During the process of using the inverter, the manage person shall examine and maintain the machine regularly. The concrete operations are as follows.

1. Check that if the cooling fins on the rear of the inverter are covered by dirt, and the machine should be cleaned and absorbed dust when necessary. This work shall be performed from time to time.
2. Check that if the indicators of the inverter are in normal state, check if the keys of the inverter are in normal state, check if the display of the inverter is normal. This check should be performed at least every 6 months.
3. Check that if the input and output wires are damaged or aged. This check should be performed at least every 6 months.
4. Clean the inverter panels and check their security. This should be carried out at least every 6 months.

## 8. Decommissioning

### 8.1 Dismantling the Inverter

- Disconnect the inverter from DC Input and AC output.
- Wait for at least 5 minutes for de-energizing.
- Disconnect communication and optional connection wirings.
- Remove the inverter from the bracket.
- Remove the bracket if necessary.



#### **WARNING !**

Only dismantle the inverter after it is powered off for at least 5 minutes, otherwise there is a risk of electric shock!

### 8.2 Packaging

If possible, please pack the inverter with the original packaging.

If it is no longer available, you can also use an equivalent carton that meets the following requirements.

- Suitable for loads more than 30 kg.
- Can be fully closed.

### 8.3 Storage and Transportation

Store the inverter in dry place where ambient temperatures are always between  $-30^{\circ}\text{C}$  ~  $+60^{\circ}\text{C}$ . Keep less than 6 cartons in one stack during the storage and transportation.

### 8.4 Waste Disposal

When the inverter or other related components need to be disposed, have it carried out according to local waste handling regulations. Please be sure to deliver wasted inverters and packing materials to certain site where can assist relevant department to dispose and recycle.

## 9. Disclaimer

The X3-MIC G2 series inverters are transported, used and operated under limited condition, such as environmental, electrical etc. SolaX shall not be liable to provide the service, technical support or compensation under conditions listed below, including but not limited to:

- . Inverter is damaged or broken by force majeure (such as earthquake, flooding, thunderstorm, lighting, fire hazard, volcanic eruption etc.).
  - . Inverter's warranty is expired and doesn't buy extended warranty.
  - . Can't provide the inverter's SN, warranty card or invoice.
  - . Inverter is damaged by man-made cause.
  - . Inverter is used or operated against any items in local policy.
  - . Inverter's installation, configuration, commissioning doesn't follow the requirements mentioned in this manual.
  - . Inverter is installed, refitted or operated in improper ways mentioned in this manual without authority from SolaX.
  - . Inverter is installed, operated under improper environment or electrical condition mentioned in this manual without authority from SolaX.
  - . Inverter is changed, updated or disassembled on hardware or software without authority from SolaX .
  - . Obtain the communication protocol from other illegal channels.
  - . Build monitoring, control system without authority from SolaX.
- SolaX will keep right to explain all the contents in this user manual.

# Warranty Registration Form



## For Customer (Compulsory)

Name ..... Country .....

Phone Number ..... Email .....

Address .....

State ..... Zip Code .....

Product Serial Number .....

Date of Commissioning .....

Installation Company Name .....

Installer Name ..... Electrician License No. ....

## For Installer

### Module ( If Any )

Module Brand .....

Module Size(W) .....

Number of String ..... Number of Panel Per String .....

### Battery ( If Any )

Battery Type .....

Brand .....

Number of Battery Attached .....

Date of Delivery ..... Signature .....

Please visit our warranty website: <https://www.solaxcloud.com/#/warranty> to complete the online warranty registration or use your mobile phone to scan the QR code to register.

For more detailed warranty terms, please visit SolaX official website: [www.solaxpower.com](http://www.solaxpower.com) to check it.





PLEASE REGISTER THE WARRANTY IMMEDIATELY AFTER INSTALLATION!  
GET YOUR WARRANTY CERTIFICATE FROM SOLAX!  
KEEP YOUR INVERTER ONLINE & WIN SOLAX POINTS!

1

Open your camera app and point your device at the QR code



2

Wait for the camera to recognize the QR code



3

Click banner or notification when it appears on the screen



4

Warranty registration page will be loaded automatically

