



## MANUAL/INSTALLATION INSTRUCTIONS

Automatic Transfer Switch for the SMA Flexible Storage System with  
Battery Backup Function

for Sunny Boy Storage 3.7/5.0/6.0



prepared for the installation of Energy Meter/Home Manager 2.0

## TABLE OF CONTENTS

|       |   |    |
|-------|---|----|
| 1.    | About this guidance.....  | 4  |
| 1.1   | Scope of application .....  | 4  |
| 1.2   | Target group .....  | 5  |
| 1.3   | Symbols used .....  | 5  |
| 2.    | Safety.....   | 6  |
| 2.1   | Appropriate use .....   | 6  |
| 2.2   | Automatic transfer switch - Model Nos. 10012945/10012856.....                 | 7  |
| 2.3   | Safety instructions.....  | 7  |
| 2.4   | Explanation of the symbols used/Characteristic values on the name plate ..... | 8  |
| 3.    | Scope of delivery .....   | 9  |
| 3.1   | Model No. 10012945 .....  | 9  |
| 3.2   | Model No. 10012856.....   | 10 |
| 4.    | Electrical connection .....   | 11 |
| 4.1   | Installing the Energy Meter/Home Manager .....                                | 11 |
| 4.2   | Wiring diagrams.....  | 12 |
| 4.2.1 | Circuit diagram - Model No. 10012945 .....                                    | 12 |
| 4.2.2 | Schematic - Model No. 10012945 .....  | 13 |
| 4.2.3 | Circuit diagram - Model No. 10012856 .....                                    | 14 |
| 4.2.4 | Schematic - Model No. 10012856 .....  | 15 |
| 5.    | Mounting the Battery Backup Distribution .....                                | 16 |
| 5.1   | Selecting the mounting location.....  | 16 |
| 5.2   | Installation clearances .....   | 17 |
| 5.3   | Dimensions and cable entries.....   | 18 |
| 5.3.1 | Dimensions and mounting.....  | 18 |
| 5.3.2 | Cable entry and conductor cross sections - Model No. 10012945.....            | 19 |
| 5.3.3 | Cable entry and conductor cross sections - Model No. 10012856.....            | 20 |
| 6.    | Connection area - terminal arrangement.....                                   | 21 |
| 6.1   | Power connection - Model No. 10012945.....                                    | 21 |
| 6.2   | Power connection - Model No. 10012856.....                                    | 22 |
| 6.3   | Connection SMA Backup Controller .....  | 23 |
| 7.    | AC wiring.....  | 24 |

|       |   |    |
|-------|---|----|
| 7.1   | Connection to the grid supply/public grid.....  | 24 |
| 7.2   | Connection to the building's distribution box (low-voltage main distribution) - consumers ..... | 25 |
| 7.3   | Connecting the Sunny Boy Storage battery inverter.....  | 26 |
| 7.4   | Connecting the PV inverter(s) .....   | 27 |
| 7.4.1 | Combination options - PV inverters .....  | 28 |
| 7.4.2 | Connecting a PV-generation meter .....  | 29 |
| 8.    | Connecting the Home Manager/Energy-Meter .....  | 29 |
| 9.    | Phase coupling.....   | 30 |
| 10.   | Commissioning the automatic transfer switch and backup power system .....                       | 31 |
| 11.   | Troubleshooting .....   | 32 |
| 12.   | Disconnecting the power supply to the automatic transfer switch .....                           | 36 |
| 13.   | Maintenance and Cleaning.....   | 37 |
| 14.   | Storage.....  | 38 |
| 15.   | Disposal.....   | 38 |
| 16.   | Technical data:.....  | 39 |
| 16.1  | Model No. 10012945.....   | 39 |
| 16.2  | Model No. 10012856.....   | 40 |
| 17.   | Disclaimer .....  | 41 |
| 18.   | Manufacturer's declaration of conformity with EU regulations .....                              | 42 |

# 1. About this guidance

## 1.1 Scope of application

The following instructions are valid for all enwitec electronic GmbH & Co. KG produced “Battery Backup Distributions”, used in accordance with the recommendations of

**SMA Solar Technology AG - Sonnenallee 1 in 34266 Niestetal - Deutschland**

In addition to this installation manual, it is essential that you also read and follow the relevant SMA documentation and installation instructions for Sunny Boy Storage 3.7/5.0/6.0 at [www.sma.de](http://www.sma.de)

Type designations (enwitec electronic - matchcode) for Battery Backup Distributions

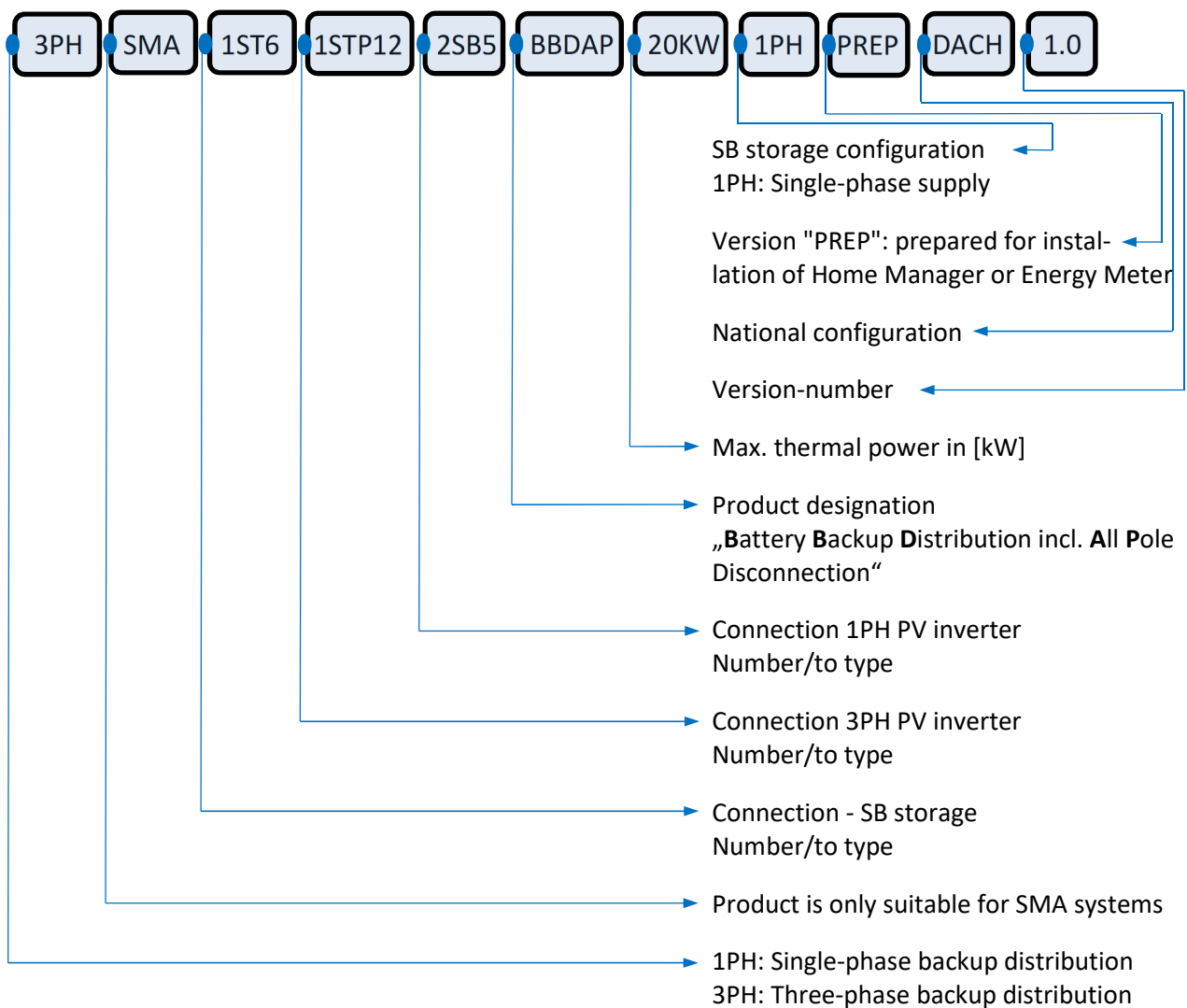

## 1.2 Target group

This manual is for qualified electricians. The activities described in this manual must only be performed out by qualified electricians.

## 1.3 Symbols used



"Danger" indicates safety advice which, if not observed, will result immediately in death or severe personal injury!



"Warning" indicates safety advice which, if not observed, may result in death or severe personal injury!



"Caution" indicates safety advice which, if not observed, may result in light or medium personal injury!



"Attention" indicates safety advice which, if not observed, may result in material damage!



"Qualified electrician" indicates work that may only be performed by a certified electrician.



"Info" indicates important information!

## 2. Safety

### 2.1 Appropriate use

- The „Battery Backup Distribution“ is an automatic transfer switch, suitable to the SMA „Flexible Storage System“, functionally in communicating to:
  - Sunny Boy Storage SBS 3.7-10
  - Sunny Boy Storage SBS 5.0-10
  - Sunny Boy Storage SBS 6.0-10
- optionally in conjunction with:
  - HM-20 (Sunny Home Manager 2.0)
  - or
  - EMETER-20 (SMA Energy Meter)

In the event of failure of the mains power supply, the Battery Backup Distribution undertakes a safe, all-pole disconnection of the battery inverter, the PV inverter(s) and the connected loads from the public power grid and forms a backup power supply. The backup power supply is used to supply consumers, which should continue to be supplied if the public power supply fails. The Sunny Boy Storage supplies the consumers with power after a short switchover time. The PV system\* provides additional power that can be used to supply the consumers and charge the battery.

The automatic transfer switch is designed for the connection of SMA solar inverters. If you wish to use PV inverters from other manufacturers, you should consult the system manufacturer SMA regarding the suitability of these products before using them.

The Battery Backup Distribution is suitable for use in both TT and TN-S systems.

This product is only suitable for use in indoor or protected outdoor areas (no direct exposure to weather and sunlight, no condensation)!

Basically, you can only operate the Battery Backup Distribution in conjunction with one of the above mentioned battery inverters from SMA. The detailed instructions for system integration can be found in the currently valid system documentation from SMA (see [www.sma.de](http://www.sma.de))

The Sunny Boy Storage battery inverter coordinates all switching operations and controls the contactors of the Battery Backup Distribution in conjunction with the installed SMA Backup Controller. The communication between the Sunny Boy Storage and the SMA Backup Controller takes place via a CAN bus.

The maximum connection power must not be exceeded. In this regard, please note the permissible values of the Battery Backup Distribution in the technical data (Chapter 16).

This manual is part of the Battery Backup Distribution. Keep the manual accessible at all times.

\* not when using a 3PH-PV inverter

## 2.2 Automatic transfer switch - Model Nos. 10012945/10012856

The automatic transfer switch is available in two versions, which differ only in their PV inverter connections. In this regard, please refer to chapter 7.4.1. Here are the different combinations of PV inverters, but these do not have to be connected in the automatic transfer switch.

Model No. **10012945**

- two single phase PV-inverters  
(= maximum backup power support)

Model No. **10012856**

- two single phase PV-inverters  
(= maximum backup power support)
- one three-phase PV inverter up to 12KVA
- PV meter can be integrated



### Three-phase PV inverter

- Mains parallel operation only
- **NO** backup power mode support

## 2.3 Safety instructions



Danger to life due to high voltages! The installation and commissioning of the Battery Backup Distribution must only be carried out by qualified electricians! These technicians must have the following qualifications:

- Training in dealing with hazards and risks during the installation, repair and operation of electrical equipment and systems
- Training in the installation and commissioning of electrical equipment and systems
- Knowledge of relevant laws, standards and guidelines
- Knowledge and observance of this document, including all safety instructions











The product is not suitable for the supply of life-sustaining medical devices!



Do not use the Battery Backup Distribution for purposes other than those described here. Deviating uses, conversions and other changes invalidate all warranty claims and the operating license.

The Battery Backup Distribution is designed in such a way that the safety devices (circuit breaker and residual current circuit breaker) can be operated by a non-specialist. In addition, various operating states can be read (by the non-specialist) on the SMA Energy Meter (or Home Manager) by means of LEDs. In this respect, please also note SMA's original installation instructions for the Energy Meter (or Home Manager)!

## 2.4 Explanation of the symbols used/Characteristic values on the name plate

| Symbol   | Designation/Meaning   |
|--|---|
|                 | Do not dispose of Battery Backup Distribution and its components in the household waste!  |
|                 | <b>CE symbol</b><br>The Battery Backup Distribution meets the requirements of the applicable EU guidelines  |
|                 | <b>Protection class II</b><br>The Battery Backup Distribution has reinforced insulation and is thus protected against direct and indirect contact.  |
| <br>No symbol   | <b>Protection rating IP65/IP44</b><br>The Battery Backup Distribution is completely protected against dust ingress and water jets OR (IP44) protected against solid foreign bodies with a diameter $\geq 1,0$ mm/water spray from all directions  |
| <br>No symbol | <b>Max. ambient temperature (<math>t_a</math>) [°C]</b><br>The Battery Backup Distribution can be operated up to this max. ambient temperature.   |
| <br>No symbol | <b>Rated operating voltage [V]</b><br>Do not operate the Battery Backup Distribution on any other operating voltage than that specified!  |
| <br>No symbol | <b>Rated operating frequency [Hz]</b><br>Do not operate the Battery Distribution on any other operating frequency than that specified!  |
| <br>No symbol | <b>Rated power [kW]</b><br>The Battery Backup Distribution is designed for this throughput or thermal rating.   |
| <br>No symbol | <b>Peak current [A]</b><br>The Battery Backup Distribution can be operated up to this max. peak current.  |
| <br>No symbol | <b>IEC/EN standard specification</b><br>The Battery Backup Distribution meets<br>IEC/EN 61439-1 "Low-voltage switchgear and control gear assemblies"<br>IEC/EN 61439-2 "Power switchgear and control gear assemblies"<br>IEC/EN 61439-3 "Distribution boards intended to be operated by ordinary persons (DBO)" |



### 3. Scope of delivery

#### 3.1 Model No. 10012945

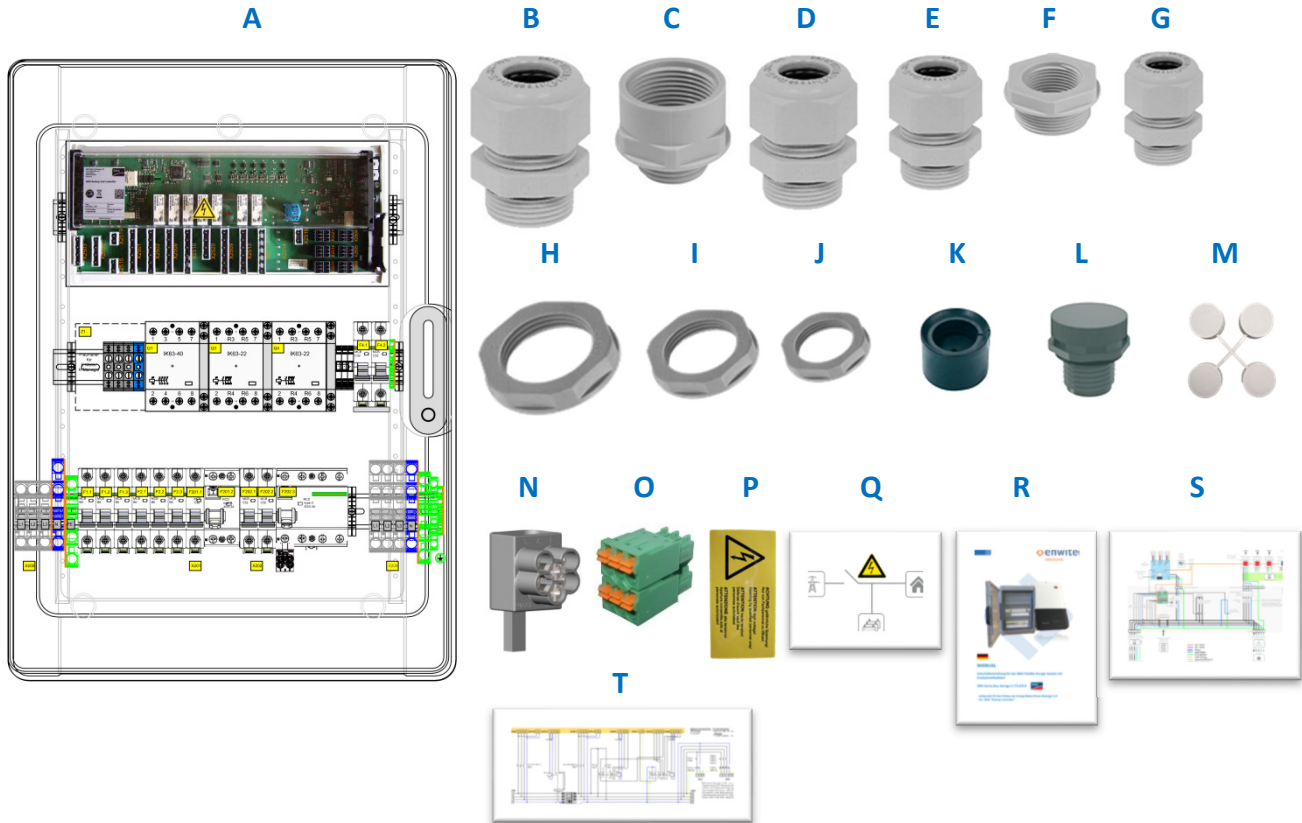

| Position | Number | Component   |
|----------|--------|---|
| A        | 1      | Battery Backup Distribution 10012945                                |
| B        | 2      | Cable gland M40 x 1.5 (clamping range $\varnothing$ 16 - 28mm)      |
| C        | 2      | Enlargement adaptor from M32 to M40                                 |
| D        | 2      | Cable gland M32 x 1.5 (clamping range $\varnothing$ 13 - 21mm)      |
| E        | 4      | Cable gland M25 x 1.5 (clamping range $\varnothing$ 9 - 17mm)       |
| F        | 1      | Reduction adaptor from M20 to M12 (for pressure compensation valve) |
| G        | 3      | Cable gland M20 x 1.5 (clamping range $\varnothing$ 6 - 13mm)       |
| H        | 2      | Lock nut M32  |
| I        | 4      | Lock nut M25  |
| J        | 3      | Lock nut M20  |
| K        | 1      | Special sealing insert for CAT 5e cable (M25)                       |
| L        | 1      | Pressure compensation element                                       |
| M        | 1      | Cover caps for mounting screws                                      |
| N        | 1      | N-supply terminal 3-fold (mounted on the FI)                        |
| O        | 1      | Communication plug (plugged into the backup controller - X2504)     |
| P        | 1      | Warning label "Dangerous Voltage"                                   |
| Q        | 1      | Label - Indicates a stand-alone storage system                      |
| R        | 1      | Installation manual (this document)                                 |
| S        | 1      | Schematic (DIN A3 printout)   |
| T        | 1      | Circuit diagram (DIN A3 printout)                                   |

### 3.2 Model No. 10012856

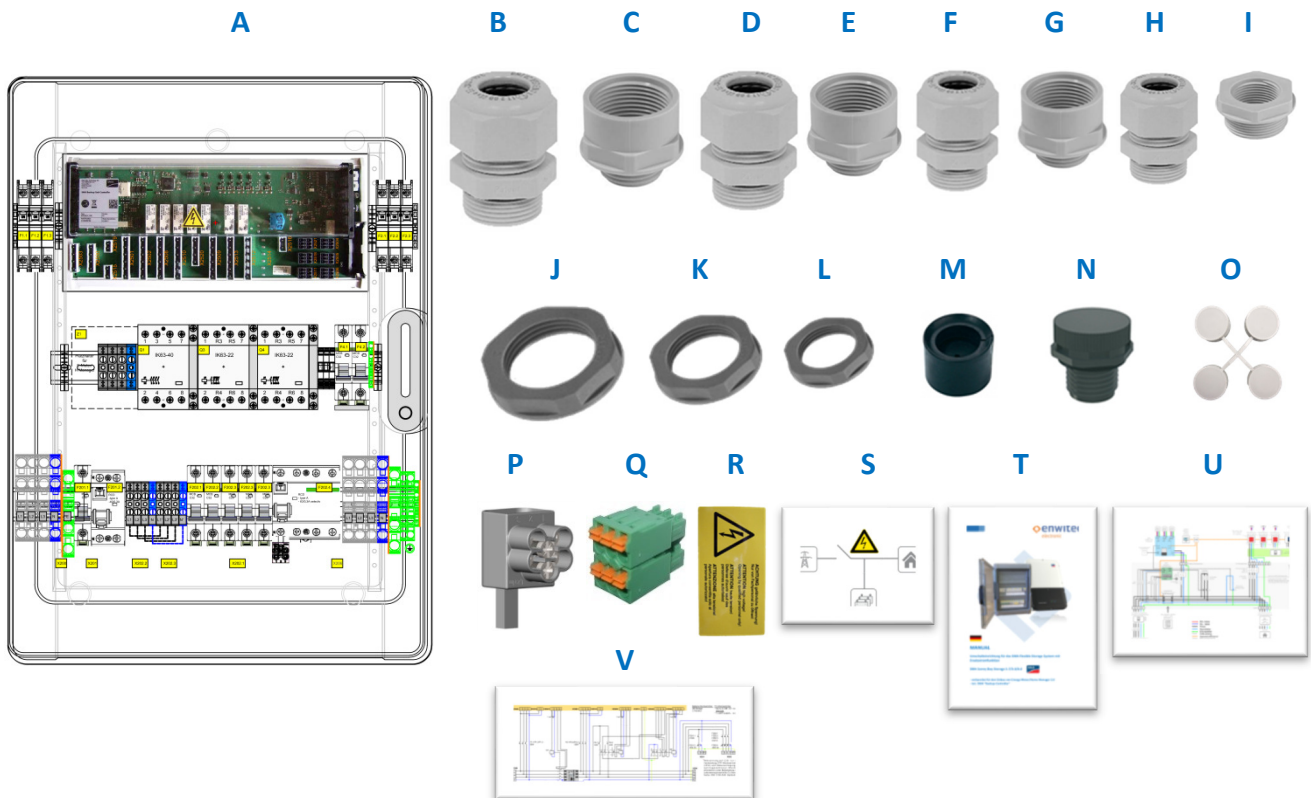

| Position | Number | Component   |
|----------|--------|---|
| A        | 1      | Battery Backup Distribution 10012856                                |
| B        | 2      | Cable gland M40 x 1.5 (clamping range $\varnothing$ 16 - 28mm)      |
| C        | 2      | Enlargement adaptor from M32 to M40                                 |
| D        | 5      | Cable gland M32 x 1.5 (clamping range $\varnothing$ 13 - 21mm)      |
| E        | 2      | Enlargement adaptor from M25 to M32                                 |
| F        | 4      | Cable gland M25 x 1.5 (clamping range $\varnothing$ 9 - 17mm)       |
| G        | 2      | Enlargement adaptor from M20 to M25                                 |
| H        | 2      | Cable gland M20 x 1.5 (clamping range $\varnothing$ 6 - 13mm)       |
| I        | 1      | Reduction adaptor from M20 to M12 (for pressure compensation valve) |
| J        | 3      | Lock nut M32  |
| K        | 4      | Lock nut M25  |
| L        | 5      | Lock nut M20  |
| M        | 1      | Special sealing insert for CAT 5e cable (M25)                       |
| N        | 1      | Pressure compensation element                                       |
| O        | 1      | Cover caps for mounting screws                                      |
| P        | 1      | N-supply terminal 3-fold (already mounted on the FI)                |
| Q        | 1      | Communication plug (plugged into the backup controller - X2504)     |
| R        | 1      | Warning label "Dangerous Voltage"                                   |
| S        | 1      | Label - Indicates a stand-alone storage system                      |
| T        | 1      | Installation manual (this document)                                 |
| U        | 1      | Schematic (DIN A3 printout)   |
| V        | 1      | Circuit diagram (DIN A3 printout)                                   |

## 4. Electrical connection

### 4.1 Installing the Energy Meter/Home Manager



Instead of the Energy Meter / Home Manager, screw terminals are used as placeholders.

An Energy Meter / Home Manager is not included in the scope of delivery and must be retrofitted!

The terminals are capable of carrying currents, whereby the basic function of the automatic transfer switch is given. Thus, the automatic transfer switch can already be connected and tested without Energy Meter / Home Manager.

During installation, note the positioning of the Energy Meter / Home Manager to the cover strips of the distribution board.

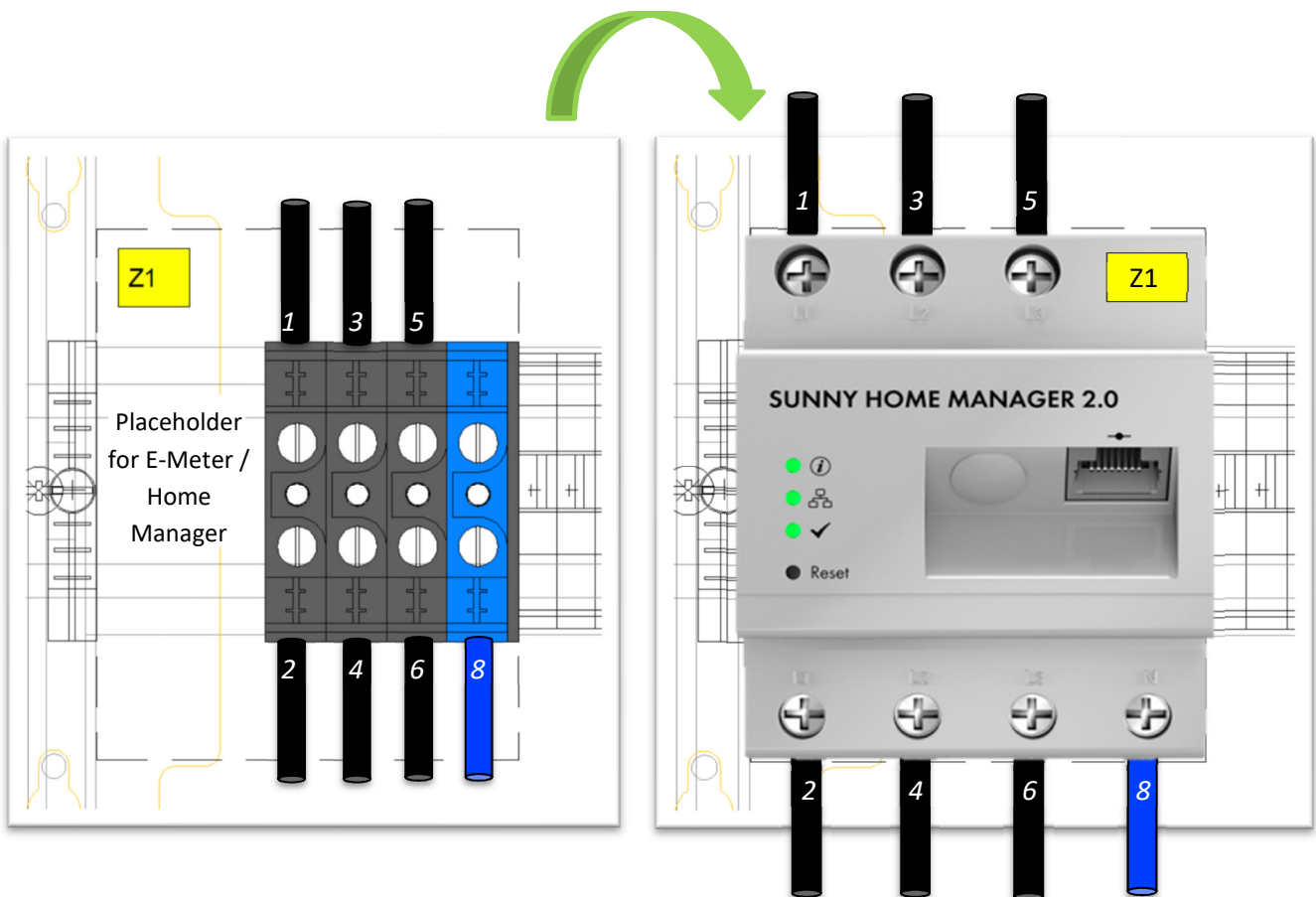

When installing the Energy Meter / Home Manager, observe the **maximum permissible torque of 2.0 Nm!**

## 4.2 Wiring diagrams

### 4.2.1 Circuit diagram - Model No. 10012945

Connection PV inverter

Connection - SB storage

Earthing device

Phase coupling

Supply separation

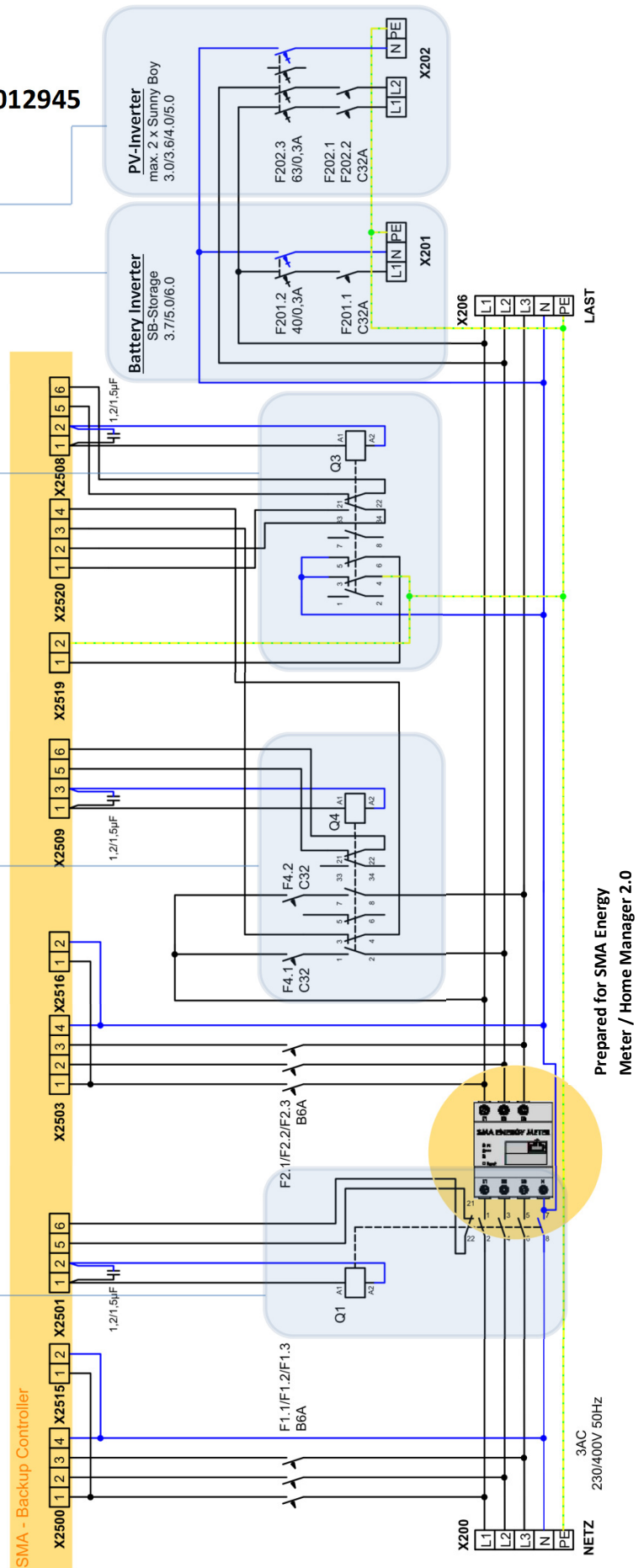

### 4.2.2 Schematic - Model No. 10012945

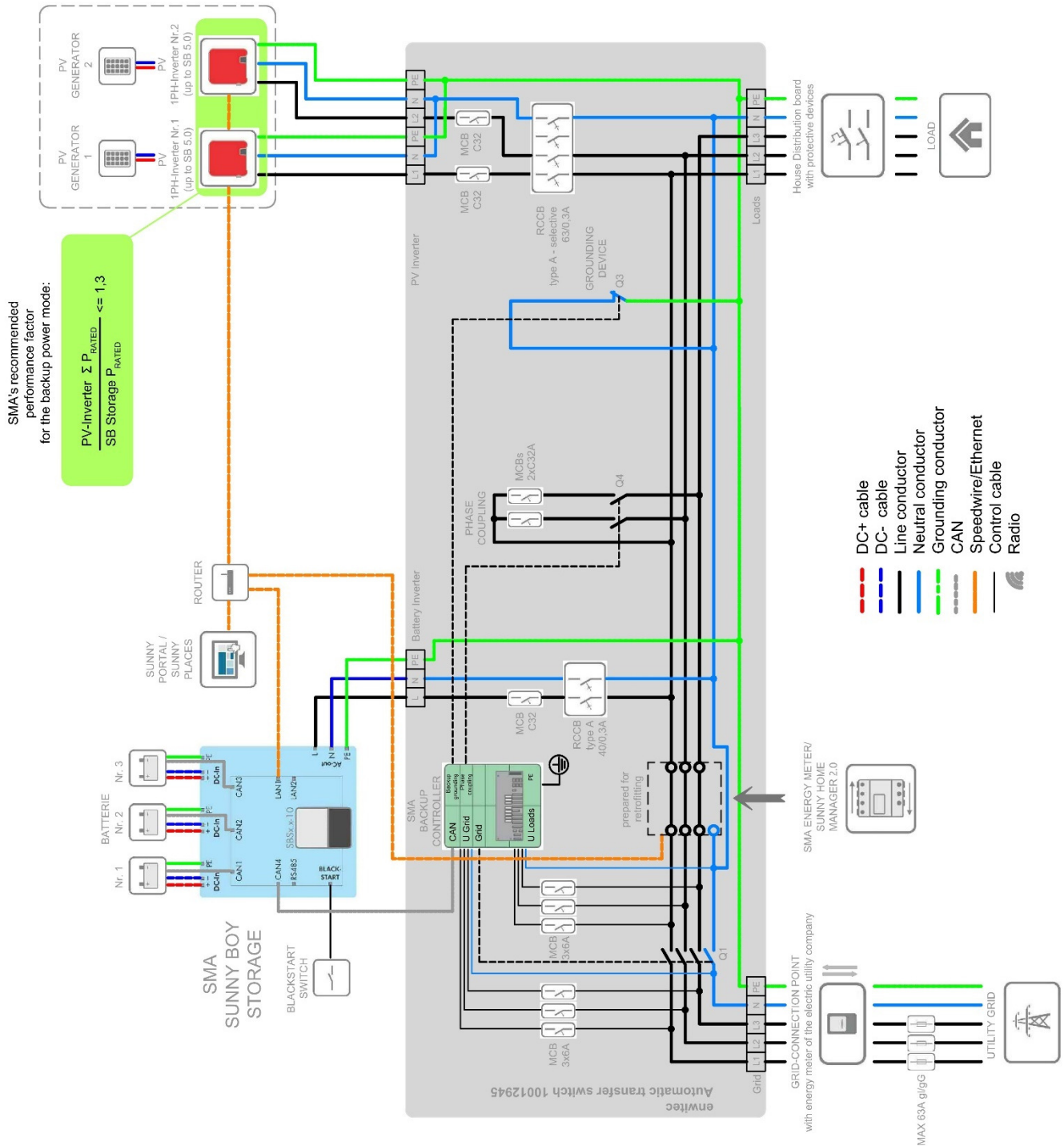

### 4.2.3 Circuit diagram - Model No. 10012856

Connection option - PV generation meter

Connection PV inverter

Connection - SB storage

Earthing device

Phase coupling

Supply separation

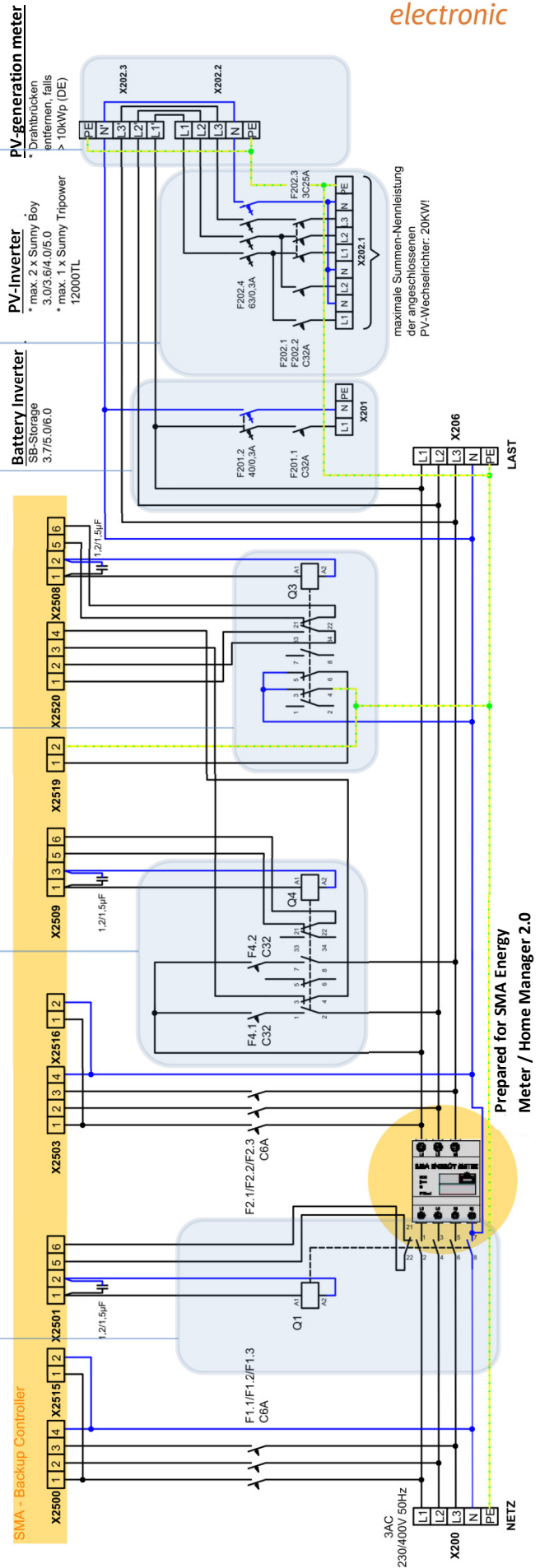

### 4.2.4 Schematic - Model No. 10012856

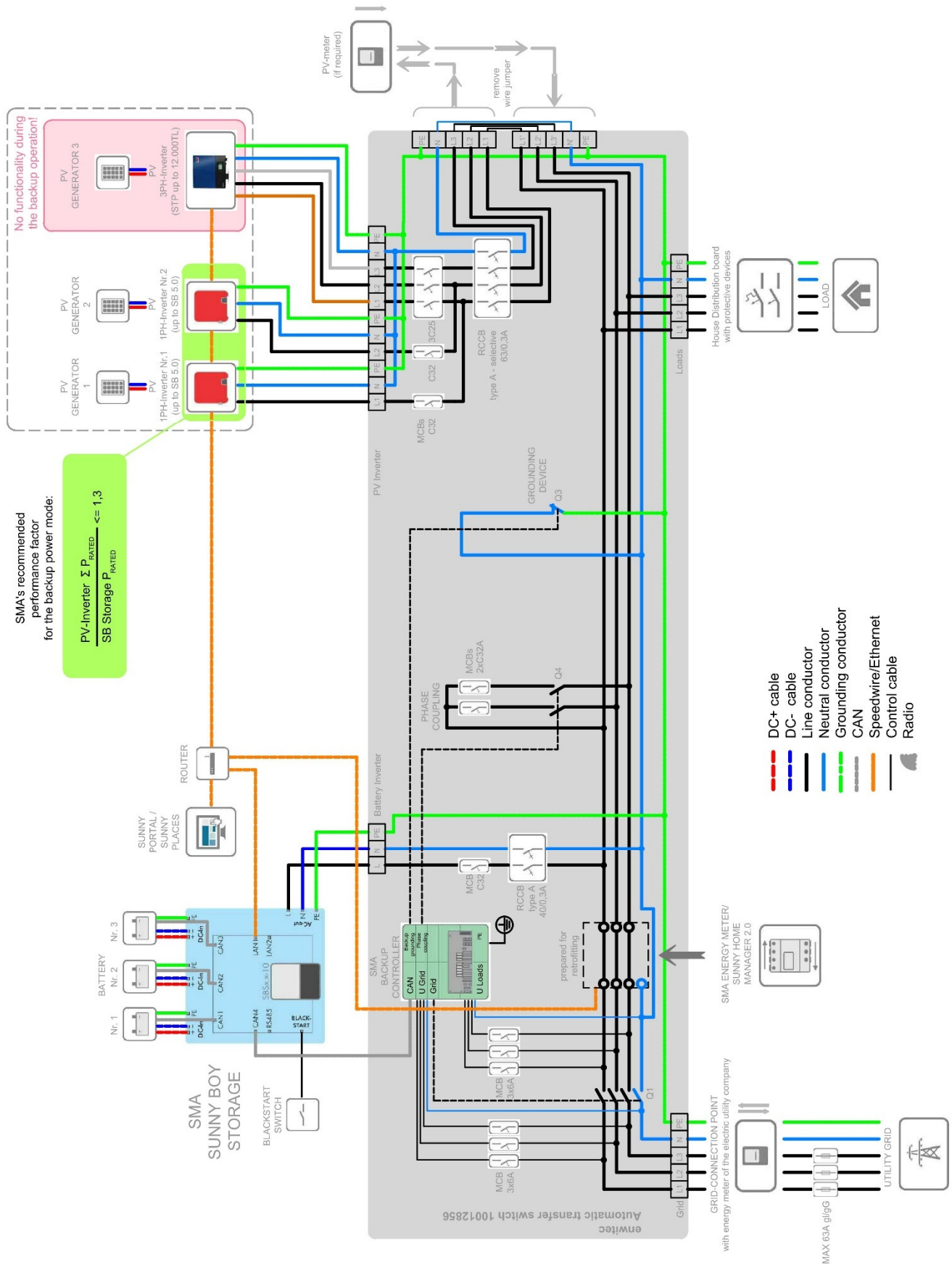

## 5. Mounting the Battery Backup Distribution

### 5.1 Selecting the mounting location

#### DANGER

**risk of explosion or fire during the installation of the device in nonpermissible areas, death or serious burns. Despite careful engineering, electrical devices can cause fires!**

- Do not mount the device on flammable construction materials.
- Do not mount the device near highly flammable materials.
- Do not mount the device in potentially explosive areas.

- Mount on a solid surface
- The mounting location and method must be suitable for the weight and dimensions
- The mounting location must be accessible at all times!
- climatic conditions must be in compliance to the specification (Look at chapter -16-)
- The device may not be exposed to direct sunlight and weathering!
- The mounting location has to be protected against splashing water!
- You have to fulfil the requirements of the network operator!

#### Installation position

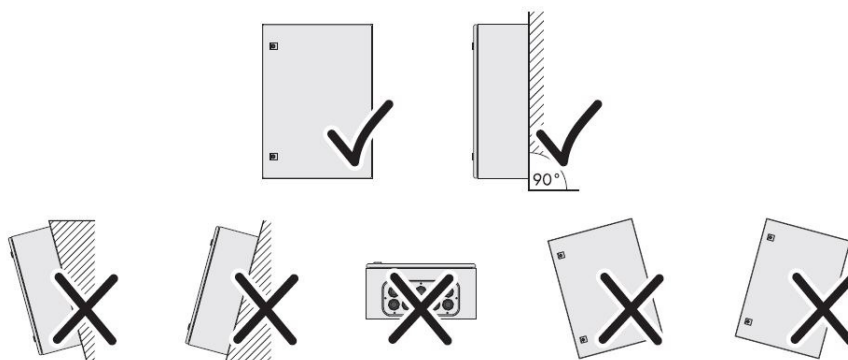



## 5.2 Installation clearances

**i** Minimum distances

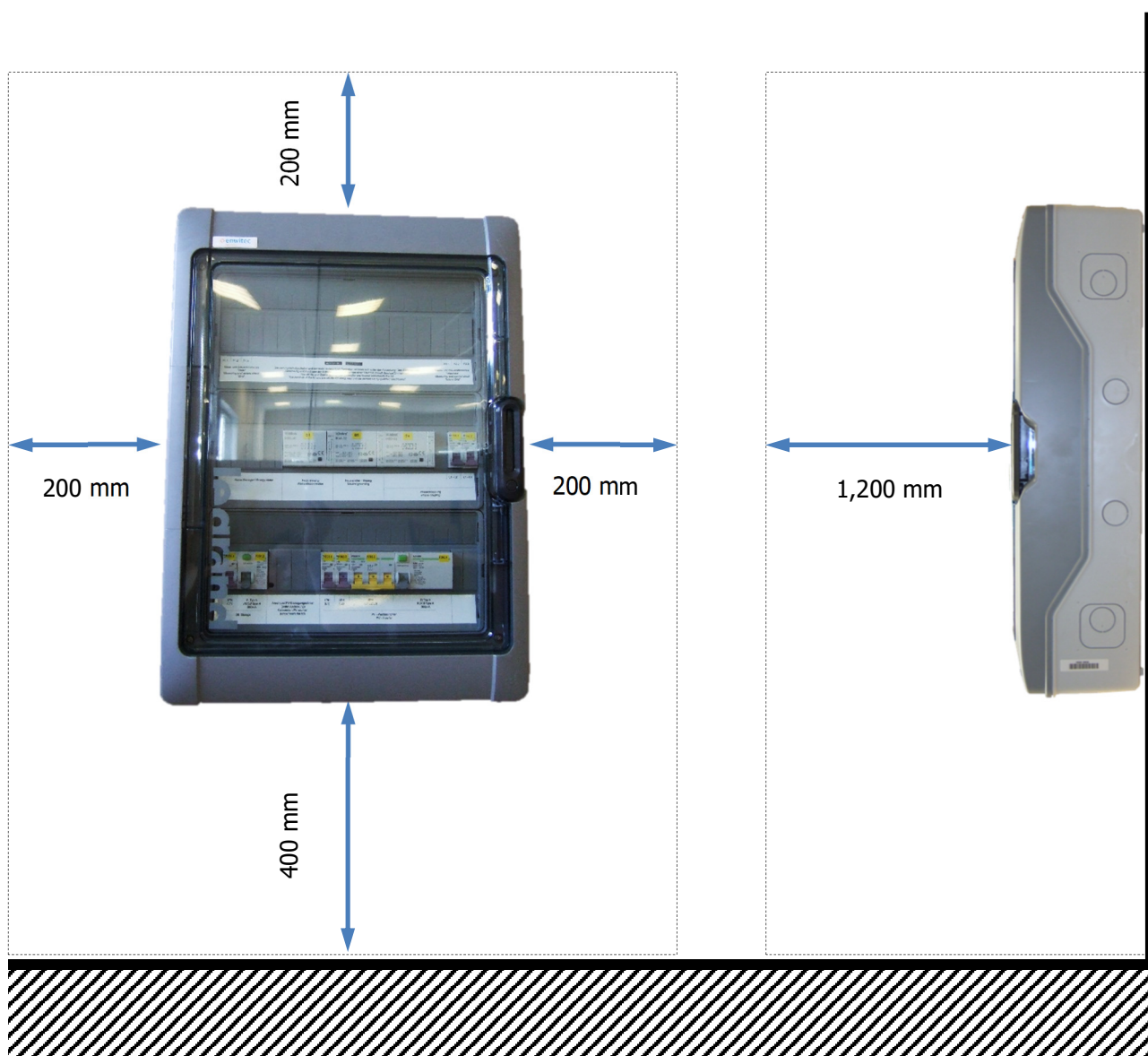

## 5.3 Dimensions and cable entries

### 5.3.1 Dimensions and mounting

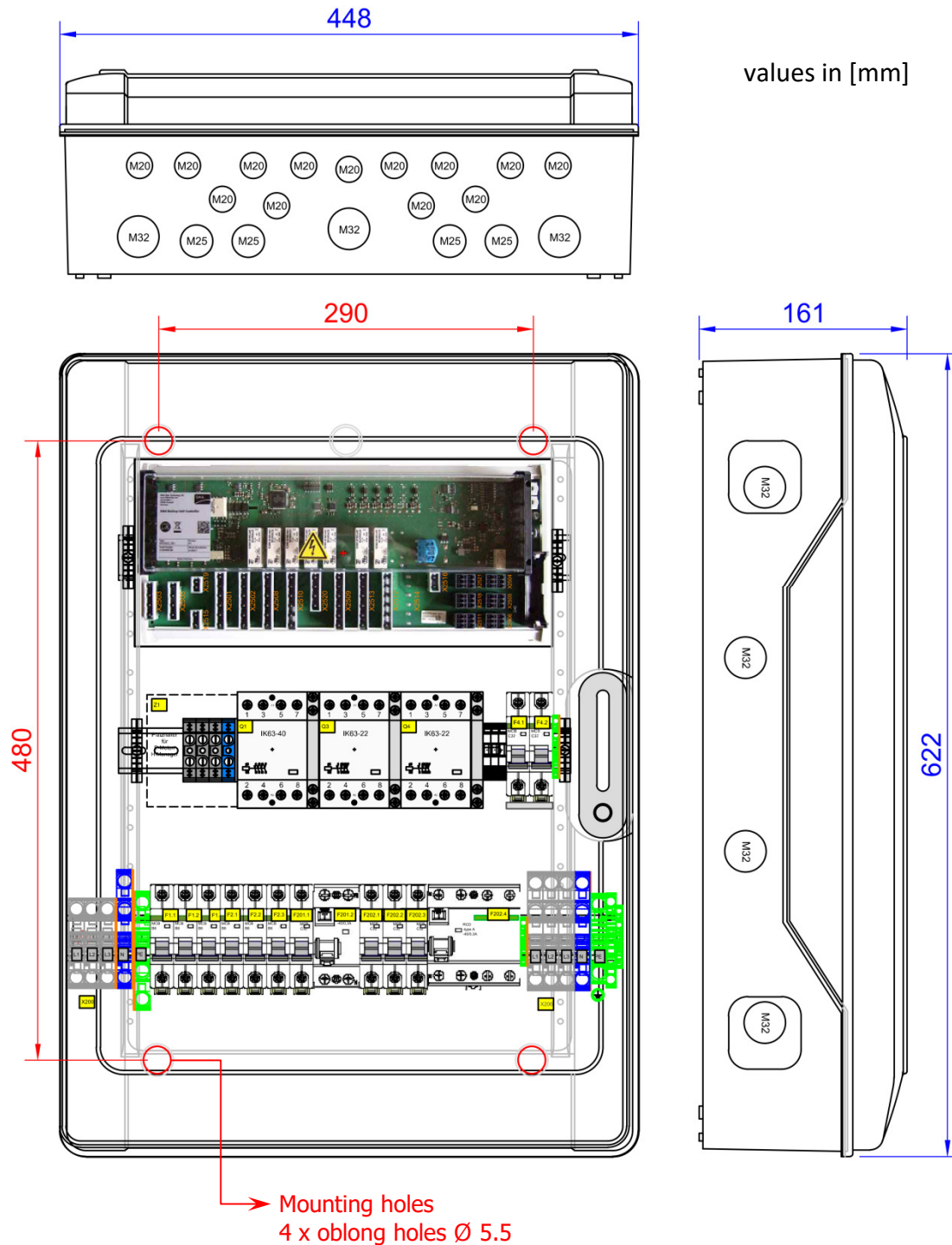







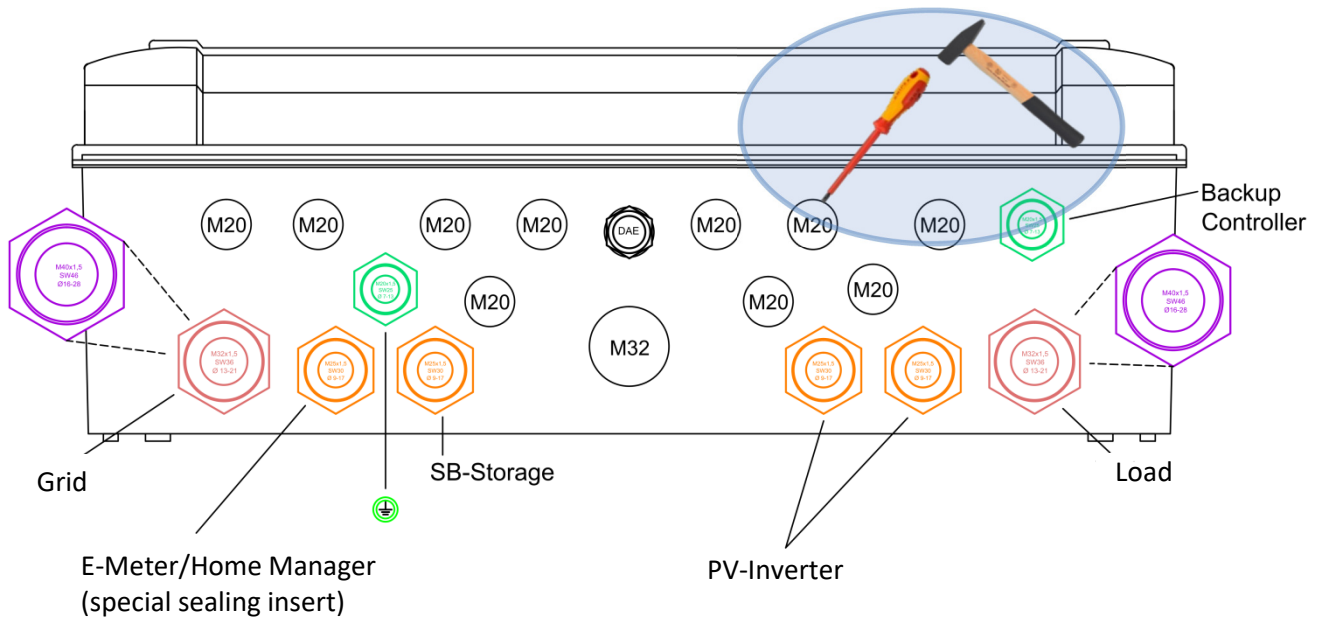

Select the correct mode of mounting, depending on the mounting surface, for example 4 x expansion anchor „S8“ + 4 x chipboard screw  $\varnothing$ 5.5



### 5.3.2 Cable entry and conductor cross sections - Model No. 10012945

**RECOMMENDATION:** Use the "bottom" knockouts











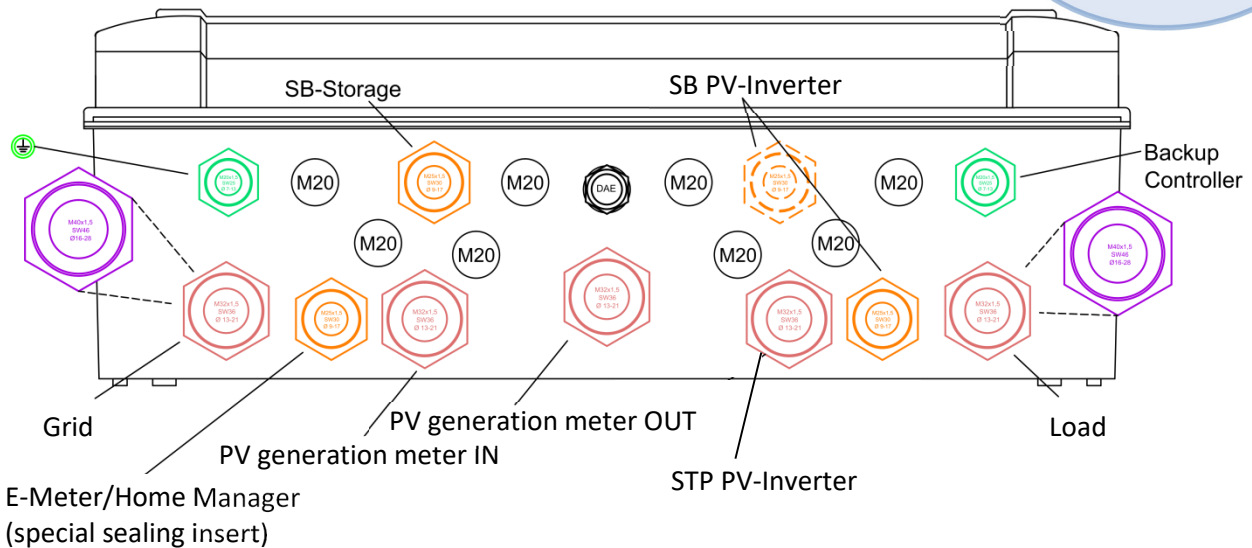
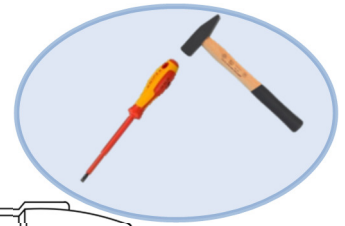

| Screw fitting  | to terminal strip/connection                        | Cable cross-section (Cu)                                    | Cable type/conductor e.g. |
|--|---|---|---------------------------|
|  M40<br> M32 | X200/X206 mains supply/loads                        | 16(25) mm <sup>2</sup>                                      | NYN 4(5) x 16(25)         |
|  M25  | X201 - SB Storage                                   | *4 mm <sup>2</sup>  | NYN 3 x 4                 |
|  M25  | X202 - PV inverter                                  | *4 mm <sup>2</sup>  | NYN 3 x 4                 |
|  M25  | Home Manager/E-Meter (split sealing insert f. RJ45) | -/-   | CAT 5/7e                  |
|  M20  | Main equipotential bonding                          | 16(25) mm <sup>2</sup>                                      | NYM 1x16                  |
|  M20  | Communication cable                                 | See SMA requirements - Chapter 6.5 in the SB Storage manual |                           |

\* If installing on insulated walls, e.g. in cavity walls filled with mineral wool, polystyrene or the like, the minimum cross-section (Cu) of **6 mm<sup>2</sup>** must be used!

### 5.3.3 Cable entry and conductor cross sections - Model No. 10012856

**RECOMMENDATION:** Use the "bottom" knockouts



| Screw fitting  | to terminal strip/connection                        | Cable cross-section (Cu)                                    | Cable type/conductor e.g. |
|--|---|---|---------------------------|
| <br>M40<br><br>M32 | X200/X206 mains supply/loads                        | 16(25) mm <sup>2</sup>                                      | NYN 4(5) x 16(25)         |
| <br>M32   | X202.1 - STP PV inverter                            | *4 mm <sup>2</sup>  | NYN 5 x 4                 |
| <br>M32   | X202.2/X202.3 - PV generation meter                 | 6(10) mm <sup>2</sup>                                       | NYN 5 x 6(10)             |
| <br>M25   | X201 - SB Storage                                   | *4 mm <sup>2</sup>  | NYN 3 x 4                 |
| <br>M25   | X202.1 - SB PV inverter                             | *4 mm <sup>2</sup>  | NYN 3 x 4                 |
| <br>M25   | Home Manager/E-Meter (split sealing insert f. RJ45) | -/-   | CAT 5/7e                  |
| <br>M20   | Main equipotential bonding                          | 16(25) mm <sup>2</sup>                                      | NYM 1x16                  |
| <br>M20   | Communication cable                                 | See SMA requirements - Chapter 6.5 in the SB Storage manual |                           |

\* If installing on insulated walls, e.g. in cavity walls filled with mineral wool, polystyrene or the like, the minimum cross-section (Cu) of **6 mm<sup>2</sup>** must be used!

## 6. Connection area - terminal arrangement

### 6.1 Power connection - Model No. 10012945

\* e = single wire; f = fine wire; f+AE = fine wire + ferrule

| Terminal strip  | Connection                 | Conductor cross-section max. [mm <sup>2</sup> ] Cu | Stripping length [mm] | Litz wire*  |
|---|----------------------------|--|-----------------------|-------------|
| X200 Spring clamp   | Mains supply "Grid"        | 16<br>25   | 18-20                 | e/f+AE<br>F |
| X206 Spring clamp   | Lasten "Load"              | 16<br>25   | 18-20                 | e/f+AE<br>F |
| X201 Cage clamp RCD<br>PE Spring clamp  | SB-Storage                 | 6(10)  | 10-12<br>13-15        | e/f/f+AE    |
| X202 Cage clamp RCD<br>PE Spring clamp  | PV inverter                | 6(10)  | 10-12<br>13-15        | e/f/f+AE    |
| PE  Spring clamp | Main equipotential bonding | 16<br>25   | 18-20                 | e/f+AE<br>F |

Tightening torque  3.5 Nm  
1.2 Nm

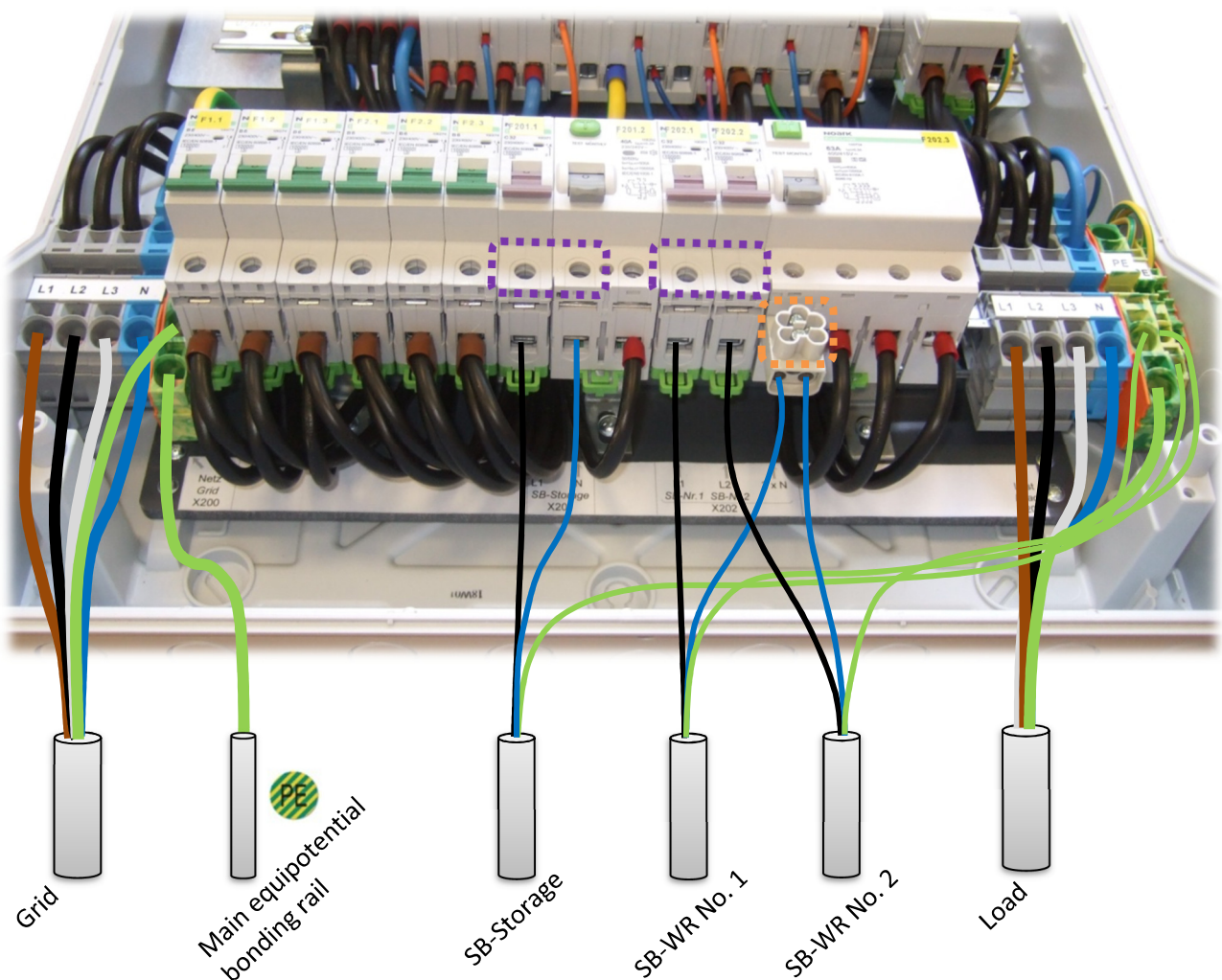

## 6.2 Power connection - Model No. 10012856

\* e = single wire; f = fine wire; f+AE = fine wire + ferrule

| Terminal strip  | Connection                    | Conductor cross-section max. [mm <sup>2</sup> ] Cu | Stripping length [mm] | Litz wire*  |
|---|-------------------------------|--|-----------------------|-------------|
| X200 Spring clamp   | Mains supply "Grid"           | 16<br>25   | 18-20                 | e/f+AE<br>F |
| X206 Spring clamp   | Lasten "Load"                 | 16<br>25   | 18-20                 | e/f+AE<br>F |
| X201 Cage clamp RCD<br>PE Spring clamp  | SB-Storage                    | 6(10)  | 10-12<br>13-15        | e/f/f+AE    |
| X202.1 Cage clamp RCD<br>PE Spring clamp  | PV inverter (STP- or SB Type) | 6(10)  | 10-12<br>13-15        | e/f/f+AE    |
| X202.2 Screw terminal<br>X202.3<br>PE Spring clamp  | PV generation meter           | 10   | 10-12                 | e/f/f+AE    |
| PE  Spring clamp | Main equipotential bonding    | 16<br>25   | 18-20                 | e/f+AE<br>F |



**If using a PV Meter:  
Remove the jumpers!**

**Tightening torque**



**3.5 Nm  
1.2 Nm**

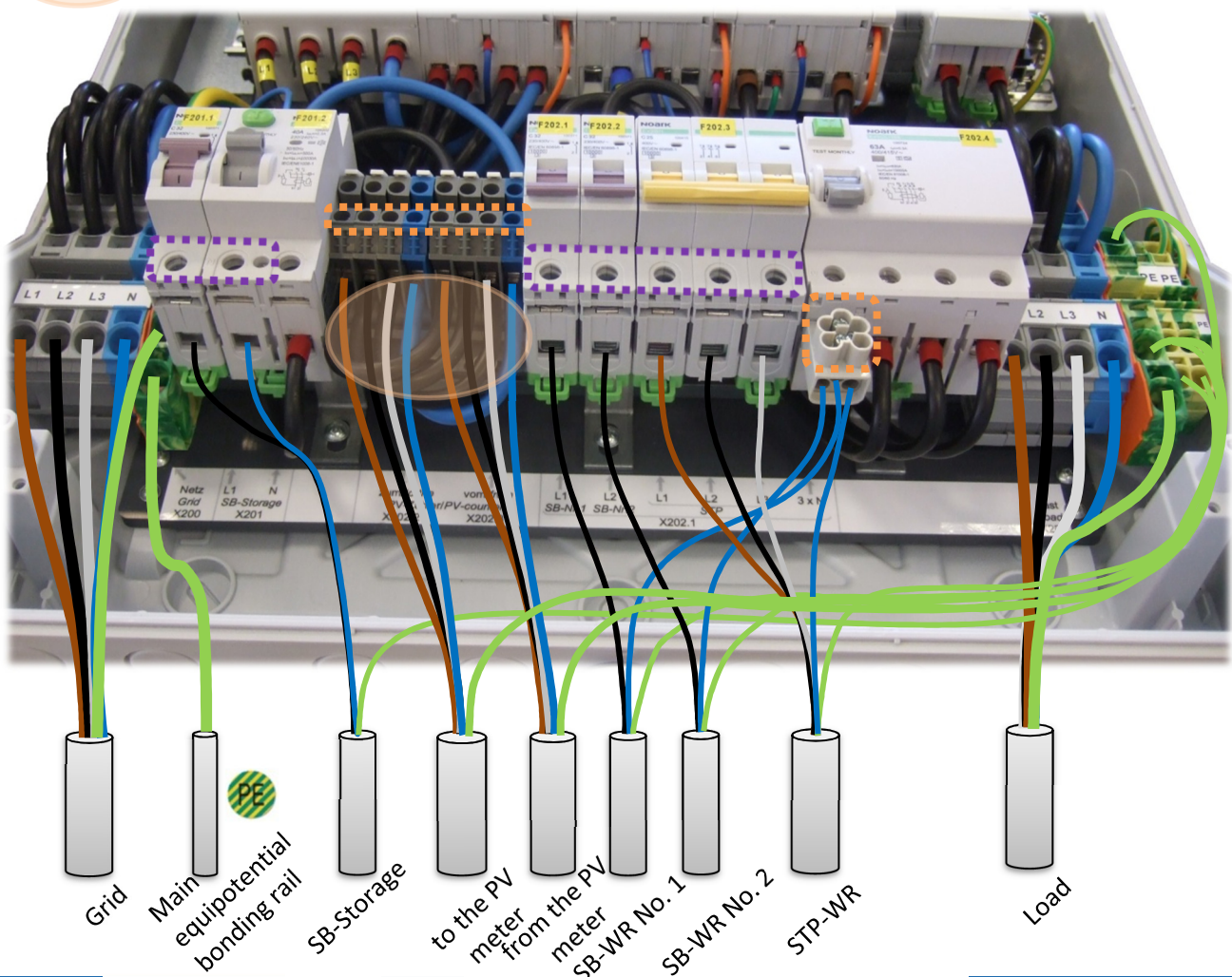

### 6.3 Connection SMA Backup Controller



When using the communication cable to the SMA Backup Controller, observe the exact specification in the SB-Storage Inverter manual (Chapter 6.5!): here a short version:

- at least CAT 5e; shielded
- conductor cross-section 0.25 mm<sup>2</sup> to 0.34 mm<sup>2</sup>
- Maximum cable length between the automatic transfer switch and the SB Storage: 10 m!

The connection plug is already fitted in the predetermined slot "X2504" on the Backup Controller!

Catches "up"!



Belegung der Klemmleiste

| Klemmleiste | Position | Belegung     |
|-------------|----------|--------------|
| A           | A        | Nicht belegt |
| B           | B        | Enable       |
| C           | C        | GND          |
| D           | D        | CAN L        |
| E           | E        | CAN H        |
| F           | F        | +12 V        |

 = ONE paired wire (twisted pair!)

#### Cables makeup

- strip the cable by 50-60 mm
- strip the insulation from the required single wires by 6 mm each
- partially strip the cable at a length (from the end) of approx. 200mm by 15-20 mm (for shield clamping on shield rail)

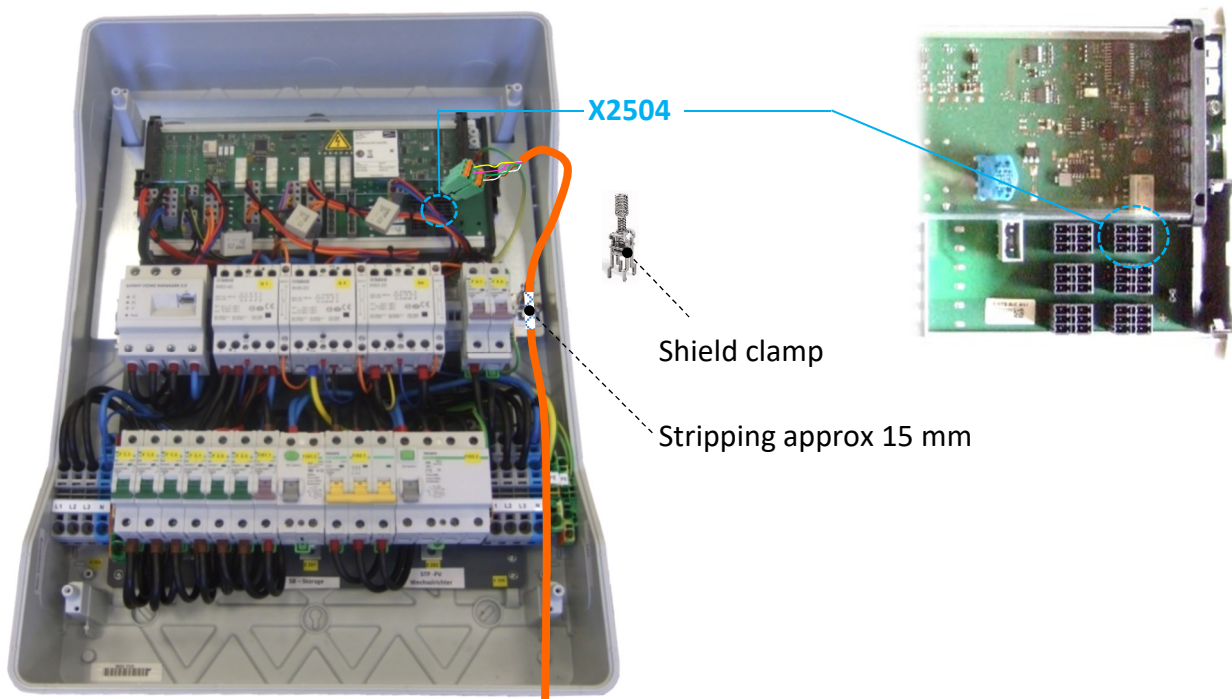

## 7. AC wiring

### 7.1 Connection to the grid supply/public grid



The following conditions generally apply in Germany for connection to the low-voltage network. TAB 2007 -BDEW- (but please always keep yourself informed about the specific network connection conditions of your network operator):

At the terminal strip X200 the connection to the power supply network is made on the X200 terminal strip. A separate PE must be routed (from the domestic junction box) to a TN-C system of the network operator) for both the TT system and a TN-S system. DIN VDE 0100, Part 444 specifies that a separate PE must be connected!

L1/L2/L3 and N (coming from the last overcurrent protection device or main line branch terminal in front of the measuring device and the power distributor - Point 6.2.4 - TAB 2007) are connected to the X200 terminal strip.

The automatic transfer switch requires a backup fuse of

**less than/equal to  $\leq 63$  A**

If the existing meter backup fuses exceed this value, you must provide additional safety in the post-meter area!

In this regard, please note the short-circuit selectivity of the meter fuses to these downstream safety devices!

We recommend a cable with a cross-section of, for example, NYY 4x16 mm<sup>2</sup> as being suitable for this backup fuse.



## 7.2 Connection to the building's distribution box (low-voltage main distribution) - consumers

The terminal block X206 connects L1/L2/L3/N/PE of the connection cable to the domestic distribution board (or "NSHV" - low voltage main distribution board).

In this regard, please note that the nominal cross-section of the cable must also be selected in accordance with the mains-side fuse (see 7.1).

### Consumers in the network operation

In the network operation, only the personal protection installed in the house distribution determines the protective measure against an electric shock in the consumer circuits!

The term "**thermal throughput**" = rated power

Make sure that the thermal throughput, as specified in the technical data, is not exceeded.

$$P_{\text{Throughput}} = \sum (+P_{\text{drawn}}) + (-P_{\text{feed}})$$

here, for example, balancing operation via 3-phase (simplified representation)

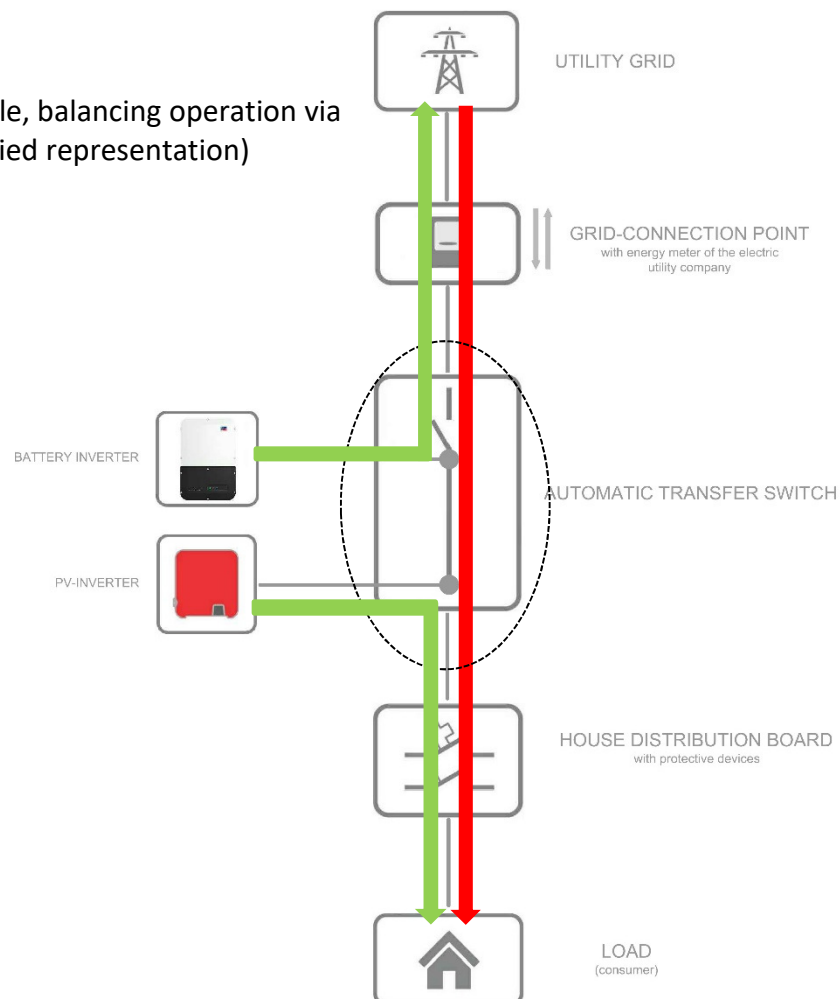

## Consumers in backup power mode

In backup power mode as well, only the personal protection installed in the house distribution determines the protective measure against an electric shock in the consumer circuits!

The earthing system in off-grid mode (= backup power) is a TN-C-S system. This ensures the earthing device installed in the automatic transfer switch.



In backup power mode, only the Sunny Boy Storage can trigger the circuit breakers in the house distribution. In this regard, please observe the relevant SMA system documentation.

### 7.3 Connecting the Sunny Boy Storage battery inverter

The Sunny Boy Storage connections are equipped with the following protective devices in the automatic transfer switch:

- Circuit breaker type "C" and nominal value **32 A**
- Residual current circuit breaker type A; 300 mA

The minimum conductor cross-section (Cu) required for the connection cable is: **4 mm<sup>2</sup>**



According to VDE 0100-520 Bbl2: 2010-10, this cross-section can be kept for all installation types, with the following exception:

If installing on insulated walls, e.g. in cavity walls filled with mineral wool, polystyrene or the like, the minimum cross-section (Cu) of **6 mm<sup>2</sup>** must be used!

Always use at least the indicated minimal conductor cross-section for all types of Sunny Boy Storage. Decisive here is not the power class of the inverter, but the nominal value of the circuit breaker installed in the automatic transfer switch!

## 7.4 Connecting the PV inverter(s)

Depending on the version of the automatic transfer switch can use

- up to two single phase PV inverters
- and additionally, a three-phase PV inverter (NO support in backup power mode!)

the PV inverters do not have to be connected in the automatic transfer switch.

### Preferred single-phase models

- SMA Sunny Boy 3.0/3.6/4.0/5.0
- maximum of TWO single-phase inverters, per net Phase (L1, L2) ONE inverter is connected

The battery inverter is hardwired to the grid phase L1 within the automatic transfer switch. In this regard, see also the installation instructions for Sunny Boy Storage at [www.sma.de](http://www.sma.de)

The connection of the two single-phase PV inverters is hard wired to the grid phase L1 and L2 within the automatic transfer switch.

If **one** single-phase PV inverter is connected, it should\* be clamped to L1.

If **two** single-phase PV inverters are connected, the less efficient PV inverter should be clamped to L1 and the higher-performance inverter to L2.

### Preferred 3 phase models

- SMA Tripower - product range 3.0/4.0/5.0/6.0/8.0/10.0 or
- SMA Tripower - product 5000TL - max. 12000TL

### GENERAL

The connections for the PV inverter are equipped with the following protective devices in the automatic transfer switch:

- Residual current circuit breaker Type A; 300 mA (selective)
- Circuit breaker "C" type
  - Rated value **32 A** for the single-phase inverters
  - Rated value **25 A** for the three-phase inverters

The minimum conductor cross-section (Cu) required for the connection cable is: **4 mm<sup>2</sup>**



As with the PV inverters, the following apply for connecting the Sunny Boy Storage:

According to VDE 0100-520 Bbl2: 2010-10, this cross-section can be kept for all installation types, with the following exception:

If installing on insulated walls, e.g. in cavity walls filled with mineral wool, polystyrene or the like, the minimum cross-section (Cu) of **6 mm<sup>2</sup>** must be used!

\* Unless otherwise specified by the network operator!

Always use at least the indicated minimal conductor cross-section for all types of PV inverters mentioned. Decisive here is not the power class of the inverter, but the nominal value of the circuit breaker installed in the automatic transfer switch!



Changing/replacing the circuit breaker must only be carried out by a qualified electrician!

#### 7.4.1 Combination options - PV inverters

For stable backup power mode, the ratio of the Sunny Boy Storage to the installed PV inverter power\* must be observed!

SMA recommends a ratio, or a design factor, of approx. 1:1.3

$$\frac{\sum \text{Rated power PV-inverter [kVA]}}{\text{Rated power SB-Storage [kVA]}} \leq 1.3$$

This ratio can also be higher. The following influencing factors play a role here:

- local yield situation/PV irradiation or weather (installed PV inverter power does not always match PV output power)
- limited active power setting by country specification at the PV inverter (e.g. 4,6 KVA according to VDE-AR-N 4105)
- Battery charging state (if the battery is full, it can absorb less excess PV energy)
- Behaviour of the connected load loads (large load changes can affect the backup current stability)

For example, it is also possible to use one Sunny Boy 5.0 on a Sunny Boy Storage SBS 3.7 or two Sunny Boy 5.0 on one SBS 5.0 in the backup power system. However, brief interruptions in the backup power system can occur in the case of large load jumps.

\* single-phase PV inverters that support backup power mode

## 7.4.2 Connecting a PV-generation meter

Here, the country-specific regulations and guidelines are to be observed. In Germany, the relevant general requirements are set out in Section 61 of the Law for the Expansion of Renewable Energies (EEG 2014). A generation meter is generally not needed for a PV system output of up to 7.69 kWp or with PV systems up to 10 kWp and a maximum expected annual output of up to 10 MWh.

But if you need to integrate a PV generation meter, you can easily connect it to the automatic transfer switch. To do this, remove the jumper wires at the corresponding terminals. The maximum clampable conductor cross-section for connecting the PV meter is **10 mm<sup>2</sup>** (Cu).

## 8. Connecting the Home Manager/Energy-Meter

Connect a network cable (recommendation: at least the quality -Twisted Pair "Cat. 5e" -) to the network connection of the SMA Home Manager or Energy Meter.

Use the M25 screw connection with the split sealing insert (accessory pack) for the cable entry!

Pass the power cord through the pre-drilled cover strips



The position of the hole can vary (depending on the model).

## 9. Phase coupling



In the backup power mode, the automatic transfer switch offers the possibility of supplying consumers which are not connected to the phase, if the SB storage physically feeds the backup current. The AC coupling of a possible second connected single-phase PV inverter for the backup power mode takes place here as well. The phase coupling is activated via circuit breakers "F4.1" and "F4.2" and contactor Q4.

Activate F4.1: Phase coupling from L1 to L2  
 Activate F4.2: Phase coupling from L1 to L3

Of course, an operating mode WITHOUT phase coupling is expressly permitted! In this case, the two above-mentioned circuit breakers are NOT activated!

Please attach a sticker in the house distribution box (automatic distributor), which indicates the use of a phase coupling, even if the phase coupling, on the basis of discussion with the system operator, is not used. The operator could later decide otherwise and activate the circuit breaker. This sticker is not included in the automatic transfer switch delivery.

Make absolutely sure that **no** three-phase loads are connected in backup mode, and especially in phase coupling. Explain this point explicitly to the system operator during the acceptance/ system handover in order to prevent later damage.



Electric oven: The individual hobs of an electric oven are 1-phase loads, which are operated between the outer conductors L1/ L2/L3 against "N".

However, in backup power mode with phase coupling, the currents in the neutral conductor of the supply line of the oven can add up to a higher value than the permissible outer conductor current (no 120° phase offset - the neutral currents add up - risk of fire!). This situation could occur if several hobs are operated simultaneously. It is your responsibility as a qualified electrician to ensure safe operation of the electric oven in backup power mode. Suitable measures could include:

- Protecting the neutral in the appropriate circuit with a separate circuit breaker (if single-pole circuit breakers are used).
- Replacing a three-pole circuit breaker with a four-pole ("all-pole") circuit breaker, which also protects the neutral conductor against overcurrent and short circuit



Fig.: ABL

## 10. Commissioning the automatic transfer switch and backup power system



The commissioning of the automatic transfer switch and the backup power system is reserved exclusively for the electrician!

**Basis for commissioning: Specifications, notes and descriptions in the current “Sunny Boy Storage” operating manual from SMA.**

### Requirements

- The automatic transfer switch is mounted securely
- All necessary cables are correctly mounted and connected
- PE is connected to the main equipotential busbar
- All insulation and functional tests required by VDE 0100-600 or national specifications have been carried out

### Procedure

- Activate the circuit breakers and residual current circuit breakers in the automatic transfer switch: Take note of the information in point 9 before activating the two circuit breakers for the phase coupling.

- Use „Sunny Boy Storage“ operating manual**
  - Chapter 8.7      Checking or Disabling Battery-Backup Operation
  - Chapter 8.14    Configuring Battery and Automatic Transfer Switching Device
  - Chapter 8.15    Disabling Battery Charging by PV System in Battery-Backup Operation Mode

## After successful commissioning

- ☑ After successful commissioning and screwing the housing cover to the side of the housing, please attach the sticker in the accessory pack:

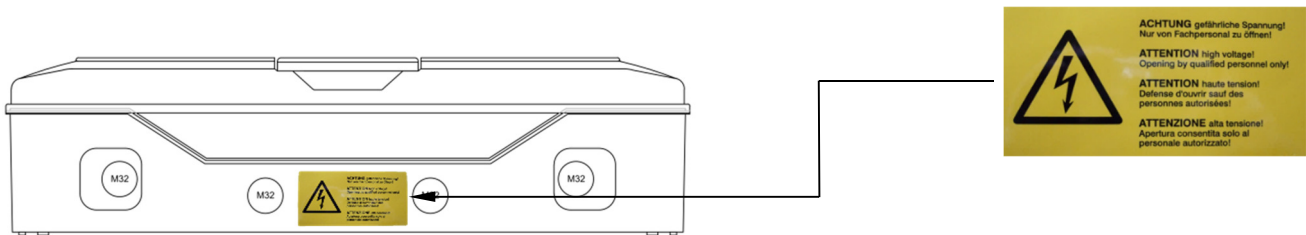

- ☑ Attach the reference to an off-grid-capable storage system to the domestic junction box or to the central meter in order to indicate the danger of a voltage being present even if the mains power supply is switched off! (The sticker is included in the delivery)

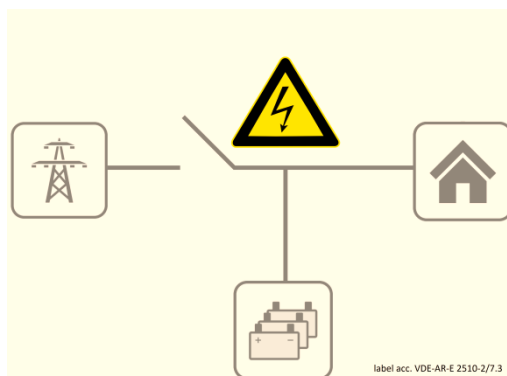

## 11. Troubleshooting

If there are technical problems with our products, please contact:

enwitec electronic GmbH & Co.KG  
 Tel. +49 8725 9664-0  
[info@enwitec.eu](mailto:info@enwitec.eu)

We need the following information to meet your specific query:

- Model number, version number (e.g. 10012856\_V1.4)
- Serial number



Please use the operating instructions for "Sunny Boy Storage 3.7/5.0/6.0" from SMA as the basis for troubleshooting. The automatic transfer switch is communicatively connected to the SB-Storage via CAN bus and provides corresponding event information.

Chapter 11 of the SMA Operating Instructions provides you with detailed information about the relevant event numbers, possible causes and remedies.



The following event numbers correspond to the status of the SMA documentation on the day the automatic transfer switch manual was issued and are not subject to the update service of enwitec electronic GmbH & Co.KG!

Therefore, always use the current version of the operating instructions for the Sunny Boy Storage for troubleshooting!

|      |   |
|------|---|
| 7359 | <p><b>Update BUC</b></p> <p>The SMA Backup Unit Controller that is installed in the automatic transfer switch has been updated successfully.</p>  |
| 7360 | <p><b>⚠ QUALIFIED PERSON</b></p> <p><b>Update BUC failed</b></p> <p><b>Corrective measures:</b></p> <ul style="list-style-type: none"> <li>• Ensure that the communication between SMA Backup Unit Controller and the inverter functions perfectly.</li> <li>• Ensure that the cable requirements of the communication cable for the communication between the SMA Backup Unit Controller and the inverter have been met.</li> <li>• Retry update.</li> <li>• If this message is displayed again, contact the Service (see Section 14, page 124).</li> </ul>  |
| 7623 | <p><b>⚠ QUALIFIED PERSON</b></p> <p><b>Communication to backup module disrupted</b></p> <p>The communication between the inverter and the SMA Backup Unit Controller in the automatic transfer switch is disrupted.</p> <p><b>Corrective measures:</b></p> <ul style="list-style-type: none"> <li>• Ensure that the cable requirements of the communication cable for the communication between the SMA Backup Unit Controller and the inverter have been met.</li> <li>• Retry update.</li> <li>• Carry out communication test.</li> <li>• If the communication test was successful, contact the manufacturer of the automatic transfer switch. If the communication test failed, contact the Service (see Section 14, page 124).</li> </ul> |

|      |   |
|------|---|
| 9204 | <p><b>⚠ QUALIFIED PERSON</b></p> <p><b>AC overvoltage backup (fast)</b><br/>Voltage in the battery-backup grid too high or step changes in load too high in the battery-backup grid.</p> <p><b>Corrective measures:</b></p> <ul style="list-style-type: none"> <li>• Check whether there is a new firmware version available for the inverter.</li> <li>• If a newer version is available, perform the firmware update.</li> <li>• If no new firmware version is available, contact Service.</li> </ul> |
| 9205 | <p><b>⚠ QUALIFIED PERSON</b></p> <p><b>AC overvoltage backup (slow)</b><br/>Voltage in the battery-backup grid too high or step changes in load too high in the battery-backup grid.</p> <p><b>Corrective measures:</b></p> <ul style="list-style-type: none"> <li>• Check whether there is a new firmware version available for the inverter.</li> <li>• If a newer version is available, perform the firmware update.</li> <li>• If no new firmware version is available, contact Service.</li> </ul> |
| 9206 | <p><b>⚠ QUALIFIED PERSON</b></p> <p><b>Short circuit in backup</b><br/>Loads in the battery-backup grid too high.</p> <p><b>Corrective measures:</b></p> <ul style="list-style-type: none"> <li>• Reduce loads.</li> <li>• Contact Service.</li> </ul>  |
| 9207 | <p><b>⚠ QUALIFIED PERSON</b></p> <p><b>Backup module bimetal switch</b><br/>Automatic transfer switch error.</p> <p><b>Corrective measures:</b></p> <ul style="list-style-type: none"> <li>• Contact the automatic transfer switch manufacturer.</li> </ul>   |
| 9208 | <p><b>⚠ QUALIFIED PERSON</b></p> <p><b>Backup module relay error [d0]</b><br/>Relay in the automatic transfer switch faulty.</p> <p><b>Corrective measures:</b></p> <ul style="list-style-type: none"> <li>• Contact the automatic transfer switch manufacturer.</li> </ul>   |
| 9209 | <p><b>⚠ QUALIFIED PERSON</b></p> <p><b>N-PE monitoring backup module</b></p> <p><b>Corrective measures:</b></p> <ul style="list-style-type: none"> <li>• Contact the automatic transfer switch manufacturer.</li> </ul>   |
| 9211 | <p><b>⚠ QUALIFIED PERSON</b></p> <p><b>Backup module overtemperature</b></p> <p><b>Corrective measures:</b></p> <ul style="list-style-type: none"> <li>• Check the installation of the automatic transfer switch.</li> <li>• Contact the automatic transfer switch manufacturer.</li> </ul>   |

|       |   |
|-------|---|
| 9217  | <b>⚠ QUALIFIED PERSON</b>   |
|       | <p><b>Output supply voltage of the battery interface module too low [b4]   b5]</b></p> <p><b>Corrective measures:</b></p> <ul style="list-style-type: none"> <li>• Check whether the plugs for connecting the battery and the automatic transfer switch are correctly inserted.</li> <li>• If this message is displayed again, contact the Service (see Section 14, page 124).</li> </ul> |
| 9218  | <b>⚠ QUALIFIED PERSON</b>   |
|       | <p><b>Battery interface module output communication error [b4] [b5]</b></p> <p><b>Corrective measures:</b></p> <ul style="list-style-type: none"> <li>• Check whether the plugs for connecting the battery and the automatic transfer switch are correctly inserted.</li> <li>• Carry out communication test.</li> </ul>  |
| 9219  | <b>⚠ QUALIFIED PERSON</b>   |
|       | <p><b>Battery interface module output communication error [b4] [b5]</b></p> <p><b>Corrective measures:</b></p> <ul style="list-style-type: none"> <li>• Make sure that only one node each is connected to the connections for the communication cables of the battery and the automatic transfer switch.</li> </ul>   |
| 9223  | <p><b>Backup operation</b><br/>The battery-backup function is enabled.</p>  |
| 29254 | <p><b>Input power for SPS too low</b><br/>The battery's state of charge is insufficient to supply the loads in secure power supply operation.</p>   |

Source: SMA

## 12. Disconnecting the power supply to the automatic transfer switch

### DANGER

- Disconnect input terminal strip X200 from the power supply: Secure the fuse elements between the power supply (RU) and the switching device, check that there is no voltage and secure against reconnection.
  
- Disconnect input terminal strip X201 from the power supply: Decommission the PV inverter (see the system documentation from the manufacturer!); Check that there is no voltage and secure against reconnection
  
- Disconnect input terminal strip X202 from the power supply: Decommission the battery inverter SB Storage (see the system documentation from the manufacturer!); Check that there is no voltage and secure against reconnection
  
- Disconnect input terminal strip X206 from the power supply: Secure the fuse elements between the PV system (if inverters are not directly connected to the automatic transfer switch!) and the automatic transfer switch, check that there is no voltage and secure against reconnection.

### 13. Maintenance and Cleaning

You should check the function and safety of the automatic transfer switch on a regular basis. Regulation 3 Section 5 of the German Statutory Accident Insurance (DGUV) stipulates that electrical installations and stationary electrical equipment in "operating facilities, rooms and facilities of special kind" (DIN VDE 010-712 for PV systems) must be checked once a year by a qualified electrician!

The basic functionality of the built-in residual current circuit breaker (RCCB) must be regularly checked (= "Test Button") by the system operator.



A complete test of the residual current circuit breaker must be carried out by the electrician in accordance with the specifications of VDE 0100-600 before the first commissioning. This test includes proof of compliance with switch-off times and rated differential currents according to VDE 0100-410.

The system operator should test the backup power mode at least once a year.



The contactors Q1 and Q4 (= mains isolating contactor and phase coupling contactor) can suffer permanent contact damage, especially in the case of **major short circuits** (caused, for example, by errors in the commissioning of the backup power system).

These contactors are classified according to "assignment type 1" in accordance with IEC 60947-4-1 (VDE 0660-102) and must not endanger persons and equipment in the event of a short circuit but must not be suitable for further operation without repair and/or (partial) replacement.

Therefore, replace the contactor in case of doubt (after commissioning) and/or a presumption of contact damage on the main contacts.

#### Visual examination

Depending on the installation site and the environmental conditions, a more or less severe external contamination of the housing can occur. In this case, carefully clean it with a damp cleaning cloth.

- Do not use aggressive cleaners!
- Do not open the hinged lid of the housing!

## 14. Storage

### 5.1 Requirements for the installation site

- The site is dry
- Ambient temperature is between -25 °C and + 55 °C
- When stored for a maximum of 24 hours, an ambient temperature of max. +70 °C is permissible!

## 15. Disposal

Dispose of the automatic transfer switch in accordance with the current disposal regulations for electronic waste!

## 16. Technical data:

### 16.1 Model No. 10012945

| RATINGS  |   |                      | GENERAL                                   |   |             |
|--|---|----------------------|---|---|-------------|
| Rated voltage  | 3PH [V]   | 230/400              | Width                                     | [mm]  | 448         |
| Rated insulation voltage                                     | [V]   | 400                  | Height                                    | [mm]  | 622         |
| Operating frequency  | [Hz]  | 50                   | Depth                                     | [mm]  | 161         |
| Max. prospective* short-circuit current                      | [kA]  | 10                   | Weight approx.                            | [kG]  | 12          |
| Permitted earthing system                                    |   | TT/TN-S              | Operating temperature range               | [°C]  | -25...+40   |
| Max. mains-side fuse   | [A]   | 63(gL/gG)            | Temperature - Transport/Storage           | [°C]  | -25...+55   |
| Max. thermal throughput                                      | [kW]  | 20                   | Short-term max. 24 hours                  | [°C]  | +70 °C      |
| Standby-losses approx.                                       | [W]   | 15                   | Condensing humidity permitted             | •/-   | -           |
| <b>CIRCUIT BREAKERS</b>                                      |   |                      | Humidity - permissible range              | [%]   | 5...95      |
| F1.1/2/3   | Backup-Controller   | 3 x B6A              | Max. Installation altitude m.a.s.l.       | [m]   | 2000        |
| F2.1/2/3   | Backup-Controller   | 3 x B6A              | Protection class IP (EN 60529)            |   | 65          |
| F4.1/2   | Phase coupling  | 2 x C32A             | Outdoor-suitability                       | •/-   | -           |
| F201.1   | SB-Storage  | 1 x C32A             | Installation type (indoor/outdoor)        |   | indoor      |
| F202.1/2   | PV-inverter   | 2 x C32A             | Protection class (EN61140)                |   | II          |
| <b>- RESIDUAL CURRENT CIRCUIT BREAKER type "A"</b>           |   |                      | Housing material                          |   | PC          |
| F201.2   | SB-Storage  | 300 mA               | RoHS compliant (2011/65/EU)               |   | •           |
| F202.3   | PV-inverter (selective)   | 300 mA               | Housing paint (similar) RAL               |   | 7035        |
| <b>CONTACTORS IEC/EN61095; IEC/EN 60947-1; IEC 60947-5-1</b> |   |                      | Mounting method (wall, base, floor)       |   | Wall        |
| Q1 "Mains isolation"   | AC1[A]  | 63                   | Cover                                     |   | transparent |
| Q3 "Earthing device"   | AC1[A]  | 63                   | Type of closure (Actuation)               |   | Tool-less   |
| Q4 "Phase coupling"  | AC1[A]  | 63                   | <b>STANDARDS</b>                          |   |             |
| Control voltage  | AC/DC[V]  | 230                  | Switchgear assembly                       | EN 61439-1  | •           |
| Hum free   |   | Yes                  |   | EN 61439-2  | •           |
| <b>CONNECTION/TERMINALS - max. cross-section (Cu)</b>        |   |                      | Operability by ordinary persons           | EN 61439-3  | •           |
| X200   | Network   | [mm <sup>2</sup> ]   | 16(25)                                    | <b>BACKUP POWER SYSTEM</b>  |             |
| X206   | Load  | [mm <sup>2</sup> ]   | 16(25)                                    | Maximum overload currents (rms value) [A]                                       |             |
| X201   | SB-Storage  | [mm <sup>2</sup> ]   | 6(10)                                     | Sunny Boy Storage SBS 3.7-10  | 20          |
| X202   | PV-inverter   | [mm <sup>2</sup> ]   | 6(10)                                     | Sunny Boy Storage SBS 5.0-10  | 28          |
| X2504  | Backup Controller - Communication cable according to SMA specifications |                      |   | Sunny Boy Storage SBS 6.0-10  | 32          |
| <b>FITTINGS AND TERMINAL RANGE [mm]</b>                      |   |                      | Max. Output leakage current (<200 μs) [A] |   | 198         |
| X200/X206  | M32/alternative M40   |                      | 13-21/16-28                               | Voltage to ground in the event of short-circuit currents [V]                    | <20         |
| PE   | M20   |                      | 6-13                                      | Short-term current carrying capacity of the off-grid earthing for 5 seconds [A] | 240         |
| X201   | M25   |                      | 9-17                                      | Long-term current load of the off-grid grounding [A]                            | 63          |
| X202   | M25   |                      | 9-17                                      | Time span until switch-off when the overload current is exceeded [ms]           | 80          |
| X2504  | M20   |                      | 6-13                                      | Time span until shutdown when exceeding 55 A peak (short circuit) [μs]          | 250         |
| E-Meter/ Home Manager  | M25   | split seal for plugs |   | <b>MISCELLANEOUS</b>  |             |
|  |   |                      | Customs number                            |   | 85371098    |
|  |   |                      | SMA Backup Controller - Part Number       |   | 10012490    |

## 16.2 Model No. 10012856

### RATINGS

|   |         |           |
|---|---------|-----------|
| Rated voltage                           | 3PH [V] | 230/400   |
| Rated insulation voltage                | [V]     | 400       |
| Operating frequency                     | [Hz]    | 50        |
| Max. prospective* short-circuit current | [kA]    | 10        |
| Permitted earthing system               |         | TT/TN-S   |
| Max. mains-side fuse                    | [A]     | 63(gL/gG) |
| Max. thermal throughput                 | [kW]    | 20        |
| Standby-losses approx. [W]              |         | 15        |

### CIRCUIT BREAKERS

|          |                         |           |
|----------|-------------------------|-----------|
| F1.1/2/3 | Backup-Controller       | 3 x C6A   |
| F2.1/2/3 | Backup-Controller       | 3 x C6A   |
| F4.1/2   | Phase coupling          | 2 x C32A  |
| F201.1   | SB Storage              | 1 x C32A  |
| F202.1/2 | SB - PV-inverter (1PH)  | 2 x C32A  |
| F202.3   | STP - PV-inverter (3PH) | 1 x 3C25A |

### - RESIDUAL CURRENT CIRCUIT BREAKER type "A"

|        |                         |        |
|--------|-------------------------|--------|
| F201.2 | SB Storage              | 300 mA |
| F202.4 | PV-inverter (selective) | 300 mA |

### CONTACTORS IEC/EN61095; IEC/EN 60947-1; IEC 60947-5-1

|                 |                   |        |    |
|-----------------|-------------------|--------|----|
| Q1              | "mains isolation" | AC1[A] | 63 |
| Q3              | "Earthing device" | AC1[A] | 63 |
| Q4              | "Phase coupling"  | AC1[A] | 63 |
| Control voltage | AC/DC[V]          | 230    |    |
| Hum free        |                   | Yes    |    |

### CONNECTION/TERMINALS - max, cross-section (Cu)

|          |   |                    |        |
|----------|---|--------------------|--------|
| X200     | Network   | [mm <sup>2</sup> ] | 16(25) |
| X206     | Load  | [mm <sup>2</sup> ] | 16(25) |
| X201     | SB Storage  | [mm <sup>2</sup> ] | 6(10)  |
| X202.1   | PV-inverter   | [mm <sup>2</sup> ] | 6(10)  |
| X202.2/3 | PV-generation meter   | [mm <sup>2</sup> ] | 10     |
| X2504    | Backup Controller - Communication cable according to SMA specifications |                    |        |

### FITTINGS AND TERMINAL RANGE [mm]

|                          |                           |                         |
|--------------------------|---------------------------|-------------------------|
| X200/X206                | M32/alternative M40       | 13-21/16-28             |
| PE                       | M20                       | 6-13                    |
| X201                     | M25                       | 9-17                    |
| X202.1                   | M25 (SB-WR); M32 (STP-WR) | 9-17/13-21              |
| X202.2                   | M32                       | 13-21                   |
| X202.3                   | M32                       | 13-21                   |
| X2504                    | M20                       | 6-13                    |
| E-Meter/<br>Home Manager | M25                       | split seal<br>for plugs |

### GENERAL

|                                     |                  |             |
|-------------------------------------|------------------|-------------|
| Width                               | [mm]             | 448         |
| Height                              | [mm]             | 622         |
| Depth                               | [mm]             | 161         |
| Weight approx.                      | [kg]             | 12          |
| Operating temperature range         | [°C]             | -25...+40   |
| Temperature - Transport/Storage     | [°C]             | -25...+55   |
| Short-term max. 24 hours            | [°C]             | +70 °C      |
| Condensing humidity permitted       | •/-              | -           |
| Humidity - permissible range        | [%]              | 5...95      |
| Max. Installation altitude m.a.s.l. | [m]              | 2000        |
| Protection class IP (EN 60529)      |                  | 65          |
| Outdoor-suitability                 | •/-              | -           |
| Installation type                   | (indoor/outdoor) | indoor      |
| Protection class                    | (EN61140)        | II          |
| Housing material                    |                  | PC          |
| RoHS compliant (2011/65/EU)         |                  | •           |
| Housing paint (similar) RAL         |                  | 7035        |
| Mounting method (wall, base, floor) |                  | Wall        |
| Cover                               |                  | transparent |
| Type of closure                     | (Actuation)      | Tool-less   |

### STANDARDS

|                                 |            |   |
|---------------------------------|------------|---|
| Switchgear assembly             | EN 61439-1 | • |
|                                 | EN 61439-2 | • |
| Operability by ordinary persons | EN 61439-3 | • |

### BACKUP POWER SYSTEM

|   |            |     |
|---|------------|-----|
| Maximum overload currents (rms value) [A]                                       |            |     |
| Sunny Boy Storage   | SBS 3.7-10 | 20  |
| Sunny Boy Storage   | SBS 5.0-10 | 28  |
| Sunny Boy Storage   | SBS 6.0-10 | 32  |
| Max. Output leakage current (<200 μs) [A]                                       |            | 198 |
| Voltage to ground in the event of short-circuit currents [V]                    |            | <20 |
| Short-term current carrying capacity of the off-grid earthing for 5 seconds [A] |            | 240 |
| Long-term current load of the off-grid grounding [A]                            |            | 63  |
| Time span until switch-off when the overload current is exceeded [ms]           |            | 80  |
| Time span until shutdown when exceeding 55 A peak (short circuit) [μs]          |            | 250 |

### MISCELLANEOUS

|                                     |          |
|-------------------------------------|----------|
| Customs number                      | 85371098 |
| SMA Backup Controller - Part Number | 10012490 |



## 17. Disclaimer

All warranty, liability and compensation claims for damages of any kind are excluded if they are due to one or more of the following causes:

- Transport damage
- Inappropriate or improper use of the product
- Operation of the product in an unsuitable environment
- Operation of the product in disregard to the relevant statutory safety provisions at the site of use
- Ignoring the warning and safety instructions in all documents relevant to the product
- Operating the product under faulty safety and protection conditions
- Unauthorized modification or repair of the product
- Malfunctioning of the product due to the influence of connected or neighbouring devices outside the legally permissible limits
- Disasters and force majeure

## 18. Manufacturer's declaration of conformity with EU regulations

### EC Declaration of Conformity

The products                    Automatic transfer switch

**Bezeichnung**                    3PH\_SMA\_1ST6\_1STP12\_2SB5\_BBDAP\_20KW\_1PH\_PREP\_DACH\_1.x  
*Type designation*                3PH\_SMA\_1ST6\_X\_2SB5\_BBDAP\_20KW\_1PH\_PREP\_DACH\_1.x

*Order number*                    10012856 / 10012945

*Manufacturer*                    enwitec electronic GmbH & Co. KG; Scherrwies 2 - 84329 Rogglfing

*Description*                    Battery-Backup-Distribution

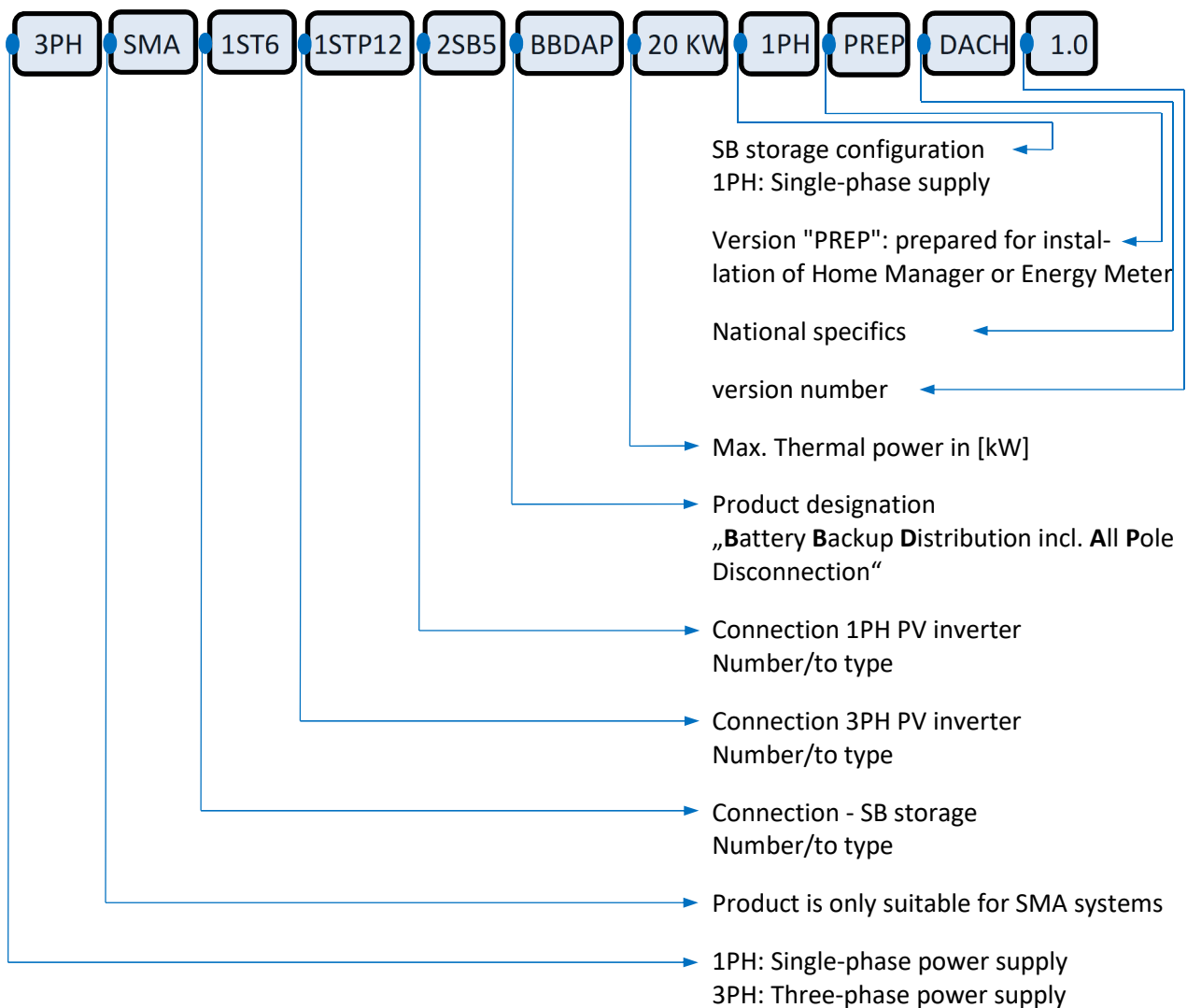

to which this declaration relates is in conformity to the following standard(s) or normative document(s):

Standard                    **IEC/EN 61439-1**  
                                  **IEC/EN 61439-2**  
                                  **IEC/EN 61439-3**

*National Standard and application rule*

**VDE-AR-E 2510-2**

and is in accordance with the provisions of the following EC-directive(s):

**Low voltage directive (LVD) 2014/35/EU**

**Restriction of Hazardous Substances Directive (RoHS) 2011/65/EU**

Year of affixing CE-marking:                    **2018**

Date of issue:                    **04.07.2018**

enwitec electronic GmbH & Co. KG  
Scherrwies 2  
84329 - Rogglfing - Germany  
Tel.: +49 8725 9664-10  
[info@enwitec.eu](mailto:info@enwitec.eu)

A handwritten signature in black ink, appearing to read "Johann Wimmer".

NAME/ Signature

Johann Wimmer  
CEO

## Our products



### **PV connection technology**

Generator connection boxes, AC/DC distribution units, protective circuitry, monitoring, grid and system protection



### **Energy storage solutions**

Island and emergency backup systems, battery protection, automatic transfer switches



### **Contract manufacturing**

Electrical assemblies, switch cabinet construction, processing of casings, cable manufacture, assembly of complex components for power storage solutions



#### **enwitec electronic GmbH & Co.KG**

Scherrwies 2  
84329 Rogglfing  
Germany

Telephone +49 8725 9664-0  
Telefax +49 8725 966-96  
info@enwitec.eu  
www.enwitec.eu

The text and illustrations correspond to the technical status at the time of printing, changes are reserved. Despite careful processing, the accuracy of the information provided is not guaranteed. Liability is excluded.

© enwitec 2018